

THE ANALYST

The Journal of The Society of Public Analysts and other Analytical Chemists

Publication Committee

Chairman: J. R. NICHOLLS, D.Sc., F.R.I.C.

N. L. ALLPORT, F.R.I.C.
F. W. F. ARNAUD, F.R.I.C.
A. L. BACHARACH, M.A., F.R.I.C.
R. C. CHIRNSIDE, F.R.I.C.
H. E. COX, D.Sc., Ph.D., F.R.I.C.
BERNARD DYER, D.Sc., F.R.I.C.
F. W. EDWARDS, F.R.I.C.
B. S. EVANS, M.B.E., M.C., D.Sc., F.R.I.C.
E. HINKS, M.B.E., B.Sc., F.R.I.C.

E. B. HUGHES, D.Sc., F.R.I.C.
D. W. KENT-JONES, B.Sc., Ph.D., F.R.I.C.
S. ERNEST MELLING, F.R.I.C.
G. W. MONIER-WILLIAMS, O.B.E.,
M.C., Ph.D., F.R.I.C.
A. MORE, I.S.O., A.R.C.S.,
A.R.T.C., F.R.I.C.
W. H. SIMMONS, B.Sc., F.R.I.C.
ERIC VOELCKER, A.R.C.S., F.R.I.C.
K. A. WILLIAMS, B.Sc., F.R.I.C.

Hon. Secretary:

L. EYNON, B.Sc., F.R.I.C.
7-8, Idol Lane, E.C.3

Hon. Treasurer:

G. TAYLOR, F.R.I.C.
Peek House, 20, Eastcheap, E.C.3

Editor: C. AINSWORTH MITCHELL, D.Sc., M.A., F.R.I.C.
The Close, Weedon, Aylesbury, Bucks.

Secretary and Assistant Editor: J. H. LANE, B.Sc., F.R.I.C.
7-3, Idol Lane, E.C.3

Abstractors

S. G. CLARKE, D.Sc., Ph.D., A.R.I.C.
B. S. COOPER, B.Sc., F.Inst.P.
E. B. DAW, B.Sc., A.R.I.C.
J. GRANT, Ph.D., M.Sc., F.R.I.C.
A. O. JONES, M.A., F.R.I.C.

J. W. MATTHEWS, Ph.D., D.I.C., F.R.I.C.
E. M. POPE, B.A., B.Sc.
F. A. ROBINSON, M.Sc.Tech., F.R.I.C.
W. R. SCHOELLER, Ph.D., F.R.I.C.
D. R. WOOD, F.R.I.C.

Published for the Society by
W. HEFFER & SONS LTD., Cambridge, England

IMPORTANT NOTICE TO SUBSCRIBERS

(Other than Members of the Society).

All Subscriptions and renewals to the Journal should be sent
through a Bookseller or direct to

W. HEFFER & SONS LTD., CAMBRIDGE, ENGLAND.

Price 3/6; or to Subscribers in advance, post free, 35/- per annum.

N.B.—Members send their subscriptions to the Hon. Treasurer.

FOR
ACCURACY
AND RAPIDITY

WHATMAN
High Grade
FILTER PAPERS
ARE ENTIRELY DEPENDABLE



Each grade is
distinctively labelled

STOCKED BY
LABORATORY
FURNISHERS
THROUGHOUT
THE WORLD

IN SEALED
BOXES

THE WHATMAN
range covers all
requirements of
the chemist in
every branch of
industry and re-
search.

Made only by
W. & R. BALSTON, Ltd.
KENT

In the event of difficulty in obtaining
supplies, free samples, or copy of our
descriptive booklet and price list, please
write the Sole Sales Representatives:

H. REEVE ANGEL & COMPANY, LTD.
9, BRIDEWELL PLACE, LONDON, E.C.4.

SAVE PRECIOUS TIME-USE PRECIOUS METALS

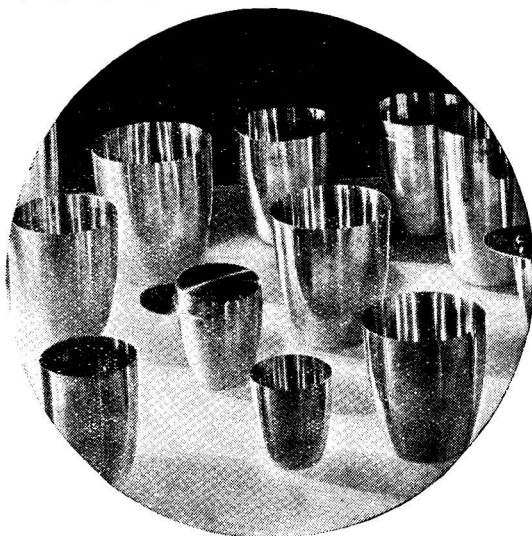

Every Chemist in a well-equipped
laboratory has realised the advantages
and economies obtained from the
use of platinum apparatus.

JMC
PLATINUM CRUCIBLES
AND DISHES

are of sturdy construction, give
accurate determinations, enjoy long
life, and may usually be repaired
and remodelled as new after many
years of trustworthy service.

Publication No. 45 gives details of
JMC Platinum Crucibles and Dishes.
No. 47 provides much helpful in-
formation on the use and maintenance
of Platinum Laboratory Apparatus.
Copies free upon request.

JOHNSON, MATTHEY & CO., LIMITED

HEAD OFFICE

73/83 HATTON GARDEN, LONDON, E.C.1

Prepare your Media with



It is free from contaminating organisms and toxic by-products.
It contains no fermentable carbohydrate.

Unlike many of the older peptones it provides in saline solution *alone* a complete medium for a wide variety of bacteria.

With the addition of dextrose, a saline solution produces an excellent growth of pneumococci, hæmolytic streptococci, and organisms of the coli typhoid and welchii groups.

No serum need be added when it is used for typing streptococci for the fermentation reactions.

It conforms to the requirements of the Indol test.

Potent diphtheria, tetanus, welchii and other toxins can be obtained with media containing this peptone.

It has low copper and iron content.

Bacteriological Peptone (Evans) is issued in 5 and 16-oz. amber bottles with bakelite screw caps

BILE SALTS and other culture media also available.

Prices and full details will be sent on application to :—
London: Home Medical Dept., Bartholomew Close, E.C.1
Liverpool: Home Medical Dept., Speke, Liverpool, 19

MEDICAL EVANS RESEARCH.

Made at the Evans Biological Institute, by
EVANS SONS LESCHER & WEBB, LIMITED

M33

QUICKFIT DOES IT BETTER—

ANTI-FOAMING SPLASH HEAD

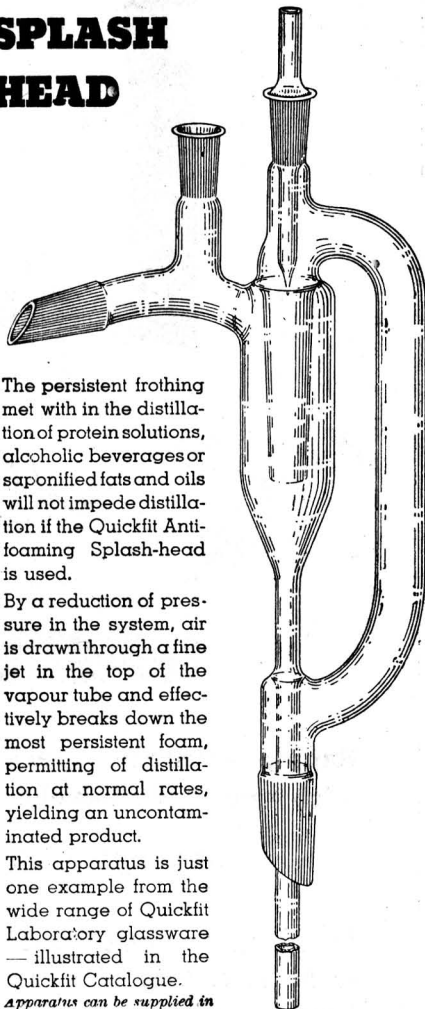

The persistent frothing met with in the distillation of protein solutions, alcoholic beverages or saponified fats and oils will not impede distillation if the Quickfit Anti-foaming Splash-head is used.

By a reduction of pressure in the system, air is drawn through a fine jet in the top of the vapour tube and effectively breaks down the most persistent foam, permitting of distillation at normal rates, yielding an uncontaminated product.

This apparatus is just one example from the wide range of Quickfit Laboratory glassware — illustrated in the Quickfit Catalogue.

Apparatus can be supplied in Pyrex, Phoenix or Huxal glass.

QUICKFIT

LABORATORY GLASSWARE WITH STANDARD INTERCHANGEABLE GROUND GLASS JOINTS

QUICKFIT & QUARTZ LTD

TRIPLEX WORKS, KING'S NORTON, BIRMINGHAM

London Office: 1 Albemarle Street, W.1

Phone Regent 8171

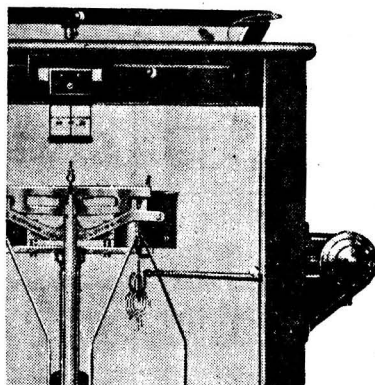

THE FINEST

Quality

IN THE WORLD

Rapid, accurate precision weighing made possible with the "Multi-weight" device

Oertling design saves Chemists' time!

All fractional weights added automatically and read off from scale graduated in fifths of a mg. without opening the balance case. No loose weights below 1 gram. Capacity 100 grams. Ask for specification 62 FM.

NOTE THE ADDRESS:—

Oertling

TELEPHONE
WELbeck 2273

L. OERTLING LTD.
110 GLOUCESTER PLACE,
LONDON W.1.
(Near BAKER STREET STATION)

FOUNDED
IN LONDON
BEFORE 1847

TAS/OR.223

A THIRD EDITION OF
'ANALAR' STANDARDS for LABORATORY CHEMICALS

has been published

Price: 5s. 0d. Postage extra.

The monographs in this book set out in the clearest possible form precise information as to the purity of the materials concerned, together with a description of the analytical technique by means of which the assurance of such purity is established.

THE BRITISH DRUG HOUSES LTD., LONDON, N.1

CHELSEA POLYTECHNIC

MANRESA ROAD, LONDON, S.W.3

Principal: F. J. HARLOW, M.B.E., Ph.D., B.Sc.

Head of Chemistry Department:

J. C. CROCKER, M.A., D.Sc., F.R.I.C.

A course of lectures and practical work on
**THE CHEMISTRY AND MICROSCOPY
 OF FOOD, DRUGS AND WATER**

will be given by D. C. GARRATT, Ph.D., F.R.I.C.
 September to July, 1944-5.

The Course is based on the Syllabus of the Examination for the Fellowship of the Royal Institute of Chemistry (Branch E), and includes Analysis and Microscopy of Food, Drugs and Water; Toxicological Analysis; Acts and Regulations relating to Food, Drugs and Poisons.

Lecturers will be in attendance on FRIDAY, September 22nd, 6-8 p.m., to advise Students.

Full particulars may be obtained on application to the Principal.

UNIVERSITY OF MANCHESTER

Faculty of Technology

Particulars of Degree Courses in General Chemical Technology, Chemical Engineering, Metallurgy and Assaying, Fermentation Processes (including Brewing) Foodstuffs, Fuels, Colouring Matters, and Electro-Chemistry, and of the Post-Graduate Diploma Course in Chemical Engineering, will be supplied on request by the Registrar, College of Technology, Manchester, 1.



VITREOSIL FILTERING AND IGNITION CRUCIBLES

We can now supply VITREOSIL crucibles for filtration and subsequent ignition at temperatures up to 1000° C. Filtration without asbestos mats, ignition and weighing are all done in the same crucible. Laboratory workers will appreciate the value of these great advantages of the VITREOSIL filtering crucible.

THE THERMAL SYNDICATE LIMITED

Head Office: Wallsend, Northumberland
 London Depot: 12-14, Old Pye Street, Westminster, S.W.1

REIGATE



BRAND

Registered Trade Mark

NATURAL ISOLATES:**ESSENTIAL OILS:****SYNTHETICS:****FLOWER OILS:**
 'Phone
Reigate 2242

**Citral, Eugenol, Geraniols,
Ionones, Methyl Ionones,
Hydroxycitronellal**

 'Grams
Esswhite, Reigate

SOLE MANUFACTURERS:—

**WHITE, TOMKINS & COURAGE, LTD
REIGATE, SURREY**

Established 1841

We have made available certain Analytical Reagents with ACTUAL BATCH ANALYSIS confirmed by INDEPENDENT Analysts of the highest standing: particulars of one example are given.

★ YOU ARE INVITED TO COMPARE THE PURITY WITH THAT GUARANTEED BY ANY COMPETING MAKER.

JUDACTAN ANALYTICAL REAGENT

POTASSIUM DICHROMATE A.R.
K₂Cr₂O₇

Mol. Wt. 294.21

ACTUAL BATCH ANALYSIS

(Not merely maximum impurity values)

Batch No. 18667	
Potassium Dichromate	99.9%
Chloride (Cl)	0.0025%
Sulphate (SO ₄)	0.005%
Aluminium (Al)	0.0015%
Calcium (Ca)	0.0025%
Sodium	No Reaction
Moisture	0.04%

The above analysis is based on the results, not of our own Control Laboratories alone, but also on the confirmatory Analytical Certificate issued by independent Consultants of international repute

The General Chemical & Pharmaceutical Co., Ltd.
Chemical Manufacturers, Judex Works, Sudbury, Middlesex

THE ANALYST

PROCEEDINGS OF THE SOCIETY OF PUBLIC ANALYSTS
AND OTHER ANALYTICAL CHEMISTS

The Hypophosphorous Acid Reduction of Tin. An Improved Procedure and Notes on its Mechanism*

By B. S. EVANS, M.C., M.B.E., D.Sc., F.R.I.C., AND D. G. HIGGS

THE research which forms the basis of the following paper was undertaken in the first instance to provide some definite data on the subject of titration of tin in presence of much larger amounts of antimony. Statements had been made that the end-point under these conditions was so transitory as to be uncertain; in addition to this, the influence of a trace of copper, with or without antimony, had always been suspect. In the early stages, however, when endeavouring to carry out fairly large (*e.g.*, 40 ml) titrations with *N*/100 iodine it became obvious to us that certain minor irregularities were liable to occur somewhat frequently, and it became necessary to investigate the causes of these before attempting further work. The process under investigation was first published in 1931.¹

METHOD—As carried out in this laboratory up to the present, details of this process are as follows. Place the soln. of tin in the flask (Fig. 1) and bring the acidity up to 1 : 1 (HCl) and the vol. to 100 ml. Add 1 ml of sat. mercuric chloride soln. and 4 g of sodium hypophosphite and place the stopper in position. Sweep out the apparatus with a rapid current of carbon dioxide for 10 min., then slightly reduce the rate of the current, place the flask on the hot plate and boil gently for 15 min. Close the tap of the funnel, open fully the tap of the carbon dioxide supply, and allow the flask to cool. Meanwhile gently boil a mixture of 20 ml of 50% citric acid soln., 10 ml of 4% potassium iodide soln., a few ml of starch soln. and 250 ml of water for 10 min. and then cool. Withdraw the glass plug from the stopper of the titration apparatus and run the other soln. (referred to below as the "diluting liquid") in through the funnel, taking care to avoid admission of air. Finally insert the jet of the burette containing the titrating liquid into the hole which formerly contained the glass plug, and titrate.

An illustration of the scope of the irregularities (which were mainly but not always negative) may be taken from a series carried out with only tin present, and under the exact conditions laid down in the original process:—Taken: 0.0250 g. Found: 0.0253, 0.0248, 0.0247, 0.0243, 0.0244, 0.0243, 0.0242 g.

Influence of Dissolved Oxygen—In view of the work of Okell and Lumsden² it was obviously necessary to attempt to find out if dissolved oxygen was the cause of the low results. Whilst, as one of the authors pointed out during the discussion on that paper, Okell and Lumsden's results were obtained under conditions far more favourable to air oxidation than those of the process under discussion, it was not to be hoped that this latter process would entirely escape the effect. Nor did it, figures such as the following being obtained:—Added: 0.240 g. Found: by *N*/10 I titration 0.0251 g; by *N*/100 I titration 0.0243 g, the lower figure being apparently due to oxygen dissolved in the larger volume of titrating liquid required. There is, however, no need to use such large vols. of titrating liquid, small vols. of stronger solns., say, *N*/10, serving equally well; the oxygen dissolved in the titrating liquid therefore, does not particularly concern us. The same cannot be said of the soln. used to dilute the reduced tin soln. after reduction: here the volume is large, approx. 300 ml, and

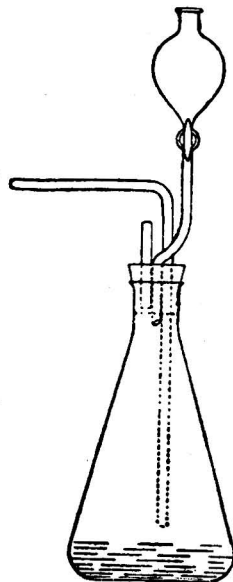

Fig. 1

* Communication from the Armaments Research Department (formerly Research Department, Woolwich).

a small volume will not do. It is true the soln. is boiled before use and this seems to lower the ultimate content of oxygen, but Okell and Lumsden have shown² that boiled water rapidly re-absorbs oxygen when cooled in presence of air. It was necessary, therefore, to try to what extent this re-dissolved oxygen caused the low results referred to above and, if possible, devise some not too complicated means of counteracting the interference. The method used throughout these experiments for ensuring absence of re-absorbed oxygen from the diluting liquid, *i.e.*, cooling the latter under carbon dioxide, was adopted because it seemed to present no loopholes for contamination; it is not to be recommended as a routine procedure on account of the extra complication. A very simple method of avoiding the difficulty will be described later (*vid. inf.*). Experiments carried out with the diluting liquid cooled in air, and others where it was cooled under carbon dioxide, immediately showed that re-absorbed oxygen is a major cause of these small errors. Two titrations made with a diluting liquid through which air had actually been bubbled gave a still lower result, providing still further confirmation.

	Tin taken g	Tin found g	Error g
Diluting liquid cooled in air	0.0100	0.00952	-0.00048
	0.0100	0.00942	-0.00058
Diluting liquid "bubbled" with air ..	0.0250	0.02365	-0.00135
	0.0250	0.02366	-0.00135
Diluting liquid cooled under CO ₂	0.0100	0.01000	nil
	0.0100	0.01000	nil

Influence of Acid Strength—As it was found that the hydrochloric acid in use was considerably weaker (sp.gr. 1.16 instead of 1.2) than that formerly used, it seemed worth while to ascertain what, if any, influence this had on the result. It was found by a number of titrations that the acid strength of the final liquid might vary between 1 and 5% of conc. hydrochloric acid per 100 ml without any decided influence on the result; in fact, it appeared as if the weaker liquids were slightly the better (*cf.* R. Höltje,³ who states that HCl strength should lie between 0.2 and 1.0%). As, however, it was found in later work that antimony is partially titrated in 1% acid, it is apparent that lowering of the acid concentration (*e.g.*, by addition of Na₂CO₃) before titration introduces far more danger than advantage. The acid concn. of the liquid in which the tin was being reduced was, however, another matter, and incomplete reduction of the tin might readily result from the hydrochloric acid strength of the reducing liquid being too low. The following errors in a series of titrations, in 3 of which the reducing liquid was 50% of conc. hydrochloric acid (sp.gr. 1.20) while the other three were 50% hydrochloric acid (sp.gr. 1.16), were obtained. Sp.gr. 1.2: +0.00004, -0.00002, +0.00001; sp.gr. 1.16: -0.00013, -0.00013, -0.00033. As the escape of acid vapour from the flask during the 15 min. boiling for reduction is apt in the normal process to be extremely variable owing to superheating effects, reduction in these expts. was carried out with flasks immersed in boiling water for 20 min. and not boiled. Under these conditions reduction was complete and very little acid was evaporated. The procedure was therefore adopted as less liable to variation throughout this research; it has been discarded in the final process because it has proved to present no real advantage over the more direct boiling.

Influence of Mercury Catalyst—When long series of titrations were attempted, using these refinements, it became evident that there were still unexplained factors; discrepancies still occurred occasionally and now slightly high results appeared from time to time. Examples of the latter are the following:—Taken: 0.0250 g. Found: 0.0253, 0.0254, 0.0256, 0.0254, 0.0254 g. Low results are readily explainable, but occasional high results were very perplexing. The only factor which had been ignored hitherto would seem to be the mercury catalyst. There appears to be at least a possibility of the formation of mercurous chloride during the process of reduction by hypophosphite, and this mercurous chloride, once formed, might function conceivably in either or both of two ways: (i) It might so obscure the mercury surface as materially to reduce the rate of reduction of the tin, by lessening the catalytic effect; (ii) It would probably be titratable with iodine, giving a tendency towards high results.

Experiments directed towards elucidating these points were as follows:

(a) One drop of metallic mercury was added in place of the usual 1 ml of mercuric chloride solution (sat.).

Taken: 0.0050 g of tin; Found: 0.0015 g of tin.

Here the greatly reduced surface of the mercury probably explains the low result.

(b) Smaller quantities of mercuric chloride soln. were used.

0.5 ml Taken: 0.0100 g of tin; Found: 0.00995 g.

0.1 ml Taken: 0.0050 g of tin; Found: 0.00236 g.

It is evident from this that the 1.0 ml prescribed is adequate but not greatly excessive, 0.1 ml yielding less than half reduction.

(c) In view of the fact that mercuric chloride in solution is largely un-ionised, it was thought that mercuric cyanide might be less prone to give mercurous chloride. Results were better but still not sufficiently concordant.

(d) An attempt was made to eliminate chlorides altogether by reducing a sulphuric acid soln. of tin in 100 ml of 1 : 3 sulphuric acid.

(1) Mercuric chloride catalyst. 0.0250 g of tin required 4.5 ml of *N*/100 (should be 42.10).

(2) Mercuric cyanide catalyst. 0.0100 g of tin required 0.5 ml of *N*/100 (should be 16.89).

The mercuric chloride was used accidentally owing to our forgetting that it was introducing chlorides. The results, however, are very interesting, inasmuch as the 10% reduction obtained with the chloride was lowered to 2% when chlorides were absent.

The results obtained so far seemed to indicate:—(i) That chlorides were necessary to the functioning of the catalyst; (ii) that the mercury was liable to be contaminated with a substance (Hg_2Cl_2 ?) which might produce results either slightly too high or slightly too low.

(e) On the assumption that mercurous chloride was the interfering substance there seemed a likelihood that if the mercury were pptd. as metal in absence of chlorides and then added to the liquid to be reduced, the formation of mercurous chloride would be extremely small, although the metal would still be in a very finely divided state. Tests carried out on this assumption proved satisfactory; the catalyst used was a solution of mercuric cyanide reduced by boiling in dil. (1 : 3) sulphuric acid with a little sodium hypophosphite; it was then added to the tin which was in solution in 1 : 1 hydrochloric acid and the process was carried out as usual. Subsequently it was found that so long as the mercury is reduced apart from the tin the interference does not seem to occur; consequently, to avoid unnecessary complication, the mercuric cyanide in the process is reduced in 1 : 1 hydrochloric acid.

The process finally adopted was as follows:

AMENDED PROCESS—Place the soln. containing the tin to be determined in the flask of the titrating apparatus, bring it to approx. 50% strength (of the strong acid sp.gr. 1.2) with hydrochloric acid and add dil. (1 : 1) hydrochloric acid to give a vol. of *ca.* 90 ml. Place 10 ml of 1 : 1 hydrochloric acid in a small beaker, add 1 ml of 1% mercuric cyanide soln. and 0.5 g of sodium hypophosphite, boil for *ca.* 1 min. and add to the tin soln. in the flask. Insert the stopper, sweep out the apparatus for 10 min. with a rapid current of carbon dioxide, leaving the tap of the funnel open and the glass plug in position. Boil gently for 15 min. over a small flame, with the carbon dioxide still passing. Close the exit tap, leaving the supply tap of the carbon dioxide open, remove from the burner, and allow to cool under pressure of the carbon dioxide.

Make up a diluting liquid from 10 ml of 4% potassium iodide soln., 20 ml of 50% citric acid soln., 250 ml of water and a few ml of 1% starch soln., boil gently for 10 min. and cool.

When both flasks are cold add 3 g of sodium bicarbonate to the diluting liquid, remove the glass plug from the stopper of the titrating apparatus, and immediately run the diluting liquid through the funnel into the flask, taking care that no air is admitted. Insert the jet of the burette carrying the titrating liquid into the hole from which the glass plug was removed, and titrate in the ordinary manner.

This modification, which is put forward for ordinary use to replace the original method,¹ was the process used in obtaining the results given in the remainder of the paper, except for two additional refinements. (i) In every expt. the diluting liquid was cooled under carbon dioxide and no bicarbonate was added; (ii) a slight modification is necessary in presence of antimony. This will be referred to later.

With regard to (i) the cooling under carbon dioxide was adopted, in this instance, to make sure of the absence of disturbing factors; it is, however, too cumbersome for normal

use, and the following trials showed that the bicarbonate addition is quite effective in eliminating the dissolved oxygen.

	Tin taken g	Tin found g	Error g
Diluting liquid cooled in air	0.0100	0.00952	-0.00048
	0.0100	0.00942	-0.00058
Diluting liquid cooled under CO ₂	0.0100	0.0100	nil
	0.0100	0.0100	nil
Diluting liquid cooled in air; 3 g of NaHCO ₃ added	0.0100	0.0100	nil
	0.0100	0.01009	+0.00009
	0.0099	0.00989	-0.00001
	0.0099	0.00983	-0.00007
Diluting liquid not boiled; 3 g. of NaHCO ₃ added..	0.0100	0.00989	-0.00011
	0.0100	0.00994	-0.00006
	0.0099	0.00986	-0.00004
	0.0099	0.00986	-0.00004

The unboiled liquid is almost as good as that which had been boiled; boiling, however, gives a slight improvement and seems safer.

The process, as described, was tested against varying amounts of tin, other metals being absent, with the following results:

Tin taken g	Titration		Tin found g	Error g
	Actual ml	Theoretical ml		
0.0100	17.00	16.84	0.01008	+0.00008
0.0090	14.95	15.16	0.00887	-0.00013
0.0080	13.30	13.47	0.00789	-0.00011
0.0070	11.94	11.79	0.00709	+0.00009
0.0060	10.25	10.10	0.00608	+0.00008
0.0050	8.25	8.42	0.00490	-0.00010
0.0040	6.80	6.74	0.00403	+0.00003
0.0030	5.05	5.05	0.00300	nil
0.0020	3.30	3.37	0.00196	-0.00004
0.0010	1.75	1.68	0.00104	+0.00004

Titration of Tin in Presence of Antimony—The difficulty introduced by antimony appears to be due to the extreme fugitiveness of the end-point at ordinary temperatures, which may lead to over-titration or even to no definite end-point at all. Cooling the liquid to as low a temperature as practicable both before and during the titration seems to give reasonably accurate results, thus:

Tin taken, g: 0.0099; antimony taken: 0.100; tin found, g: at 5° C. 0.0101; at 6° C., 0.0100; at 24° C., 0.0110; at 15° C., 0.0105.

Worse, however, than the results being generally high is their uncertainty at ordinary temperatures. Cooling to a sufficient degree is, however, a somewhat laborious process, especially during a heat wave and it was our aim to find a reagent which would sufficiently stabilise the end-point at ordinary temperatures. Many reagents were tried, but only one—ammonium oxalate—gave the effect desired; if 5 g of ammonium oxalate are added to the diluting liquid before boiling, the end-point is quite sharp at such temperatures as 20° C. The following series was carried out by the same process as for tin alone, with merely this modification:

Tin taken g	Antimony taken g	Titration		Tin found g	Error g
		Actual ml	Theoretical ml		
0.0100	0.100	16.89	16.84	0.01003	+0.00003
0.0090	0.100	15.05	15.16	0.00894	-0.00006
0.0080	0.100	13.48	13.47	0.00800	nil
0.0070	0.100	11.72	11.79	0.00696	-0.00004
0.0060	0.100	10.07	10.10	0.00597	-0.00003
0.0050	0.100	8.47	8.42	0.00502	+0.00002
0.0040	0.100	6.72	6.74	0.00399	-0.00001
0.0030	0.100	5.05	5.05	0.00300	nil
0.0020	0.100	3.35	3.37	0.00199	-0.00001
0.0010	0.100	1.65	1.68	0.00098	-0.00002

From these figures it is obvious that, in this modified process, antimony has absolutely no effect on a tin titration.

Blank—There is always a small blank to be deducted from a $N/100$ iodine titration due to the amount of iodine required to show a blue colour with the starch. This blank has been deducted from all the figures given here. One interesting fact, however, that emerged was that 0.1 g of antimony put through the complete original process, without modification, gave exactly the same blank as that done in acidified water alone and the end-point was stable. In other words, the high results and fading end-points associated with antimony seem only to be shown in presence of tin.

End-Point—The end-point obtained in these hypophosphite reductions is never permanent in the sense of remaining unchanged for several minutes, and this is especially so where antimony is present. The end-points obtained in this process, however, are perfectly sharp; the blue colour spreads throughout the liquid and remains unchanged for at least several seconds; a trace of tin still unoxidised destroys it instantaneously.

Temperature—As already stated, the unmodified procedure in presence of antimony required the liquid to be somewhat drastically cooled in order to be manageable. Expts. proved that this applies also to tin alone at a slightly higher temp., but the results are low instead of being high, thus: Tin taken, g: 0.0250; tin found, g: at 35° C., 0.0209, 0.0223, 0.0242; at 30° C., 0.0221, 0.0222. It is therefore obvious that the liquid must be quite cold before titration is performed.

Titration in Presence of Copper—In the main we confirm Okell and Lumsden's findings² that, with small amounts of copper, there is very little influence on the tin titration, but, in addition, it must be noted that, with these hypophosphite reductions, the presence of copper accelerates the fading of the end-point colour. Up to 0.003 g of copper, the end-point is still sharp, although very transient; above 0.003 g the fading is too rapid for the end-point to be reliable, and with, say, 0.01 g there is no end-point at all. It was of considerable interest to find out if an otherwise negligible amount of copper would upset the titration in presence of considerable amounts of antimony; the following figures were obtained:

Tin taken g	Antimony added g	Copper added g	Titration		Tin found g	Error g
			Actual ml	Theoretical ml		
0.0050	—	0.0030	8.74	8.42	0.00519	+0.00019
0.0050	—	0.0027	8.55	8.42	0.00507	+0.00007
0.0050	—	0.0009	8.06	8.42	0.00478	-0.00022
0.0050	0.100	0.0030	8.45	8.42	0.00502	+0.00002
0.0050	0.100	0.0027	8.39	8.42	0.00498	-0.00002
0.0050	0.100	0.0009	8.64	8.42	0.00513	+0.00013
0.0050	0.100	0.0003	8.45	8.42	0.00502	+0.00002

It is evident from the above that copper below 0.003 g causes but little disturbance either in presence or in absence of antimony; the error is slightly greater than usual in three instances, but this is probably attributable to the rapid fading of the end-point. This trial has its value because it proves that the presence of accidental traces of copper (*e.g.*, after a separation) has no measurable influence on the tin titration; this is a point which, so far as we are aware, has not been established before.

Catalytic Effect of Mercury—This effect has, as far as we know, never been explained. The effect itself has been adopted by Feigl¹⁴ to provide a delicate test for mercury. We would suggest that the real catalyst is a minute trace of mercurous chloride formed on the surface of the mercury; at any rate, the presence of chlorides appears to be necessary to its adequate functioning.

Reduction of Tin in Presence of Antimony by Metallic Reductants—Tin seems generally to be brought to the stannous condition prior to titration by reduction with a variety of metals. Of these, lead seems to be far superior to the others, but quite a number are employed, and each has its advocates. They have, however, one bad feature in common; they all reduce antimony to the metallic form. It has been shown:

- (i) that pptd. antimony co-precipitates appreciable amounts of tin^{5,6};
- (ii) that finely divided antimony will, in the cold, re-reduce tin which has been titrated^{6,7};
- (iii) that where antimony itself is used as the reductant, results either high or low can be obtained at will, according to the fineness of the grinding⁶;
- (iv) that where copper is present, also in solution, copper and tin are pptd. together, presumably as a compound.⁶

In view of the above findings, it would appear that where correct results are obtained, in presence of antimony or copper, with a metallic reductant, they cannot be true results at all but are due to a balance of errors.

The principal advantage claimed for the method of reduction which is the subject of this paper is that, except for a trace of mercury, which is inert, there is no metallic surface present in the liquid at all either before or after reduction.

Determination of Tin in Lead Alloys—From the foregoing it is evident that whilst the method already published,^{8,9} for the solution of lead alloys in perchloric acid and subsequent titration of tin, remains valid: (a) it is essential that care should be taken that the hydrochloric acid concentration in the reduction liquid is up to the prescribed strength; (b) it is desirable that the mercury catalyst should be prepared in the way given in this paper and not as in the former ones^{8,9}; (c) sodium bicarbonate should be added to the cooled diluting liquid before it is run into the titrating flask; (d) in presence of antimony, ammonium oxalate should be added to the diluting liquid before boiling.

SUMMARY—(a) The causes of minor errors in the hypophosphite reduction method for tin have been investigated and simple modifications for their elimination have been tested. These modifications, which appear to be entirely effective, are:

- (i) Ensuring that the acid concentration of the liquid during reduction is actually 1 : 1 of the strong acid (sp.gr. 1.2); (ii) the use of mercuric cyanide instead of mercuric chloride and its separate reduction to mercury before its addition to the tin solution; (iii) the addition to the diluting liquid, after cooling and before running into the tin solution, of 3 g of sodium bicarbonate; (iv) when antimony is present, the addition of 5 g of ammonium oxalate to the diluting liquid before boiling.

(b) It has been shown that, using these modifications, tin may be accurately titrated in presence of much larger amounts of antimony or of not more than 0.003 g of copper or of both together.

It is not practicable to publish all the results of titrations, made in the course of this research, which ran into hundreds; but care has been taken that those given are representative.

This paper is published by permission of the Director-General of Scientific Research and Development, Ministry of Supply.

REFERENCES

1. Evans, B. S., *ANALYST*, 1931, **56**, 171.
2. Okell, F. L., and Lumsden, J., *Id.*, 1935, **60**, 803.
3. Höltje, R., *Z. anorg. Chem.*, 1931, **198**, p. 287.
4. Feigl, F., "*Specific and Special Reactions*," trans. by R. F. Oesper, Elsevier Pub. Coy., New York, 1940, p. 77.
5. Järvinen, K., *Z. anal. Chem.*, 1923, **62**, 184.
6. Clarke, S. G., *ANALYST*, 1931, **56**, 82.
7. Hourigan, H. F., *Id.*, 1936, **61**, 329.
8. Evans, B. S., *Id.*, 1932, **57**, 555.
9. British Standard Specification for Lead and Lead Alloys for Cable Sheathing, 801-1938. Appendix C.

March, 1944

The Rapid Photometric Determination of Tellurium in Tellurium Copper Alloys

By P. B. CROSSLEY, F.R.I.C.

(Read at the Meeting, May 3, 1944)

WITH the increasing production of high speed machining copper it became evident that a method for the determination of tellurium more rapidly than by the usual gravimetric procedure would be desirable. The tellurium is present in quantities up to 1%, and a determination was required, within the day, on large batches for control purposes. For this reason an investigation was instituted and the method detailed below was evolved. It will be seen that considerable economy was effected in reagents and time, the min. time previously required being 6 hours,¹ whilst this method takes only 2 hours.

SOLUTIONS REQUIRED—(1) *Nitric acid*—50% v/v. (2) *Stannous chloride*—Dissolve 30 g of stannous chloride in 350 ml of conc. hydrochloric acid, warming slightly, and add 100 ml of water. (3) *Thiourea (thiocarbamide)*—Dissolve 100 g in 1000 ml of water and, after complete solution, add 60 ml of conc. nitric acid.

PRINCIPLE—Reduction is effected by the use of stannous chloride soln. Copper is not removed, but all interference therefrom is suppressed by using thiourea in acid solution.

METHOD—Accurately weigh 1 g of the alloy drillings into a 250 ml conical flask. Add 20 ml of 50% nitric acid and close the mouth of the flask with a small funnel to prevent losses due to spray. Allow 10 to 15 min. for solution to become complete, and place on the hot plate for a further 15 min. so that the liquid just boils.

Cool, dilute to 200 ml in a graduated flask, mix thoroughly, and pipette 10 ml of this soln. into a 200 ml beaker. From burettes add exactly 15 ml of thiourea soln., 60 ml of water and 15 ml of stannous chloride soln. Mix well and transfer a portion of this soln. to the 4-cm cell of Hilger's "Spekker" Absorptiometer; then, using Spectrum violet filters (No. 601) and water: water: 1 setting, measure the absorption and read the % of tellurium from a calibration graph.

Note I—Selenium interferes if present in quantities greater than 0.01%. The effect of smaller amounts is ignored for control purposes.

Note II—The calibration graph may be constructed in either of two ways:—(a) by testing on the Spekker Absorptiometer a number of samples previously analysed by the gravimetric procedure and plotting the drum differences obtained against the tellurium percentages: (b) by taking one sample containing a known amount of tellurium (say 0.7%), and weighing, instead of 1 g, a series of 0.7, 0.8, 0.9, 1.0, 1.1 g; then, calculating on the basis of an assumed in-weight of 1 g, percentages of tellurium over the range 0.49%, 0.56%, 0.63%, 0.70% and 0.77% are obtained, which are plotted against the drum differences.

Note III—The photo-electric absorptiometer naturally suggested itself as the best means of measuring the turbidities produced, but comparisons may be made visually in the usual manner. In that event the 10-ml fraction will be run from the pipette into a Nessler tube, the same additions made, and the colour of the resulting soln. matched against that of standards prepared by adding appropriate amounts of a standard tellurium soln. to Nessler tubes each containing 10 ml of 2% cupric nitrate soln., 15 ml of thiourea soln., 55 ml of water and 15 ml of stannous chloride soln.

Note IV—The method can be used to determine tellurium in amounts ranging from 0.1 to 1%. It is possible to extend the effective range to amounts outside those limits by taking suitable quantities of the sample.

Note V—Close consideration was given to the use of the following stabilisers—(1) starch, (2) gum arabic, and (3) gum tragacanth, but no special advantages were observed. To obtain results within the degree of accuracy mentioned above their use does not appear essential.

In conclusion it may be stated that this turbidimetric method has been used for many hundreds of determinations, and has given consistently good results against tellurium determinations by the standard normal gravimetric method. An accuracy of 0.02 to 0.03% of tellurium on the sample was obtained.

This method has been developed in the laboratories of Messrs. Enfield Rolling Mills, Ltd. I wish to thank the Directors for permission to publish this paper, and also Messrs. N. J. Stead and M. S. Naik, who have carried out the experiments.

REFERENCE

1. Willis, U. F., *ANALYST*, 1941, **66**, 414.
- 43, SLADES HILL,
ENFIELD, MIDDLESEX

Manganous Sulphate as Catalyst in the Cerimetric Determination of Serum Calcium

BY V. R. WHEATLEY

ATTENTION has been recently drawn by W. R. Smith¹ to the lack of a convenient cerimetric method for the determination of serum calcium. Smith proposed heating the solution of the oxalate to 70° C. and titrating with ceric sulphate until a slight excess imparted a definite

yellow tint to the soln., a blank correction then being made. This procedure is hardly superior to the standard permanganate method and at 70° C. the use of a redox indicator would be impossible, since it would be preferentially oxidised. Katzman and Jacob² have used iodine monochloride as catalyst and ferroin as indicator, but the titration must be performed at 50° C. and the temp. carefully controlled; moreover, the end-point is poor. The discovery by G. F. Smith and Getz³ that ceric perchlorate oxidises oxalic acid quantitatively at room temp. has been applied by Reitemeier⁴ to the micro-determination of calcium. The method can be applied to blood analysis but the expense of perchloric acid and the need for frequent standardisation of the ceric perchlorate soln. prohibit its general use in routine work. Several writers have preferred to oxidise the oxalate with an excess of ceric sulphate and to determine the excess iodometrically,⁵ with standard ferrous soln., using ferroin as indicator,^{6,7} or photometrically⁸; but such indirect procedures must always be a second choice.

In view of the defects of these current procedures an attempt was made to find a suitable catalyst and the possible use of manganous salts, proposed by Szebellédy and Tanay,⁹ was investigated. For the micro-titration of oxalate these writers use a solution of oxalate in *N* sulphuric acid containing 2% of manganous sulphate or chloride, the titration being performed at 50° C., with the use of ferroin as indicator. If the concn. of sulphuric acid is increased the catalytic effect is inhibited, but it was found that by increasing the concn. of the manganous salt to 5% the titration could then be performed rapidly at room temp. The method can then be used for both the micro-determination of calcium and the standardisation of 0.01 *N* ceric sulphate. For the former the oxalate ppt. can conveniently be dissolved in *N* sulphuric acid containing the manganous sulphate catalyst, ferroin is added, and the soln. then titrated with 0.01 *N* ceric sulphate; this reagent is stable for several months and is a convenient stock soln.

REAGENTS—(1) 0.01 *N* *Ceric Sulphate*—Digest 4 to 5 g of ceric sulphate (B.D.H., low in other rare earths) with 30 ml of conc. sulphuric acid and dilute to a litre with water. Standardise as follows: Pipette 25.00 ml of 0.01 *N* sodium oxalate into a conical flask, add 25 ml of 10% manganous sulphate soln., 2.5 ml of 50% v/v sulphuric acid and 3 drops of 0.0025 *M* ferroin, and titrate with the ceric sulphate soln. After the first addition the indicator changes to blue, but in a few seconds the red colour returns and the titration can then be continued rapidly to the blue end-point. Make a blank titration with water in place of the oxalate soln.; this should be 0.2 ml or less. (2) *Acid Manganous Sulphate Solution*—Dissolve 5 g of manganous sulphate (Analar) in 100 ml of *N* sulphuric acid. (3) 0.0025 *M* *Ferroin*—This is stable for several months and can conveniently be prepared, in amounts sufficient to fill a dropping bottle, by dissolving 35 mg of ferrous sulphate and 74 mg of o-phenanthroline in 50 ml of water.

PROCEDURE—Ppt. the calcium and wash centrifugally by the usual procedure of Clark and Collip.¹⁰ Dissolve the ppt. in 2 ml of the acid manganous sulphate soln. by warming in a water-bath. Cool the solution (thorough cooling is unnecessary), add 1 drop of the ferroin indicator, and titrate with 0.01 *N* ceric sulphate. Add 1 drop of the ceric sulphate soln. first, allow the red colour to return, and continue the titration rapidly. Towards the end of the titration the red colour of the ferroin fades slightly and finally turns blue when the end-point is reached. Make a blank titration on 2 ml of the acid manganous sulphate soln. and 1 drop of ferroin soln.; this should be 0.04 ml or less.

Accuracy of the Method—Eight determinations on the same specimen of human serum gave the following results:

10.04, 10.02, 9.96, 10.04, 10.14, 10.08, 10.10, 10.12; mean 10.06 mg/100 ml. Result by permanganate 10.06 mg/100 ml.

Comparative results by this method and the permanganate method on a number of specimens of serum differed by not more than 0.1 mg/100 ml.

A 0.01 *N* soln. of ceric sulphate was standardised by the above procedure, against sodium oxalate with iodine monochloride as catalyst, using the procedure of Willard and Young,¹¹ and against Mohr's salt, using ferroin as indicator. The following are the average results of several titrations by each method. (a) against oxalate (MnSO₄ as catalyst), 0.00994 *N*; (b) against oxalate (ICl as catalyst), 0.00993 *N*; (c) against Mohr's salt, 0.00993 *N*.

SUMMARY—Manganous sulphate has been used as catalyst in the determination of blood serum calcium with ceric sulphate, with the use of ferroin as indicator. The titration can be done at room temp. and is rapid and accurate. A method is given for standardising 0.01 *N*

ceric sulphate against sodium oxalate which is more convenient than other published procedures.

REFERENCES

1. Smith, W. R., *ANALYST*, 1944, **69**, 15.
2. Katzman, E., and Jacobi, M., *J. Biol. Chem.*, 1937, **118**, 539.
3. Smith, G. F., and Getz, C. A., *Ind. Eng. Chem., Anal. Ed.*, 1938, **10**, 304.
4. Reitemeier, R. F., *Id.*, 1943, **15**, 395.
5. Rappaport, F., *Klin. Woch.*, 1933, **12**, 1774.
6. Lindner, R., and Kirk, P. L., *Mikrochem.*, 1937, **22**, 291.
7. Larson, C. E., and Greenberg, D. M., *J. Biol. Chem.*, **123**, 199.
8. Sendroy, J. (Jr.), *Proc. Soc. Exp. Biol. Med.*, 1941, **47**, 136.
9. Szebellédy, L., and Tanay, S., *Pharm. Zentr.*, 1938, **79**, 441.
10. Clark, F. P., and Collip, J. B., *J. Biol. Chem.*, 1925, **63**, 461.
11. Willard, H. H., and Young, P., *J. Amer. Chem. Soc.*, 1933, **55**, 3280.

SHRUBSALL BIOCHEMICAL LABORATORIES
WESTMINSTER HOSPITAL MEDICAL SCHOOL

May, 1944

Daily Variations in the Freezing-point Depressions of Cows' Milk

By ARNOLD R. TANKARD, F.R.I.C., AND D. J. T. BAGNALL, A.C.G.F.C., F.R.I.C.

THE variations in the freezing-point depressions given by cows' milk over a period of a few days are not only of theoretical interest but also of practical importance, since the analyst frequently calculates the extraneous water in an adulterated sample from a comparison of its f.pt. depression with that of the "appeal-to-cow" sample. So far as we are aware, very few figures of the daily variations in the f.pt. depressions of cows' milk are available, and we therefore thought that it would be of value to record the results of an investigation, made in the winter of 1935, on the milk from 6 herds of cows and from the 28 individual cows comprising those herds. As the number of cows in each herd was small (3 to 7), there was an absence of any balancing factors that might be expected to stabilise the f.pt. depressions of the milk from larger herds.

A Food and Drugs sampling officer supervised the milkings and took the samples, all of which were evening milk. The samples, numbering 24 from the herds and 112 from the individual cows, were taken daily for four days, and the results obtained are given in the following Tables.

TABLE I—DAILY VARIATIONS IN FREEZING-POINT DEPRESSIONS OF HERD SAMPLES
Freezing-point depressions °C. (Hortvet)

Herd	No. of cows	First day	Second day	Third day	Fourth day	Maximum variations		
						1 day	2 days	3 days
A	3	0.555	0.557	0.559	0.559	0.002	0.004	0.004
B	7	0.553	0.548	0.556	0.554	0.008	0.006	0.001
C	5	0.552	0.546	0.553	0.543	0.010	0.003	0.009
D	5	0.548	0.554	0.545	0.557	0.012	0.003	0.009
E	4	0.546	0.542	0.547	0.541	0.006	0.001	0.005
F	4	0.555	0.546	0.555	0.548	0.009	0.002	0.007
Average:						0.008	0.003	0.006

The minimum and maximum f.pt. depressions observed were 0.541° and 0.559° C. in the herd samples, and 0.536° and 0.564° C. in the individual cow samples, whilst the maximum variations were 0.012° C. (herds) and 0.026° C. (individual cows), and were shown by samples taken on consecutive days.

From a consideration of the whole of these results, it will be seen that the f.pt. depressions given by the herd samples, with one exception, did not vary more than 0.010° C., whilst on 80% of occasions the variations given by the individual cow samples did not exceed this figure.

During this investigation, the opportunity was taken to determine the daily variations in the fat and solids-not-fat % of the milk samples collected, and the results are set out in Table IV.

TABLE II—DAILY VARIATIONS IN FREEZING-POINT DEPRESSIONS OF INDIVIDUAL COW'S MILK SAMPLES

Herd	No. of cow	Freezing-point depressions °C. (Hortvet)						
		First day	Second day	Third day	Fourth day	Maximum variations		
						1 day	2 days	3 days
A	1	0.556	0.556	0.556	0.559	0.003	0.003	0.003
A	2	0.563	0.563	0.558	0.557	0.005	0.006	0.006
A	3	0.550	0.557	0.558	0.558	0.007	0.008	0.008
B	4	0.544	0.543	0.536	0.536	0.007	0.008	0.008
B	5	0.550	0.543	0.548	0.549	0.007	0.006	0.001
B	6	0.540	0.541	0.543	0.544	0.002	0.003	0.004
B	7	0.545	0.543	0.543	0.544	0.002	0.002	0.001
B	8	0.543	0.552	0.558	0.543	0.015	0.015	0.000
B	9	0.553	0.552	0.556	0.554	0.004	0.003	0.001
B	10	0.556	0.556	0.562	0.556	0.006	0.006	0.000
C	11	0.555	0.554	0.554	0.553	0.001	0.001	0.002
C	12	0.553	0.554	0.554	0.543	0.011	0.001	0.010
C	13	0.552	0.558	0.549	0.552	0.009	0.006	0.000
C	14	0.552	0.544	0.553	0.543	0.010	0.001	0.009
C	15	0.554	0.545	0.554	0.546	0.009	0.001	0.001
D	16	0.553	0.552	0.546	0.557	0.011	0.007	0.004
D	17	0.552	0.561	0.544	0.556	0.017	0.008	0.004
D	18	0.551	0.554	0.547	0.566	0.019	0.012	0.015
D	19	0.554	0.553	0.547	0.548	0.006	0.007	0.006
D	20	0.563	0.554	0.555	0.564	0.009	0.010	0.001
E	21	0.564	0.544	0.543	0.542	0.020	0.021	0.022
E	22	0.554	0.545	0.546	0.544	0.009	0.008	0.010
E	23	0.542	0.541	0.544	0.544	0.003	0.003	0.002
E	24	0.558	0.547	0.556	0.535	0.021	0.012	0.023
F	25	0.563	0.537	0.555	0.546	0.026	0.009	0.017
F	26	0.548	0.546	0.555	0.554	0.009	0.008	0.006
F	27	0.545	0.544	0.544	0.546	0.002	0.002	0.001
F	28	0.556	0.556	0.557	0.556	0.001	0.001	0.000
Average:						0.009	0.006	0.006

TABLE III—SHOWING THE NUMBER OF TIMES THAT THE FREEZING-POINT DEPRESSIONS VARIED BETWEEN CERTAIN LIMITS

Variations in freezing-point depressions °C. (Hortvet)	Herds			Individual cows		
	1 day	2 days	3 days	1 day	2 days	3 days
0.000-0.005	7	10	3*	27	33	15
0.006-0.010	10	2	3	33	18	9
0.011-0.015	1	—	—	9	4	1
0.016-0.020	—	—	—	9	—	1
0.021-0.025	—	—	—	3	1	2
0.026-0.030	—	—	—	3	—	—
Percentage of variations < 0.011	94	100	100	71	91	85

TABLE IV—SHOWING THE NUMBER OF TIMES THAT THE FAT AND S.N.F. OF THE SAMPLES VARIED BETWEEN CERTAIN LIMITS

Variation %	Herds						Individual cows					
	Fat			S.N.F.			Fat			S.N.F.		
	1 day	2 days	3 days	1 day	2 days	3 days	1 day	2 days	3 days	1 day	2 days	3 days
0.00-0.20	9	7	6	16	9	4	41	25	13	69	45	24
0.21-0.40	4	3	0	2	3	2	18	11	9	10	9	3
0.41-0.60	1	—	—	—	—	—	11	1	5	4	2	1
0.61-0.80	—	—	—	—	—	—	6	4	—	1	—	—
0.81-1.00	1*	1*	—	—	—	—	2	1	1	—	—	—
1.01-1.50	3*	1*	—	—	—	—	1	3	—	—	—	—
1.61-2.10	—	—	—	—	—	—	5	1	—	—	—	—
Percentage of variations < 0.41	72	83	100	100	100	100	70	64	79	94	98	96

* Due to samples from 2 herds of 3 and 4 cows.

SUMMARY—The variations in the f.p.t. depressions given by 24 samples of the evening milk, taken over periods up to 3 days, from herds of 3 to 7 cows were, with one exception, not greater than 0.010° C., whilst the variations in the fat and solids-not-fat were usually not greater than 0.4%. The max. variation over 3 days in the f.p.t. depressions of the milk from an individual cow was 0.026° C.

Our thanks are due to Mr. C. P. G. Clayton, F.S.I.A., for carrying out the sampling, and to Mr. A. H. Coombes, B.Sc., F.R.I.C., for the laboratory work.

REFERENCE

Bagnall, H. H., ANALYST, 1937, 62, 34.

THE CITY LABORATORIES
184, HIGH STREET, HULL

April, 1944

Notes

THE ANALYSIS OF VULCANISED RUBBER, WITH SPECIAL REFERENCE
TO SYNTHETIC MATERIALS

THE chemistry of vulcanised rubber testing has always been largely empirical because of the failure to find a satisfactory method for the direct estimation of rubber hydrocarbons. Attempts have been made to isolate the rubber by successive removal of the other ingredients by extraction processes, while other suggested methods¹ involve the preparation of derivatives, such as the tetrabromide and the nitrosite. Unfortunately these comparatively early proposals did not yield reliable results, and it has become the established practice² to calculate the content of rubber hydrocarbon (R) from the formula:

$$R = 1.03 [100 - (A + C + K + F + X)],$$

in which A represents the acetone extract, C chloroform extract, K alcoholic potash extract, F "fillers" (mineral matter, carbon black, etc.), X sulphur in combination with rubber hydrocarbon, and 1.03 is a factor to allow for the acetone extract of raw rubber (due to the natural resin content). The empiricism of this procedure is at once evident when it is pointed out that the percent. of extracts obtained depend upon the duration of the extractions (see *e.g.*, Wyatt³).

This calculation was satisfactory when applied to products manufactured from natural rubber, in spite of the complications introduced by the use of vulcanisation accelerators, antioxidants, organic fillers, colouring matters, etc. But the analysis of modern commercial compounded rubbers, or "elastomers," is much more difficult. Natural rubber, like other polymers of high molecular weight, can scarcely be said to consist of numbers of identical molecules, but contains units built up from many isoprene molecules; the union of the isoprene molecules in different ways and to form chains of different lengths may be held to account for the varying physical properties of rubber samples, but the chemistry is essentially determined by the isoprene foundation and the resulting unsaturation of the polymer:

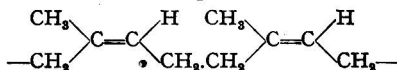

(The theoretical iodine value for this structure is 372.8; experimental values range from 348 to 357, mean about 351⁴.) Passing to the synthetic rubbers, one finds associated with the changed monomer a change in chemical properties. One could scarcely expect such widely different substances to be amenable to the original solvent treatment, and examination of the action of acetone immediately reveals the breakdown of the analytical scheme outlined above. It has been mentioned that the acetone extract of natural rubber is about 3%, for Buna-S and -SS it is about 7%, while Thiokol-RD is soluble. Possibly a new method of analysis could be worked out depending, as does the established method, upon extraction with various solvents but the necessary data for the selection of the appropriate solvents are not available in the literature. The technologists' interest in the action of solvents is best met by the publication of their swelling (or disintegrating) effects rather than the % of the material extracted. That the two properties are not necessarily parallel may be seen from the comparatively great swelling of natural rubber caused by chloroform, yet the chloroform extract is only *ca.* 3%.⁵

Even if such a scheme of analysis were established, there would remain the problem of identifying the elastomers. It is true that certain indications might be obtained from a preliminary examination; for example, polyisobutylene may be loaded with *ca.* 1000% of fillers without losing its elasticity.⁴ Some materials might be recognised by their odours (Buna-S smells of styrene, Thioplasts and early Neoprene have characteristic odours, etc.), but the substance so recognised may be present merely as a modifying agent; moreover, the modern trend is towards the elimination of such odours. Valuable clues may, however, be obtained from the odour liberated on heating (ester-like compounds from polyacrylic esters, HCl from polyvinylchlorides, H₂S from Perduren, etc.), and Nechamkin⁶ has described the recognition of synthetic plastics in general from their behaviour on burning. More satisfactory indications of a chemical nature depend upon the nitrogen content (*ca.* 7%) of Perbunan, the sulphur (*ca.* 83%) of Thiokol, the chlorine (*ca.* 40%) of Neoprene, and the saturated character of polyisobutylene in contrast with the unsaturation of natural rubber. However, it appears that the absolute identification of the ingredients of a compounded elastomer would involve degradation and tedious examination of the products; it would then still be doubtful whether one was dealing with a mixture of polymers or a product of co-polymerisation. One therefore turns to physical methods as being possibly more promising for routine testing. Tables have been published⁷ showing the sp.gr. and ref. index of the various raw products, but these values would

obviously be modified by the compounding and would be applicable only if the original materials could be isolated. Identification of certain elastomers is possible by observing the nature of the fluorescence in ultra-violet light, and it has recently been claimed⁶ that the infra-red absorption spectrum not only permits recognition of the elastomer present, but can also be applied to its determination in a mixture.* The majority of the elastomers also give a characteristic period in X-ray analyses,⁹ the elastomer being held in a state of tension; it may prove possible to distinguish by this method between co-polymers and mixtures of single polymers.

Consideration in the above manner shows the complexity of the problem of establishing a scheme of chemical or physical analysis of elastomers which would be suitable for routine application to samples of unknown constitution. Moreover, it must be remembered that relatively small changes in manufacturing technique may lead to large differences in the behaviour of the product, which may not be reflected in its chemical composition. For example, the properties of Buna-S are dependent upon the degradation undergone at one stage of its preparation; ethyl cellulose of given ethoxyl content is available in different viscosities, etc. (These instances are examples of the dependence of properties upon the molecular weight.) For routine purposes, analysis is thus forced to leave the field to performance tests, such as the determination of tensile strength, elongation at break rigidity, permanent set, abrasion and flexing resistance, etc. Much research will be necessary before this state of affairs can be altered.

The value of a specification couched in chemical terms may be doubted, in view of the above arguments, and such a specification may be rendered useless if care is not taken over details. For example, it is convenient for the manufacturer to measure his materials by volume, and there is a corresponding tendency to draw up specifications in terms of volume instead of by weight. The result is that while the volume of rubber present in a compound may be calculated on the assumption of an average specific gravity of 0.91-0.92 for raw rubber, this will be the true volume, whereas the manufacturer will measure his materials in bulk. The apparent density of the raw rubber used will, of course, depend upon its physical condition (smoked sheet, spray-dried, etc.) and it is, therefore, impossible to determine in border-line cases if the specification has been observed.

REFERENCES

1. See, e.g., Memmler, K., "Science of Rubber," transl. Dunbrook and Morris, New York, 1934.
2. British Standard Specification No. 903/1940, *Testing of Vulcanised Rubber*.
3. Wyatt, G. H., *ANALYST*, 1941, **66**, 362.
4. Barron, H., "Modern Synthetic Rubbers," London, 1943.
5. Dawson, T. R., and Porritt, B. B., "Rubber, Physical and Chemical Properties," Research Association of British Rubber Manufacturers, 1935.
6. Nechamkin, H., *Ind. Eng. Chem., Anal. Ed.*, 1943, **15**, 40.
7. See, e.g., Simmonds, H. R., Ellis, C., and Bigelow, M. H., *Handbook of Plastics*, London, 1943.
8. Barnes, R. B., Williams, v. Z., Davis, A. R., and Giesecke, P., *Ind. Eng. Chem., Anal. Ed.*, 1944, **16**, 9.
9. See, e.g., Burk, R. E., and Grummitt, O., "Chemistry of Large Molecules," New York, 1943.

L.M. & S. RAILWAY CO., RESEARCH DEPARTMENT
CHEMICAL LABORATORY, STONEBRIDGE PARK, MIDDLESEX

G. H. WYATT
May, 1944

A VACUUM-OPERATED MICRO-STIRRER

In any titration process adequate mixing is essential. Swirling, although easy on the macro-scale, is not readily applied to micro-titrations. For that purpose a stream of gas bubbles is frequently employed.¹ Where volatile substances are involved (e.g., bromine, ammonia), or where the solution has a tendency to foam, agitation by other means may have advantages.

Schwarz² has described a device whereby vibrations produced by feeding a radio loud-speaker unit from the A.C. mains are transmitted directly to the titration vessel. On attempting to use this simple method we found that the amplitude of the vibrations was insufficient to have appreciable effect. Accordingly, we constructed a more powerful apparatus operating on this principle. But, although the surface of the test soln. was in vigorous motion, very little stirring effect could be observed in the bulk of the liquid.

For agitation of more usual type, mixing without splashing is best effected if the stirrer-blade in its motion does not rise above the surface of the liquid. In micro-titrations the depth of the liquid is often limited; hence the travel of the stirrer needs to be small.

Although the vacuum-operated stirrer described by Botham and developed by Davidson is very useful in its own sphere, we had great difficulty in modifying it to produce very small strokes. Accordingly the device described below was developed.

Container A (Fig. 1) is made from heavy glass tubing and is partly filled with mercury. A cylindrical float B with thickened ends slides easily within the central tube and rests on the surface of the mercury. The valve rod C normally rests on the surface of the seating of sleeve D, but can be lifted clear by the rising of the float. The interchangeable stirrer-heads E, E₁, E₂, etc., slip into the upper end of the valve rod. The stirrer-heads (Fig. 2) are made by drawing down glass rod to about 1 mm diameter and suitably bending. Suction tube F is connected by way of a safety bottle to a water-pump.

Motion of the stirrer is provided by the oscillation of the mercury about its mean level, the oscillation being maintained by automatic build-up and break of vacuum. A feature is the unhampered movement of the mercury and float over a considerable portion of the stroke, permitting the acquisition of considerable momentum which is used to operate the stirrer and valve-gear. When the lower end of the valve rod is struck by the float it is raised, and ingress of air *via* the valve and port G rapidly destroys the vacuum; hence the driving force. When the momentum of the moving parts is expended they fall by gravity,

* It is also claimed in this paper that the phosphorus content of a sample reveals the presence or absence of natural rubber.

closing the valve and causing the cycle of operations to be repeated. The "impact" principle permits small, uniform, powerful strokes to be obtained and prevents sticking of the valve. The device is self-starting.

Proportions indicated in Fig. 1 were found to be convenient, although dimensions can be varied considerably. With the use of 10-15 ml of mercury a speed of 3-4 strokes per sec. was obtained. Steady strokes, as small as 1 mm, can be obtained by reducing the clearance x when at rest to a few mm and using gentle suction. The clearance is readily adjustable by sliding the sleeve within the rubber stopper. Table I summarises the behaviour observed when 10 ml of mercury are used, and indicates that there is little advantage in increasing x beyond 10 mm.

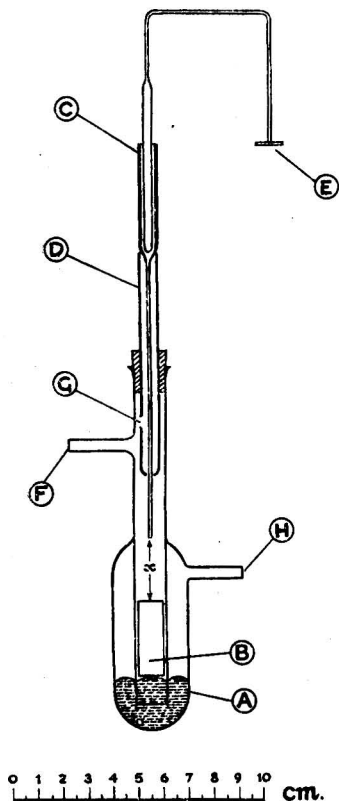

Fig. 1

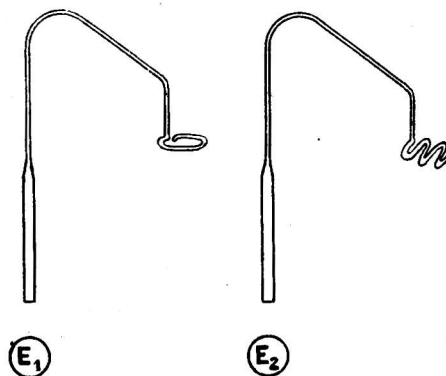

Fig. 2

The rate of stirring may be considerably increased by introducing a partial obstruction between the stirring-device and the safety bottle. A further increase occurs if the vent tube H is closed. Table II illustrates the effect of these modifications. The obstruction was a 30-cm length of 1-mm bore tubing; 15 ml of mercury were used, while x was set at 10 mm.

Several of these stirrers have been run for periods of up to 8 hr. without any sign of failure. The rapid even strokes ensure efficient mixing with no splashing. The fineness and flexibility of the stirrer heads prevents damage to the tip of the micro-burette should contact accidentally occur.

TABLE I. PUMP SPEEDS

Clearance mm	Low		Medium		Fast	
	Stroke mm	Cycles /sec.	Stroke mm	Cycles /sec.	Stroke mm	Cycles /sec.
4	1	4.6	3	4.8	5.5	5.2
9	4	3.6	7	3.8	8.0	5.0
17	3	3.4	7	4.0	10.5	4.5
26	4	3.6	7	4.0	11.0	4.4

TABLE II. PUMP SPEEDS

Mode of Operation	Low		Medium		Fast	
	Stroke mm	Cycles /sec.	Stroke mm	Cycles /sec.	Stroke mm	Cycles /sec.
(a) Normal	4	3.8	9.5	3.6	14	3.6
(b) Obstruction	3	5.5	11	5.3	13	5.4
(c) As (b), vent tube closed	2	7.0	11	6.0	12.5	5.9

REFERENCES

1. Wyatt, G. H., *Analyst*, 1944, **69**, 88.
2. Schwarz, K., *Mikrochem.*, 1935, **18**, 106.
3. Botham, G. H., *Chem. and Ind.*, 1942, **61**, 10.
4. Davidson, V. E., *J. Inst. Chem.*, 1942, 202.

SOUTH LONDON CENTRAL PUBLIC LABORATORY
LONDON, S.E.11

M. A. FILL
J. T. STOCK
May, 1944

Home Office

PROVISIONAL AND STATUTORY RULES AND ORDERS*

1944—No. 283. **The Poisons (Amendment) Rules, 1944, dated February 21, 1944, made by the Secretary of State under Section 23 of the Pharmacy and Poisons Act, 1933 (23 & 24 Geo. 5, c. 25), as amended by Regulation 60 HA of the Defence (General) Regulations, 1939.** Price 1d.

These Rules amend the Poisons Rules, 1935 to 1942, by adding a paragraph (2) at the end of Rule 6 and by adding a Fifteenth Schedule. The effect of these amendments is to exempt agricultural and horticultural insecticides consisting of nicotine dusts containing not more than 4% of nicotine from certain provisions of Sec. 18 (2) of the Act.

These Rules, which came into force forthwith, may be cited as the Poisons (Amendment) Rules, 1944, and the Poisons Rules, 1935 to 1942, together with these Rules may be cited as the Poisons Rules, 1935 to 1944.

Ministry of Food

STATUTORY RULES AND ORDERS

1944—No. 398. **Order, dated April 4, 1944, amending the Nuts (Control and Maximum Prices) Order, 1942.** Price 1d.

The maximum price of several varieties is changed. As the maximum price now prescribed for hand-picked selected peanuts differs from that for other qualities of peanuts, the mixing of peanuts of different qualities is prohibited.

It is provided that certificates of a Public Analyst or the Government Chemist shall be sufficient evidence of the matters they certify, unless challenged.

— No. 553. **Order, dated May 9, 1944, amending the Feeding Stuffs (Regulation of Manufacture) Order, 1943.** Price 2d.

This Order, which comes into force on May 22, 1944, alters the composition of permitted compounds by increasing the quantity of home-grown grains and reducing the quantity of low protein oilseed cake. The Order also removes the requirement to include a minimum of 1% of cod-liver oil in National Pig Food No. 1.

STANDARD FOR SHREDDED SUET: PRÉCIS OF REPORT RECEIVED FROM THE INTER-DEPARTMENTAL COMMITTEE ON FOOD STANDARDS

1. The Committee was informed that the manufacture of shredded suet from imported premier jus is subject to control by licence and that it is a condition of the licences that the product shall contain not less than 83% of fat. This figure was adopted in 1931 by the Council of the Society of Public Analysts and Other Analytical Chemists pending the establishment of a legal standard.

2. In the manufacture of shredded suet from premier jus the fat is forced into shreds or granules and a cereal or amylaceous filler is added so as to form a coating over the particles of fat, thus preventing them from adhering together and at the same time retarding the development of rancidity.

3. The amount of filler taken up by the shredded fat depends primarily on its stickiness, which in turn depends on the temperature at which the manufacturing process is conducted. Manufacturers must give special attention to the problem of securing uniformity of distribution, otherwise part of a batch will take up more than its share of the amount of filler allowed by the manufacturing formula. In spite of all practicable care, complete uniformity cannot be ensured and some tolerance is therefore necessary to allow for unavoidable variations.

4. The proportion of filler used in the past by different manufacturers has varied considerably. A purchaser of shredded suet is primarily purchasing fat and it is desirable that the fat content shall be the maximum that can be included whilst still retaining good keeping properties. The Committee is of the opinion that shredded suet, to be of satisfactory quality, should not contain substantially less than 85% of fat, and that a product approximating to this standard will have the necessary keeping properties. The Committee is satisfied that the allowance of 2% for uneven distribution on and among the shreds, which was adopted by the Council of the Society of Public Analysts in 1931, is reasonable, and understands that it is considered adequate by the manufacturers of shredded suet.

5. A small amount of suet (*i.e.*, natural unrendered fat), received by butchers as part of their meat allocation, is chopped or minced, and in the latter case mixed with cereal filler, and sold under the description

* Obtainable from H.M. Stationery Office. Italics signify changed wording.

"shredded suet." By whichever method it is prepared it differs from the shredded suet made from premier jus by reason of the presence of membrane and moisture. If made by chopping it will contain more fat than the product made from premier jus, but if made by mincing and admixture with a filler it is likely to contain less owing to the membrane and moisture in the raw material and the impracticability of analytical control.

6. It was suggested to the Committee that the use of the description shredded suet for the products made by butchers was misleading and that the name should be restricted to the product made from premier jus. The Committee is however of the opinion that the general public would be equally satisfied whether the product supplied in response to a demand for shredded suet had been prepared with premier jus or suet. Further, it is considered that a purchaser of shredded suet is not prejudiced if he receives a product containing membrane and moisture provided he also receives the appropriate amount of fat. It therefore does not appear to the Committee that there is any necessity, from the viewpoint of protecting the public in regard to quality, for recommending the imposition of this restriction.

7. The Committee noted that the statement issued by the Council of the Society of Public Analysts included an expression of opinion that "the nature of any admixture to suet should be declared." This recommendation is, however, outside the terms of reference of the Committee and no comment is therefore made thereon.

8. The Committee accordingly recommends that shredded suet should be required to contain not less than 83% of fat.

March, 1944

Legal Notes

The Editor would be glad to receive particulars of cases with points of special legal or chemical interest

WHAT IS "CHLORODYNE"? LABEL CALCULATED TO MISLEAD

ON April 29th a Liverpool wholesale firm was charged at Beaumaris Police Court with selling a mixture called Chlorodyne bearing a label calculated to mislead contrary to Sec. 6 of the Food and Drugs Act, 1938, and with the publication of an advertisement, a label, referring to that mixture in terms which were calculated to lead to the use of that article for the treatment of human beings for tuberculosis, contrary to Sec. 8 of the Pharmacy and Medicines Act, 1941.

For the prosecution Mr. H. A. Thomas stated that a sample of Chlorodyne, Non-Poisonous, was purchased from a retailer in Llangord, Anglesey. The labels applied to the bottles stated: "In Coughs, Colds, Influenza, Ague, etc., 5 to 10 drops. In Consumption, Asthma, Bronchitis, Spasms, Sea-sickness, 10 to 25 drops."

The certificate of the Public Analyst (Mr. Harold Lowe) stated that the article was not to be considered genuine, as it contained no morphine hydrochloride or hydrocyanic acid.

In support of this opinion, Mr. Thomas quoted extracts from the B.P. Codex, 1934 (which stated that Chlorodyne was a synonym of Tincture of Chloroform and Morphia), the National Formulary for National Insurance Purposes, the Drug Tariff issued by the Ministry of Health, The Dictionary of Synonyms included in the Pharmaceutical Pocket Book, and the "Extra Pharmacopoeia." The word "Non-Poisonous" in the label did not mean that all the poisonous substances were left out. Chloroform was included but it was under 10%. Hydrocyanic acid and morphine hydrochloride could have been included, provided that they were in sufficiently small quantities, without the need to mark the substance "Poison." With regard to the reference to tuberculosis, the word consumption was the everyday word for pulmonary tuberculosis.

It was true that proprietary brands of Chlorodyne were on the market, but all contained morphine or some other alkaloid of opium. These substances were not called merely "Chlorodyne" but "Collis Browne's Chlorodyne" or "Freeman's Chlorodyne." Mr. Lowe, giving evidence in support of his certificate, said that this substance would not have therapeutic qualities similar to those of Chlorodyne as known to the medical and pharmaceutical professions.

Dr. Arnold Davies, M.D., D.P.H., County Medical Officer of Health, said that the substance could not properly be called Chlorodyne. It did not contain the essential ingredients and did not have the same therapeutic properties. It would have no effect on tuberculosis.

Mr. W. L. Thomas, M.P.S., said that, if asked for Chlorodyne he would supply Chlorodyne B.P.C., 1934. He would only give a proprietary brand if he were specifically asked for that brand.

Dr. J. Glyn Jones, M.D., Tuberculosis Physician to King Edward VII, Welsh National Memorial Association, said that it would be a menace to the health of the nation if people were permitted to believe that the substance was a cure for consumption. The evils of self-treatment of this disease, with the possibility of infecting others, could not be over-emphasised. The witness drew attention to the dosages stated on the label: "Coughs, 5 to 10 drops; Consumption, 15 to 20 drops." A cough was a symptom of tuberculosis and the increased dosages for consumption implied that this substance would do more than relieve the cough. If sufferers relied on this stuff they would probably come for efficient treatment only when it was too late and when other members of the family had become infected. As much as £400,000 a year was spent for the treatment of this disease, and if these advertisements were allowed to go unchecked this money and the work of a great many specialists would be wasted.

Mr. Gordon Roberts, for the defence, said that the firm had obtained the Chlorodyne from another firm and their dealings in it were very small. They had been obeying the Government's Order in using old labels. The label did not claim a cure for consumption. He submitted that Chlorodyne had become a generic term applied to many different formulae. Nobody could say definitely what Chlorodyne should contain.

The Bench held that the cases had been proved and fined the company £10 in respect of each offence, with £9 13s. 5d. costs.

The British Pharmacopoeia, 1932

We have been asked to insert the following notices:

THE SCHEDULE—OINTMENTS (see 6th Addendum to the British Pharmacopoeia, 1932, p. IV. Notice concerning Ointments):

The period during which ointments prepared according to the original formulae of the British Pharmacopoeia, 1932, or Addenda, may be dispensed or supplied is extended until further notice.

THE SCHEDULE—OLEUM HIPPOGLOSSI (HALIBUT LIVER OIL). (See 4th Addendum to the British Pharmacopoeia, 1932, p. 23.) The requirement for *iodine value of glycerides* is changed from "112 to 130" to "112 to 150."

ABSTRACTS OF PAPERS PUBLISHED IN OTHER JOURNALS

Food and Drugs

Detection of Decomposition in Liquid, Frozen and Dried Eggs. H. A. Lepper, M. T. Bartram and F. Hillig (*J. Assoc. Off. Agr. Chem.*, 1944, 27, 204-223)—Of the chemical determinations made on samples of liquid, frozen and dried eggs of known origin, the methods for volatile acids and lactic acid were found extremely useful as indications of the extent of decomposition. To prepare liquid or frozen egg for determination of lactic acid, shake 20 g with 30 ml of water, add 10 ml of *N* sulphuric acid and 15 ml of 20% phosphotungstic acid, make up to 125 g with water, shake for 1 min. and filter (50 ml of the filtrate will weigh 50 g). With dried egg, mix 5 g with 50 ml of water, add 10 ml of sulphuric acid and 12 ml of phosphotungstic acid and proceed as before. The method of determination is that of Hillig (*J. Assoc. Off. Agr. Chem.*, 1937, 20, 130; ANALYST, 1937, 62, 614) except that standard barium lactate soln. is used instead of lithium lactate. To prepare this soln., dissolve in ca. 10 ml of water the amount of pure lithium, zinc or calcium lactate equiv. to ca. 300 mg of lactic acid. Transfer the soln. to an extractor (*J. Assoc. Off. Agr. Chem.*, 1942, 25, 256), add 0.5 ml of sulphuric acid (1+1) and adjust the vol. to 50 ml. Extract with ether for 2 hr., add ca. 20 ml of water to the contents of the extraction flask, remove the ether on the steam-bath and neutralise the aqueous residue with 0.1 *N* barium hydroxide. Transfer the neutralised liquid to a 200-ml flask, make up to the mark and shake. Dilute such a vol. of this soln. as will contain the equiv. of 250 mg of lactic acid to 500 ml. Each ml of this soln. \equiv 0.5 mg of lactic acid. A 5-fold dilution of this soln. is used to establish the lower portion of the standard calibration curve. The method is then as described (*loc. cit.*). The method for determination of volatile acids (formic acid and acetic acid) is essentially that of Hillig (*J. Assoc. Off. Agr. Chem.*, 1938, 21, 688; ANALYST, 1939, 64, 44) with certain refinements, for details of which the original paper should be consulted. Bacteriological examination of these products included counts of viable bacteria, microscopical counts of total bacteria and determination of members of the coliform group. The viable and coliform bacteria were determined by the methods of the A.O.A.C., nutrient agar plates being counted after incubation for 72 hr. at 32° C. The microscopical count was made by the method of the Amer. Public Health Assoc. ("*Standard Methods for Examination of Dairy Products*," 1941, p. 202) modified for dried eggs by the use of a 2 sq. cm. area and for liquid and frozen eggs by spreading 0.01 ml of the undiluted material over areas of 1 and 2 sq. cm. respectively. Determinations of the coliform group, although a good index of insanitation, have only a limited value as evidence

of decomposition, and many of these organisms are destroyed in the drying process. With frozen eggs a rough proportionality exists between the coliform index and the plate count. Viable organism counts in liquid eggs and in frozen eggs made from them are generally of the same magnitude, and, although some variations occur with freezing, the count as a rule depends upon the quality of the product. With dried eggs the plate count increases as decomposition proceeds, but the increase is not a reliable index of the original condition of the liquid eggs. The microscopical count of both living and dead cells appears to be as reliable an index of decomposition of liquid and frozen eggs as is the plate count, and with dried eggs it is much more reliable. An important advantage of the microscopical count is that it shows no appreciable change with storage for 2 years at room or refrigeration temp. (40° F.). From all the data found the following criteria for some forms of decomposition in liquid, frozen and dried eggs were established—With liquid and frozen eggs a microscopical count of over 5,000,000 per g, with determinable amounts of either formic or acetic or lactic acid in excess of 7 mg per 100 g, shows the presence of decomposed eggs. With dried eggs a count of over 100,000,000 per g, with formic and acetic acids over 65 mg and lactic acid over 50 mg per 100 g (dry basis), shows the presence of decomposed eggs. Whenever the taste of dried egg (determined by stirring 10 g with 30 ml of water in a tube immersed in boiling water and tasting the scrambled product) was sour, the bacteriological and chemical results have been above these maximum values. Certain types of decomposition are not indicated by these criteria, but in absence of other criteria reliance may be placed on the odour. A. O. J.

Persistence of Monochloroacetic Acid in Fruit Juices and Carbonated Beverages. J. B. Wilson (*J. Assoc. Off. Agr. Chem.*, 1944, 27, 195-200)—Expts. were made to examine the statement that monochloroacetic acid added to fruit juices and carbonated beverages is hydrolysed and disappears within a short time. The following method was used to determine monochloroacetic acid in products containing 5 to 150 mg in 150 ml.—The reagents are silver nitrate soln. (9 g per litre \equiv 5 mg of monochloroacetic acid per ml), ammonium thiocyanate soln. of equiv. strength (4.03 g per litre, standardised against pure sodium chloride) and sat. ferric alum soln. In the outer part of a continuous extractor ("*Methods of Analysis*," A.O.A.C., 1940, 594, Fig. 57B) place an amount of the product, not more than 150 ml, containing 5-100 mg of monochloroacetic acid. Dilute if necessary to 150 ml and extract with ether for 2-3 hr. Drain as much as possible of the ether into the extraction flask, add 25 ml of *N* sodium

hydroxide in excess of that required to make the aqueous layer alkaline to litmus paper and remove the ether on the steam-bath in a current of air. Digest on the steam-bath for 2 hr. or heat under reflux for 30 min. Add 50 ml of water, 15 ml of nitric acid and a known vol. of the silver nitrate soln. in excess. Shake for 1 min., add the ferric alum indicator and titrate the excess of silver nitrate with the standard ammonium thiocyanate soln. In the same way titrate a portion of the silver nitrate soln. equal to that added to the sample. The difference between the titrations indicates the amount of monochloroacetic acid present. With products containing 1–10 mg of monochloroacetic acid in 150 ml, dilute the silver nitrate and ammonium thiocyanate solns. 5-fold, restandardising the latter soln. against a correspondingly diluted sodium chloride soln. Extract and hydrolyse the sample as previously described, add 50 ml of water, 15–20 ml of nitric acid and 1 ml of ferric indicator. At the same time prepare a blank containing 75 ml of water, 15 ml of nitric acid and 1 ml of ferric indicator. To each add 5 ml of dil. silver nitrate soln. and mix thoroughly. To the blank soln. add 4 ml of the dil. thiocyanate soln. and to the sample soln. add gradually small amounts of the same soln. until the pink colour fades slowly on mixing. Shake both solns. and filter, rinsing flasks and filters with *ca.* 50 ml of water. Complete the titrations of the filtrates, matching the colour of the sample soln. against that of the blank. Each ml difference in titration = 1 mg of monochloroacetic acid. These methods were applied to the determination of known amounts of monochloroacetic acid added to carbonated Creme Soda and Orange beverages prepared in imitation of commercial products. Similar expts. were made with pasteurised and unpasteurised bottled apple juice, with canned orange juice and with canned citrus juice. The samples were stored at room temp. without protection from sunlight or from summer heat, the fruit-type and non-fruit-type carbonated beverages for 19 months, the apple juice for 13 months, and the orange juice and grapefruit juice for 30 months. Analyses at intervals and at the end of these periods showed that little, if any, loss of monochloroacetic acid occurred.

A. O. J.

Conditions for Complete Acid Inversion in Analysis of Final Cane Molasses. F. W. Zerber, J. E. Mull and J. Martin (*J. Assoc. Off. Agr. Chem.*, 1944, 27, 139–145)—The investigation was undertaken to ascertain the conditions under which an average blackstrap molasses is completely inverted. Since those molasses vary widely in composition, the conditions may be expected to vary from sample to sample, and the problem is further complicated by the presence of reversion products that are hydrolysed by the acid. The simplest way to determine the proper conditions for complete inversion is to use as criterion the max. *l*-rotation (min. *d*-rotation). When the *l*-rotation is plotted against the time of inversion at any given temp. of inversion, the curve gradually rises to a max. value as inversion proceeds and then descends as invert sugar is destroyed. Until the correct Clerget divisors for blackstrap molasses have been determined the divisors established for sucrose may be used to obtain figures for sucrose content. In the invertase method it has been shown that the divisor found for pure sucrose is correct for impure products also. Jackson and Gillis give for pure sucrose determined by Method IV (*Bur. Standards Sci. Paper*, 1920, 375) the basic

divisor 132.63 independently of the temp. of inversion up to 60° C., and they conclude that no invert sugar is destroyed. Jackson and McDonald found later that the basic divisor decreases with increase in the temp. of inversion from 132.66 at room temp. to 132.56 at 60° C., this difference having little practical significance. Samples of Cuban and Puerto Rican final molasses were inverted for 8, 10 and 12 min. at both 60° C. and 70° C. and, for comparison at 28° C. for 24 hr. In each analysis half-normal wt. solns. of the molasses were used and the readings were made with quarter normal wt. solns. at 20° C. The max. average invert reading was established after inverting for 24 hr. at 28° C. Almost the same reading was obtained by inverting at 70° C. for 8, 10 or 12 min., and it was clearly shown that inversion for 10 min. at 60° C. is not sufficient. Average sucrose figures were calculated by the basic divisors of Jackson and Gillis and also by those of Jackson and McDonald, valid in each instance for Method IV (*loc. cit.*) at the temp. of inversion. The new concn. factor of Jackson and McDonald, *viz.*, 0.0794, was used to correct the basic divisor to the concn. of solids in the quarter-normal soln. No more inversion occurred when inversion at 28° C. for 24 hr. was prolonged for another 5 hr. Inversion at 60° C. was not complete even in 12 min., but in 14–16 min. the sucrose figures exceeded those obtained by inversion at 28° C. by *ca.* 0.1%. In 25 min. slight destruction of invert sugar had occurred. The top of the inversion curve is thus somewhat flat. With impure products the entire process including the destruction of invert sugar proceeds more slowly than with pure sucrose at the same temp. and Zerber (*J. Assoc. Off. Agr. Chem.*, 1931, 14, 172) has shown that asparagine and aspartic acid occurring in molasses retard the destruction of laevulose by hydrochloric acid. A temp. of 35° C. was found to be too high for 24 hr. inversion. Inversion at 60° C. for 20 min. gave results for sucrose 0.04–0.08% lower than those obtained by inversion at 28° for 24 hr., whereas in a previous expt. the result was higher. Apparently in the long run results obtained by these two procedures would agree within ±0.1%. The following conclusions may be drawn—The average blackstrap molasses is completely inverted in 24 hr. at 28° C.; heating to 60° C. for 10 min. does not give complete inversion and the time must be extended to 15–20 min.; heating at 70° C. for 8 min. gives a sucrose figure agreeing with that obtained by inversion at 28° C. for 24 hr. These conclusions are valid only for average Cuban or Puerto Rican blackstrap molasses.

A. O. J.

Moisture in Potato Starch. W. L. Porter and C. O. Willits (*J. Assoc. Off. Agr. Chem.*, 1944, 27, 179–194)—Two types of mechanical convection oven were used, *viz.*, a Brabender moisture tester and a Precision floor model. The Brabender moisture tester, an air oven with forced circulation, has a balance incorporated in such a manner that the sample can be weighed without removing it from the oven. The oven was regulated to different temperatures and the loss in wt. was noted at definite time intervals until constant. In the Precision floor-model mechanical convection oven several samples for each particular drying temp. were placed in the oven, one being removed after each time interval so that repeated heating and re-cooling was avoided. A similar procedure was adopted with a Precision table-model gravity convection oven. Carter-Simon tests were made

with a number of samples weighed at the same time but passed through the oven at different rates so that the time of drying was varied. Tests in a Weber vacuum oven (<5 mm of mercury) were made in the same manner as with the mechanical convection oven. The loss of wt. of potato starch recorded by the Brabender moisture tester becomes greater with successively higher temp., the rate of loss at each temp. being higher at the beginning and falling off rapidly until the wt. is constant. The curves show that the total loss of volatile matter is dependent upon the temp. At a high drying temp. a light brown discoloration appears in the time necessary to establish constancy of wt. This alteration does not affect the wt., and determinations of the spectral reflectance and estimations of the colour given with iodine by aqueous extracts showed respectively that no change in composition and solubility occurred before the constant wt. period, and that with drying at 180° C. appreciable decomposition, indicated by further loss in wt. and formation of erythrodestrins, occurred only when heating was continued for 4 hr. after the attaining of constant wt. Any method for the determination of moisture based on the steep portion of the isothermal curves showing the relation between loss of wt. (ordinate) and time (abscissa) is subject to considerable error produced by relatively small time differences. This may account for the inconclusive data reported in the literature for moisture content of potato starch, since most of the standard methods specify conditions represented by points on the steep portions of the curves. A more closely reproducible method would consist in the use of a temp. indicated on the flattest portion of the curve and a time long enough to ensure constancy of wt. With the Brabender moisture tester the method would involve heating at 135°-145° C. for 30-60 min. or to const. wt., and now that this basic method has been established it should be possible to employ any other method that will duplicate these moisture values within the limit of error of the specific procedure. With potato starch dried in a gravity convection oven at 100° C. for 24 hr. the loss in wt. never quite reached the value obtained in the mechanical convection oven at 100° C., nor was the drying so rapid. In neither form of oven did the loss reach that established by the basic method. Vacuum drying at 5 mm of mercury at 80° C. gave a value in close agreement with that of the basic method, constant wt. being reached in 22-24 hr. Vacuum drying at 100° C. gave a slightly higher value with constancy in 5 hr. Drying at 100° C. by any of the other methods gave lower values. At 135° C. the air drying methods used, with the exception of the Carter-Simon method, gave results comparable with those of the basic method. At higher temp. (150° C.) slight decomposition occurred. Quick approximations can be made, however, by heating at such a temp. for a time that will give a loss of wt. comparable with that of the basic method (e.g., the Carter-Simon moisture test, which is operated at 155° C. for 15 min.), but heating must be stopped at the end of the specific time. Distillation methods gave results of the same order as those of the oven methods, and generally as the temp. of distillation was raised the amount of water obtained increased. The lower-boiling liquids (carbon tetrachloride and toluene) gave low results; xylene and tetrachloroethane gave results agreeing with those of the basic method, tetrachloroethane having the advantage that the starch floated on the top. The Karl Fischer chemical method for determination of

moisture gave low results with potato starch. According to the method employed under conditions that rendered the results comparable with those of the basic method, the values found for the moisture content of the potato starch used ranged from 16.33 to 16.58%.
A. O. J.

Fanweed Seed Oil. J. R. Clifton and H. O. Triebold (*Ind. Eng. Chem.*, 1944, 36, 218-219)—Fanweed, also known as Frenchweed or pennycress, is *Thlaspi arvense*, a member of the *Cruciferae* which grows abundantly in the north western and north central States of U.S.A. and in south western Canada. In Russia edible oil has been prepared from seeds grown in Siberia. The seeds contain 33 to 35% of oil, which could be used as a salad oil and as a substitute for rapeseed oil in lubricants. A specimen of the oil, extracted with light petroleum, had: sp.gr. at 15°/15° C., 0.9168; n_D^{45} , 1.4652; viscosity (in Saybolt seconds) at 20° C., 426.7; at 37.8° C., 210.2; at 98.9° C., 9.64; acid val., 0.8; sap. val., 177.8; iodine val., 117.3; unsap. matter, 1.34%; insol. fatty acids, 95.7%; Reichert-Meissl val., 0.25; Polenske val., 0.0; hydroxyl val., 8.8; acetyl val., 8.3. *Insol. fatty acids*—m.p., 16°-18° C.; solidif. pt., 10°-12° C.; mean mol. equiv., 301.3; iodine val., 119.3. The fatty acids, estimated by the usual methods, were as follows: myristic, trace; palmitic, 1.5; oleic, 12.5; linolic, 33.0; linolenic, 0.5; erucic, 49.0; lignoceric, 3.5%. Except for the % differences in linolic and oleic acids, the fatty acids are similar to those of rapeseed oil (e.g., linolic 24.0 and oleic 17.0%), and the two oils also resemble each other in physical and chemical properties.

Effect of Relative Humidity on the Determination of Oil in Soya Beans. O. A. Krober and F. I. Collins (*Oil and Soap*, 1944, 21, 2)—Samples of soya bean from various sources were extracted with light petroleum under varying conditions of relative humidity, and the results are tabulated. Two methods of extraction were used: (i) The American Oil Chemists Society method (A.O.C.S. "Official and Tentative Methods of Analysis," 1937), using a Butt extraction apparatus, extracting for 2 hr., re-grinding for 1 min. and extracting for a further period of 2 hr.; (ii) a short method, as (i), but extracting for 1 hr. only in each test. The moisture content of the meal under extraction conditions was determined by means of Karl Fischer reagent (*Angew. Chem.*, 1935, 48, 394) suitably modified. Add 280 g of iodine crystals to a mixture of 1170 ml of dry synthetic methyl alcohol and 450 g of pyridine and mix. Cool in ice and slowly add 220 g of pure, dry sulphur dioxide, shaking occasionally. This reagent is stable for ca. 1 week and should be standardised daily: 150 ml of the freshly-prepared reagent = 1 g of water. The results of the expts. indicate that the amount of extractable material is dependent upon the atmospheric conditions under which the sample is analysed. When meals of 4.35 to 16.8% moisture content are examined at 75-80% relative humidity the amount of extractable material is independent of the original moisture content of the meal, but at lower moisture levels or relative humidities this is not so, the amount of material extracted being less. Under conditions of relatively high humidity with meals of high moisture content, the short 2-hr. extraction gives results comparable with those given by the official 4-hr. method under similar conditions. It is included that the determination of oil in soya bean is empirical and,

to obtain reproducible results, rigid control of the moisture conditions of storage and analysis is essential. J. A.

Biochemical

Accuracy of Haemoglobin Methods. E. J. King, M. Gilchrist and G. E. Delory (*Lancet*, 1944, 246, 239)—Samples of blood from a number of healthy subjects, several hospital blood samples, and solns. of washed, haemolysed red cells were assayed for haemoglobin content, and the oxygen capacity and iron content of each were determined for comparison. The methods employed were: *Alkaline haematin* (Wu, *J. Biochem.*, Tokio, 1922, 2, 173; Clegg and King, *Brit. Med. J.*, 1942, ii, 329)—Mix 0.05 ml of blood with 4.95 ml of 0.1 N sodium hydroxide, heat in a boiling water-bath for 4 min., cool and read the colour against a haemin standard or an Ilford grey screen with a green filter (*cf.* King *et al.*, *Lancet*, 1937, 232, 886). *Cyanmethaemoglobin* (Austin and Drabkin, *J. Biol. Chem.*, 1935, 112, 51 and 89; Drabkin and Austin, *Id.*, 1935, 112, 67; Evelyn and Malory, *Id.*, 1938, 126, 688)—Mix 0.05 ml of blood with 9.85 ml of 0.05 N ammonia, add 0.05 ml of 4% potassium ferricyanide soln., leave for 15 min., add 0.05 ml of 8% sodium cyanide soln., mix and read the colour in a visual or photoelectric colorimeter, using a green filter and a grey screen. *Carboxyhaemoglobin* (Haldane, *J. Physiol.*, 1900, 26, 497; Palmer, *J. Biol. Chem.*, 1918, 33, 119)—Mix 0.05 ml of blood with 9.95 ml of 0.05 N ammonia solution, gas well with pure carbon monoxide and read against a grey screen with a green filter. Several haemochromogen methods (globin, pyridine, picoline and histidine) were discarded after preliminary investigation, while the acid haematin method (Sahli, "*Untersuchungen Methoden*," 6th Ed., 1889; Cohen and Smith, *J. Biol. Chem.*, 1919, 39, 489) was excluded because it lacks precision (*cf.* Clegg and King, *loc. cit.*). Parallel results with these methods are presented in a number of tables and it is concluded that the cyanmethaemoglobin procedure is the most accurate and is the method of choice for research purposes but for routine work the alkaline haematin method is recommended as being quicker and more convenient. It is pointed out that, while the carboxyhaemoglobin method is fairly satisfactory for normal bloods, it may be less accurate with pathological specimens where abnormal haemoglobin may be present. J. A.

Method for the Determination of Coproporphyrin in Urine. H. L. Mason and S. Nesbitt (*J. Biol. Chem.*, 1944, 152, 19-25)—Acidify a 25-ml aliquot portion of urine, containing not more than 5µg of coproporphyrin, with 10 ml of glacial acetic acid and shake with 35 ml of ether. Separate the two layers and extract the urine with two further 35-ml portions of ether. Wash the combined ethereal extracts with several 25-ml portions of water and extract the combined aqueous washings once with 25 ml of ether. Extract the combined ethereal solns., which contain all the coproporphyrin, with at least four 5-ml portions of 5% hydrochloric acid, examining the fourth extract in a fluorophotometer and repeating the extraction if a red fluorescence is observed. Combine the hydrochloric acid extracts and dilute to a convenient vol. With a standard soln. of coproporphyrin (10µg per ml in 5% hydrochloric acid) in the cuvette of a fluorophotometer, fitted with filter No. 511, adjust the intensity of the incident light until the galvanometer reading is almost maximal.

Measure the fluorescence of the extract and repeat the measurement after diluting the extract with 5% hydrochloric acid. The two readings should be proportional. If not, interfering substances are present, and it is necessary to purify the porphyrin as follows. Neutralise the 5% hydrochloric acid soln. to Congo red with solid sodium acetate and, if the vol. is not more than 50 ml, extract as described for urine; if the vol. is greater use larger amounts of ether. Wash the combined ethereal extracts with water and then with 5% hydrochloric acid. This soln. should be free from interfering substances. The method gives results within ±14% of the theoretical. F. A. R.

Nicotinic Acid and Riboflavin in Beef Extracts and Corned Beef. R. G. Booth and E. C. Barton-Wright (*Lancet*, 1944, 246, 565)—Beef extracts, meat juice and a yeast extract have been assayed for their content of nicotinic acid by the method of Kodicek (*Biochem. J.*, 1940, 34, 724) modified in certain instances by the replacement of the 0.4 ml of *p*-aminoacetophenone reagent by 1 ml of a 10% soln. of procaine hydrochloride in 10% hydrochloric acid, which increases the intensity and stability of the colour; this was measured in a "Spekker" absorptiometer using Ilford filter No. 602 (spectrum blue). Riboflavin was determined by the microbiological method of Barton-Wright and Booth (*Biochem. J.*, 1943, 37, 25; *Abst.*, ANALYST, 1943, 68, 339). The following results were obtained:

	Nicotinic acid	Riboflavin
	µg/g	µg/g
Meat extracts:	A	900
	B	1025
	C	410
	D	560
	E	375
Meat juices, concentrated:	F	615
	G	345
"Marmite" yeast extract	655	

Samples A and B were pure extracts without addition of any kind; samples C, D and E contained a proportion of yeast extract and seasoning materials. The nicotinic acid and riboflavin contents of corned beef and fresh beef were also determined:

	Nicotinic acid		Riboflavin	
	µg/g		µg/g	
	As bought	On fat free and dry matter basis	As bought	On fat free and dry matter basis
Corned beef:	A	8.5	24.3	1.55
	B	10.4	29.7	1.1
	C	10.4	29.7	1.6
	D	10.7	30.6	1.8
	E	13.2	37.7	1.66
	F	18.7	53.4	0.7
	G	33.0	94.3	1.85
	H	33.4	95.4	1.6
Beef:	Fresh lean skirt	46	180	} not assayed
	" " buttock	85	331	
	" " leg	71	277	
	" " shin	55	215	
	" " brisket	55	215	
	Roast " sirloin	57	222	

In order to determine whether the substantial loss in vitamin was due to destruction during the processing (the method is briefly described), elution during "pickling" of the corned beef, or both, a sample of corned beef was prepared under controlled conditions and the results of assays conducted on the finished product and the various intermediates are as follows:

100 g of flesh, *R. dumetorum*, 724 mg per 100 g and *R. dumetorum* × *R. mollis*, 941 mg per 100 g. The fertility of the hybrid is extremely low, since although ca. 4000 flowers were carried in June, 1942, only 28 ripe hips were displayed in September and October, the nuts averaging 1.28 per hip compared with 31 in the case of *R. mollis* and 29 for *R. dumetorum*. It is considered that the results are

	Nicotinic acid µg/g		Riboflavin µg/g	
	Moist basis	Dry matter basis	Moist basis	Dry matter basis
Beef:				
Fresh lean	55.4	236	4.6	19.6
"Scalded"	27.1	65.2	3.8	9.2
Pickled (1) No nitrite	11.1	31.7	1.4	4.0
(2) 50 p.p.m. nitrite	12.3	35.2	NA	NA
(3) 100 p.p.m. nitrite	12.0	34.3	NA	NA
(4) 500 p.p.m. nitrite	13.4	38.4	NA	NA
(5) 1000 p.p.m. nitrite	11.7	33.4	1.3	3.7
Pickling liquor (1) } representing	{ 18.3 15.6 18.0 15.6 15.3	—	2.2	—
(2) } 1 g (moist		—	NA	NA
(3) } weight) of		—	NA	NA
(4) } scalded		—	NA	NA
(5) } beef		—	—	—

NA = Not assayed.

The results show that ca. four-fifths of the nicotinic acid is lost on the average during processing, mostly by elution, and the loss of riboflavin is probably a little less. On the basis that an average helping of corned beef is 2 oz., the intake of nicotinic acid is ca. 0.85 mg and of riboflavin 0.05 mg compared with over 4 mg and ca. 0.25 mg respectively for an equal weight of roast beef. Previously published figures for the nicotinic acid content of meat extracts are confirmed. A teaspoonful of extract (ca. 10 g), as used to make a breakfast-cup of beverage, may supply up to 10 mg of nicotinic acid and up to 0.25 mg of riboflavin.

J. A.

New Test for Acetone. J. Ingram (*Brit. Med. J.*, 1944, i, 512)—A reliable and simple modification of Rothera's test (*J. Physiol.*, 1908, 37, 491) is used for the detection of acetone, in urine. Grind 3 g of sodium nitroprusside to a powder, add 100 g of ammonium sulphate and 50 g of anhydrous sodium carbonate and mix well. Store in a dry bottle. For the test, place a small amount of the powder (ca. $\frac{1}{2}$ in.) in a dry test-tube and saturate with the urine under examination. The presence of acetone is indicated by the development of a faint to deep permanganate colour on the powder within two min. A brown colour does not constitute a positive reaction.

J. A.

Ascorbic Acid and Hip Fertility in Rosa Species. J. W. H. Harrison and G. A. D. Jackson (*Nature*, 1944, 153, 404)—The results of investigations of genetical and other problems presented by two species, *R. mollis* var. *typica* and *R. dumetorum* var. *vamealis* and a unique hybrid, *R. dumetorum* ♀ × *R. mollis* ♂ having a chromosome complement of 35, are presented which cast doubts upon the correlations Gustafsson and Schröderheim have sought to establish between low hip fertility and ascorbic acid content (see following abstract). The three forms investigated contained the following amounts of ascorbic acid: *R. mollis*, 1,420 mg per

simply a matter of heredity and that the figures quoted by Gustafsson and Schröderheim are not evidence to the contrary, since reciprocal hybrids involving canine roses are capable of manifesting certain characters in exaggerated fashion, and it is pointed out that the hybrid between "*R. canina*" and *R. rubiginosa* is quoted by Gustafsson and Schröderheim as ripening late, a fact known to be correlated with low ascorbic acid content independently of hip fertility. The results of the mathematical analysis presented by Gustafsson and Schröderheim are not considered to have any real significance because of the genetical heterogeneity of the material assembled, due to the fact that their "*R. canina*" includes 4 series regarded as species by British workers, viz., *R. canina*, *R. dumetorum*, *R. dumalis* (*Afzeliana*) and *R. coriifolia*, the first two characterized by biotypes with low ascorbic values and the latter pair by biotypes containing relatively high amounts. The implied assertion that for full ripening of the *Rosa* receptacle at least one nut must be present is questioned and a hybrid, *R. Sherardi* ♀ × *R. spinosissima* ♂ is quoted having an average of 55% of its hips, usually well developed, with no mature nuts.

J. A.

Ascorbic Acid and Hip Fertility in Rosa Species. A. Gustafsson and J. Schröderheim (*Nature*, 1944, 153, 196)—In previous work (Gustafsson, *Bot. Not.*, 1931; *Hereditas*, 1944 (in prep.); Gustafsson and Håkansson, *Bot. Not.*, 1942) a relation of apparently general importance was discovered between the hip fertility of *R. canina* and the ascorbic acid content. It is stated that hybrids of *R. canina* ♀ form large hips rich in ascorbic acid, but are largely infertile. Reciprocal hybrids, with *R. rubiginosa* ♀, give late-ripening, bottle shaped hips of low ascorbic acid content, being, however, normally fertile. A proof of the assumption that infertility is responsible for the high ascorbic acid content is afforded by a monosomic plant in the *R. rubiginosa* × *canina* series (Pl. 34), which, owing to the loss of one chromosome

(34 instead of 35) has a low fertility, the ascorbic acid content, however, being greatly increased. The following results of detns. are presented:

Schröderheim. It is pointed out that if the suggested negative correlation exists, differences might be expected in the vitamin content of the

	Ascorbic acid as % matter of flesh		Nut content as % of hip weight	
	1941	1943	1941	1943
<i>R. canina</i>	1.9	2.9, 2.4	27	31, 32
<i>R. rubiginosa</i>	3.0	3.3, 3.4	24	33, 32
<i>R. canina</i> × <i>rubiginosa</i>				
Pl. 1	3.9, 4.6	4.1, 4.1, 3.9	11, 13	11, 16, 10
Pl. 2	4.4	4.3, 4.0, 4.4	9	13, 10, 11
Pl. 3	—	4.1, 3.9	—	12, 12
Pl. 4	5.1	3.9, 4.0, 4.3	12	10, 11, 9
Pl. 5	—	3.9, 5.0, 4.2	—	8, 8, 8
Pl. 6	—	4.2, 4.1	—	16, 15
<i>R. rubiginosa</i> × <i>canina</i>				
Pl. 1	2.2	—	44	—
Pl. 4	2.0	—	49	—
Pl. 21	—	2.8	—	35
Pl. 51	—	2.1	—	44
Pl. 34 (2n=34)	5.1	4.6, 4.2	21	27, 22

The negative correlation of hip-fertility and ascorbic acid content was further demonstrated for 3 other sets of material: (1) 155 different spontaneous *R. canina* individuals (mostly belonging to the *R. eucania* and *afzeliana* complexes) (2) series of samples taken from 41 different parcels for industrial production in 1943; (3) samples of 164 *R. rugosa* individuals.

hips from individual bushes from year to year, according to the number of nuts matured. The figures given by Gustafsson and Schröderheim for *R. canina* and Schröderheim for *R. canina* and *R. rubiginosa* are contrary to this theory. The mathematical analysis is criticised on the grounds that the lowest and least significant correlation is obtained for a single species, *R. rubiginosa*, while

Material	Av. fruit content % of hip wt.	Av. ascorbic acid content % of dry matter of hip flesh	Correlation coeff.	Regression coeff.	P
1	34.76	2.82	-0.21	-0.037	0.01-0.1
2	31.63	2.50	-0.75	-0.120	<0.01
3	20.82	3.50	-0.17	-0.032	0.02

The *P*-values were determined by analysis of the co-variance, and the regression coefficient; e.g., -0.037, indicates an increase of 0.037% in ascorbic acid content per 1% decrease in fruit content. It is suggested that this phenomenon may be due to the ascorbic acid taking a direct part in the seed and nut development, whence, if for some genotypical or environmental cause, the nuts are few in number, it is stored up in the receptacle and not consumed. The results indicate the necessity of a reconsideration of the connection between the chromosome number and vitamin C content of apples, tomatoes and other fruits; in apples especially, the high vitamin C content of triploids as compared with diploids may be conceived as due to infertility as well as the chromosome number and the genotype. Finally, it is stressed that for full ripening of the *Rosa* receptacle only one or two fruits are necessary. J. A.

Ascorbic Acid and Hip Fertility in Rosa Species. R. Melville (*Nature*, 1944, 153, 404)—Earlier data (Pyke and Melville, *Biochem. J.*, 1942, 36, 336) concerning rose hips as a source of vitamin C have been re-examined. For *R. canina*, a mean vitamin C content of 493 mg per 100 g of hip flesh and a mean nut content of 39% was found, while for *R. Afzeliana*, the figures were 1121 mg and 36% respectively. It is pointed out that the effect of mixing data from two such species would be to produce a false negative correlation between the ascorbic acid content and the nut content. Data for an extensive series of observations on *R. canina*, summarised in a table, are shown to be unfavourable to the hypothesis of Gustafsson and

the only high correlation is for a heterogeneous mixture which, it is suggested, may be due to an increased mingling of species having high vitamin and low pip content with others of low vitamin and high pip content; specific differences have been observed in British roses to tend in these directions and are independent of fertility. J. A.

Thiourea as Protective Agent for Vitamin C. E. Kawereau and W. R. Fearon (*Sci. Proc. Roy. Dublin Soc.*, 1944, 23, 171)—A large number of substances which might be capable of protecting vitamin C from oxidation in presence of copper have been investigated, and thiourea was found to have an outstanding effect. It is excreted unchanged by the kidneys after administration to human subjects and appears to be of very low toxicity. Further long-term expts., however, will be necessary before its large-scale use can be advocated. It is pointed out that boiled vegetable extracts have a similar power of protection which, in some instances, is so complete as to suggest the presence of specific stabilisers, possibly of the thiol class; cabbage, in fact, contains an unidentified volatile thiol compound, while potato juice yields an active distillate on boiling. J. A.

Rôle of Phosphate in the Methylene Blue Reduction by Dehydroascorbic Acid. L. Frankenthal (*Nature*, 1944, 153, 255)—Attention is directed to a previous publication by the author (*Enzymologia*, 1939, 6, 287) where it was shown that dehydroascorbic acid, or its irreversible product, diketogulonic acid, reduced methylene blue at a rate increasing with increasing pH from 6.5 to 8.5,

the reaction depending on presence of phosphate. It is pointed out that Penney and Zilva (*Biochem. J.*, 1943, **37**, 403) reported expts. which support this conclusion without, however, noting the part played by phosphate, and it is again suggested that this phenomenon suggests a likely explanation of the discrepancies between the findings of Borsook *et al.* (*J. Biol. Chem.*, 1937, **117**, 237), who used McIlvaine phosphate buffer, and Ball (*J. Biol. Chem.*, 1937, **118**, 219) working with acetate buffer.
J. A.

Determination of Ascorbic Acid in Presence of Interfering Substances, Notably Reductones. L. F. Levy (*Biochem. J.*, 1943, **57**, 714-716)—Attempts to estimate vitamin C in biscuits fortified with conc. orange juice showed that the original biscuits gave a high titre with .2:6-dichlorophenolindophenol soln. owing to the presence of reductone-like substances. Investigation showed that at pH 3 the dye reduces both ascorbic acid and reductones, but that in presence of at least 20% of HCl (actual) only reductone is titrated. The difference between the two titres represents the ascorbic acid present and the value thus obtained can be checked by diluting the second soln. and continuing the titration. The titration of ascorbic acid with iodine is also affected by the addition of conc. hydrochloric acid. The procedure is applicable when sodium thiosulphate is present. Ascorbic acid can also be estimated in urine by the differential titration method but, as urine darkens appreciably on addition of hydrochloric acid, the end-point with indophenol is difficult to see. With iodine, however, the end-point is readily seen in the pink colour of the chloroform layer.
F. A. R.

Bacteriological

Effect of Increase in Acidity on Antiseptic Efficiency. O. Rahn and J. E. Conn (*Ind. Eng. Chem.*, 1944, **36**, 185-187)—Benzoic acid, salicylic acid and sulphurous acid are nearly 100 times more effective in strongly acid than in neutral solutions. With benzoic and salicylic acids, only the undissociated acid is antiseptic; the benzoate and salicylate ions appear to have practically no effect on yeast. Multiplication of the yeast (*Saccharomyces ellipsoideus*) used as test organism was inhibited whenever the undissociated benzoic acid concn. was above 25 mg per 100 ml. With salicylic acid, the limiting concn. was 4 mg of undissociated acid per 100 ml. Sulphur dioxide in water is dissociated to inert SO_3^2- ions and to HSO_3^- ions which inhibit the multiplication of *B. coli* but not of yeast, which is inhibited only by undissociated H_2SO_3 . From 7 to 8 mg of undissociated H_2SO_3 per 100 ml rapidly kill yeast; *B. coli* can tolerate *ca.* 10 times as much. The different efficiency of undissociated molecules and ions of the same acid may be explained by the fact that it is difficult for ions to permeate living cell membranes.

Water

Tests for Active Residual Chlorine and Chloramine in Water. F. J. Hallinan (*J. Amer. Water Works Assoc.*, 1944, **36**, 296-302)—Measurement of the concn. of free chlorine and of chloramines by the *o*-tolidine method is made possible by applying the principle of the comparator. To three 50-ml portions of the water add (i) sodium arsenite soln. followed by the *o*-tolidine reagent; (ii) *o*-tolidine reagent followed by sodium arsenite

soln.; (iii) *o*-tolidine reagent only. The difference in colour between the first and second of these solutions is due to free chlorine and is measured by matching with the usual standards. Similarly, the difference between the second and third solns. is due to chloramines only. Interference by other oxidising agents is prevented.
D. D.

Organic

Application of the Ferric Thiocyanate Method to the Determination of Incipient Rancidity in Fats and Oils. A. Lips, R. A. Chapman and W. D. McFarlane (*Oil and Soap*, 1943, **20**, 240)—The ferric thiocyanate method, previously described (Chapman and McFarlane, *Canadian J. Res.*, 1943, **B21**, 193) for the determination of fat-peroxides in milk powder and modified for use in the development of a practical antioxidant for lard (Lips and McFarlane, *Oil and Soap*, 1943, **20**, 193) has been applied to the study of incipient rancidity in fats and oils. **Reagent**—Dissolve 0.4 g of ammonium thiocyanate in 4 ml of water in a 100-ml graduated flask, leave for 5-10 min., dilute nearly to volume with anhydrous acetone and mix thoroughly. Add 0.1 g of ferrous ammonium sulphate, dilute to the mark with anhydrous acetone and shake thoroughly. Leave in the dark for 2 hr. with frequent shaking, and decant from the undissolved ferrous salt. Acetone must have been distilled from a small quantity of ferric chloride, dried with calcium chloride and redistilled; spent solvent must be dried and redistilled before use. **Method**—Dissolve a representative sample of about 0.1 g of the fat in 25 ml of anhydrous acetone, warming gently if necessary. Transfer 1 ml of the soln. to a test-tube, add 9 ml of the reagent, and heat at 70°-80° C. until the first evolution of gas occurs, then continue the heating at 50° C. for 10 min. Determine the intensity of the colour spectrophotometrically, at 485m μ , using pure acetone as blank. Conduct a blank determination on 1 ml of pure acetone in place of the fat soln.; correlate each reading with the amount of ferric iron present in the soln. by reference to a graph constructed from readings obtained by applying the test to solns. of ferric chloride (0.2 to 14.0 μ g per ml) in purified anhydrous acetone, and subtract the value for the blank from that for the test. Calculate the total peroxides, using the following formula—

$$\text{mg-equiv. of peroxide per kg of fat} = \frac{A \times B}{C \times 55.84}$$

where A = μ g of ferric iron in 10 ml of test soln. minus μ g of ferric iron in 10 ml of reagent blank; B = vol. of fat soln. (25 ml); C = wt. of sample in g.

The reagent, which has a faint pink colour, must be kept in the dark to retard the gradual increase in the intensity of the colour; the determination must be made in a red light, as sunlight or strong electric light intensifies the colour. The presence of citric acid in the fat under examination causes marked diminution of the colour if the amount exceeds 250 p.p.m. This effect may be prevented by adding 5-10% of acetic acid to the reagent, while acetone containing 10% of acetic acid is recommended as the fat solvent for oils rich in phospholipids; its use should be restricted to special instances since it causes gradual intensification of the red colour of ferric thiocyanate. Results obtained by the above method are compared with those obtained iodimetrically and in every test peroxide values obtained colorimetrically are *ca.* twice the iodimetric values. The oxygen absorbed by various

fats and oils on storage, calculated from change in peroxide value determined colorimetrically, is in good agreement with direct measurements in a Warburg-Barcroft manometric apparatus when the equivalent wt. of peroxide oxygen is assumed to be 8. It is stated that the proposed method is simpler and more sensitive than any previously described and is recommended particularly for the detection of incipient rancidity in vegetable oil products. J. A.

Antioxidant Properties of Nordihydroguaiaretic Acid. W. O. Lundberg, H. O. Halvorson and G. O. Burr (*Oil and Soap*, 1944, 21, 33)—After favourable preliminary results, the antioxidant properties of nordihydroguaiaretic acid have been investigated. This substance, represented by the following formula:

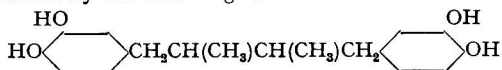

can be obtained in good yield (ca. 7% on dry) from the common desert plant, *Larrea divaricata*. It is only very slightly soluble in water; it is appreciably soluble in hot fats and shows no tendency to crystallise out on cooling, the solubility being greater than that of hydroquinone, but less than that of the tocopherols. Expts. are described which indicate that, at concns. up to ca. 0.1%, the acid has no deleterious effect on the qualities of lards and that it compares favourably in its antioxidant properties with other highly effective inhibitors of the phenolic type. It is further shown that its effectiveness in stabilising fats is, to some extent, carried over into baked products, while its efficacy is enhanced by the presence of ascorbic acid. J. A.

Modified Kreis Test applicable to Cosmetic Preparations. J. H. Jones (*J. Assoc. Off. Agr. Chem.*, 1944, 27, 128-130)—It has been shown that the colour produced with phloroglucinol in the Kreis test for deterioration in oils is due to epihydrin aldehyde probably present as an acetal from which it is liberated by conc. hydrochloric acid. Although conc. acid is necessary for liberation of the aldehyde, the absorption can be made in dil. acid without loss of sensitivity of the test or interference by perfumes, flavours or essential oils. For solid cosmetic preparations the usual solvents, viz., benzene and kerosene, are not entirely satisfactory, but mineral oil prevents pptn. of paraffin, beeswax, etc., which are frequent components of these preparations. To construct a convenient aeration apparatus connect in series three 1 x 6 in. test-tubes provided with rubber stoppers carrying long inlet tubes and short outlet tubes. The first test-tube serves as aerator, the second, loosely packed with glass wool, as a filter to remove entrained oil, and the third as absorber. The absorbent is a 0.2% soln. of phloroglucinol in dil. hydrochloric acid (1 + 9) prepared fresh daily. Weigh liquid samples (2-10 g), consisting essentially of oils, directly in the aeration tube. Treat solids or emulsions, containing at least 50% of oil, in the aeration tube with ca. 2 vols. of mineral oil, heat the mixture in a water-bath, mix thoroughly and cool to room temp. Evaporate emulsions containing a low % of oil in a vacuum desiccator at room temp. until the oil content is over 50% before mixing with mineral oil as previously described. Place 2 ml of the absorbent for each g of oil in the sample in the absorption tube, add to the prepared sample in the aeration tube an equal vol. of conc. hydrochloric acid (37%) and pass air rapidly through the

apparatus for 30 min. A pink colour in the absorbent denotes deteriorated oils. A yellow colour or turbidity should be disregarded. The following substances used in cosmetic preparations did not give positive reactions—anisic aldehyde, anethole, benzaldehyde, camphor, coumarin, ethyl vanillin, eucalyptol, geraniol, *n*-heptaldehyde, heliotropin, β -ionone, *iso*-eugenol, *iso*-safrole, menthol, phenylacetaldehyde, phenylethyl alcohol, terpineol, vanillin, oils of bay, bergamot, cloves, citronella, lemon, orange, patchouli, peppermint and pine. Cinnamic aldehyde, eugenol, oil of cinnamon and oil of cassia gave a yellow colour that could not be mistaken for that in the positive reaction. Attempts to use this procedure for quantitative purposes were not successful, but, if 2 ml of absorbent are used for each g of oil in the sample, fresh oils give no colour, slightly deteriorated oils give a light pink colour and decomposed oils a deep pink colour. The mineral oil used should be U.S.P. light mineral oil or a similar grade. A. O. J.

Inorganic

Nomenclature of Alloys (*J. Inst. Metals*, 1944, 70, xviii)—The Nomenclature Committee of the Institute of Metals recommends that in future the practice adopted in the Institute's publications with regard to alloy nomenclature shall conform with current usage elsewhere. When an alloy is named by stating the chief elements it contains before the word "alloy," the elements will be given in the order:—(1) the element present in largest proportion, followed by (2) the other elements present. These will be stated in order of descending proportion by weight, except in a very few instances where another order is well established. For these the customary order will usually be followed. The use of established terms and expressions such as brass, bronze, leaded gun-metal, is not in any way affected. Examples of the new nomenclature are: 98% aluminium, 4% copper—an aluminium-copper alloy; 94% magnesium, 5% aluminium, 1% zinc—a magnesium-aluminium-zinc alloy. The new rule reverses the recommendation of the Institute's 1914 Committee on Nomenclature of Alloys, but it is emphasised that it applies only when the word "alloy" is present. It should be noted that in such terms as "phosphor bronze" and "beryllium copper," where the word "alloy" is absent, the name of the minor constituent precedes that of the major one. B. S. C.

Analysis of Cyanide Brass Electroplating Solutions. S. G. Clarke, W. N. Bradshaw and E. E. Longhurst (*J. Electrodepositors Tech. Soc.*, 1944, 19, 78-86)—Existing methods have been investigated and new ones devised, where necessary, for the determination of free cyanide, copper, zinc, ammonia and pH. *Free Cyanide*—To a 10-ml sample add 10 ml of 10% potassium iodide soln. and 3 g of solid sodium hydroxide. Add 70 ml of water, stir to dissolve the sodium hydroxide and titrate with *N*/10 silver nitrate, stirring after each addition, until a permanent turbidity is formed. This determines free sodium cyanide plus the cyanide which is combined in the zinc complex $\text{Na}_2\text{Zn}(\text{CN})_4$, the cyanide combined in the copper complex, $\text{Na}_2\text{Cu}(\text{CN})_6$, remaining unaffected. The cyanide combined with zinc must therefore be deducted from the result: each 1 g of zinc per litre of the original soln. is equiv. to 3.00 g of sodium cyanide. 1 ml of *N*/10 silver nitrate \equiv 0.0098 g NaCN. For high-zinc baths, it is better to take a

5-ml sample, adding 15 ml of water, 10 ml of potassium iodide soln. and 5 g of sodium hydroxide. The final vol. at the end of the titration should be approx. 100 ml. **Copper**—Add 5 ml of conc. nitric acid to a 10-ml sample, and evaporate to low volume to remove hydrogen cyanide and excess nitric acid. If any ppt. is present at this stage (if ferrocyanide is present), add 5 ml of conc. sulphuric acid and evaporate until white fumes appear. Determine copper iodometrically in the usual manner. **Zinc**—The method depends on the reaction between potassium ferricyanide, a zinc salt and potassium iodide, which, in a soln. slightly acidified with sulphuric acid, yields iodine in proportion to the zinc present (*cf.* also R. Lang, *Z. Anal. Chem.*, 1929, 79, 161). To a 20-ml sample (5 ml if a high-zinc bath) add 30 ml of water and 10 ml of dil. (1 : 3) sulphuric acid. This ppt. the bulk of the copper as cuprous cyanide. Dilute to 100 ml and filter through a dry filter-paper. Boil a 50-ml aliquot portion of the filtrate with 2 ml of conc. nitric acid for 5 min. to remove hydrocyanic acid, cool, neutralise with sodium carbonate soln., render just acid to methyl red indicator with dil. (1 : 3) sulphuric acid, and add exactly 5 drops in excess. Add 10 ml of 10% potassium iodide soln. and 5 ml of 1% starch soln. and discharge any blue colour with the min. number of drops of *N*/10 sodium thiosulphate. This prepares the soln. for the zinc determination. Add 10 ml of 5% potassium ferricyanide soln. and titrate with *N*/10 sodium thiosulphate, with stirring, to a greenish-yellow endpoint. 1 ml of *N*/10 thiosulphate \equiv 0.00995 g of zinc. If the end-point is white, it indicates a deficiency of ferricyanide, and a few more ml must be added and the titration completed. If ferrocyanide is present in the original soln., destruction of all cyanide and separation of iron is required. **pH Value**—For colorimetric testing in the usual range, pH 9.5–11.5, Alizarine Yellow GG is used with permanent colour standard solns (ANALYST, 1943, 68, 244). For a higher range, pH 11.2–12.8, Tropaeolin O is used. Add 0.5 ml of the commercial indicator soln. to 5 ml of the sample in a pH tube and, after mixing, match in daylight against artificial colour standard solns. contained in similar tubes. The supply of indicator solution used should be first checked by test in a buffer soln. to determine the quantity to be added to the test soln. to yield the correct depth of colour of the appropriate buffer standard. The composition of the solns. is as follows:—

pH	Artificial standards		Buffers	
	20 ml of FeCl ₃ ·6H ₂ O soln. (58.5 g/litre) mixed with the quantity of 7% CoSO ₄ ·7H ₂ O soln.	as below	Na ₂ HPO ₄ ·12H ₂ O g per litre	NaOH g per litre
11.2	3.0 ml		107.5	6.2
11.4	3.95 "		"	7.6
11.6	6.05 "		"	9.6
11.8	8.6 "		"	10.8
12.0	10.05 "		"	11.6
12.2	13.1 "		"	12.8
12.4	15.8 "		"	14.0
12.6	17.3 "		"	15.6
12.8	19.0 "		"	18.2

Ammonia—Acidify a 25-ml sample with acetic acid and dilute to about 100 ml. Add 10% silver nitrate soln., with stirring, until no further ppt. is formed, to ppt. all cyanide. Filter off the ppt. and distil off the ammonia from the filtrate with sodium hydroxide in

the usual manner for the determination of ammonia. The prior removal of cyanide with silver nitrate avoids any danger of production of ammonia by hydrolysis of cyanide in the course of the determination. S. G. C.

Electrolytic Determination of Copper in Cast Iron and Steel. W. S. Levine and H. Seaman (*Ind. Eng. Chem., Anal. Ed.*, 1944, 16, 80–82)—Dissolve 5 g (or less for copper contents higher than 0.5%) in 92 ml of water and 8 ml of strong sulphuric acid in a tall 200-ml covered beaker, heating until dissolved. Wash down the sides of the beaker, boil after adding 5 ml of 12.5% ferric sulphate soln. in 6% sulphuric acid or 15 drops of nitric acid to dissolve the copper. When this is done the soln. should still contain some ferric iron (thiocyanate spot test). Filter if necessary, dilute to 150 ml and electrolyse at 15°–18° C. with 0.1 amp. and 2.2 volt. The apparatus described comprises a platinum gauze cathode, a platinum wire anode enclosed in an aluminum thimble containing 4% sulphuric acid, and a tube for bubbling air through the soln. Continue the electrolysis for ca. 45 min., test a drop of electrolyte on a spot plate by stirring-in 3 drops of strong nitric acid until the black colour disappears, then 2 drops of strong phosphoric acid and 2 drops of 0.2% sodium diethyldithiocarbamate soln. A yellow colour indicates copper. Steels containing more than 0.2% of Mo give high results by deposition of an oxide of molybdenum. The deposit must be dissolved in nitric acid and the copper determined colorimetrically. This applies also to tungsten and high chromium steels. W. R. S.

Determination of Small Amounts of Molybdenum in Plants and Soils. M. L. Nichols and L. H. Rogers (*Ind. Eng. Chem., Anal. Ed.*, 1944, 16, 137–140)—The paper gives a detailed description of spectrographic, colorimetric, and polarographic methods. The colorimetric procedure (ether extraction of the soln. treated with thiocyanate and stannous chloride) is preferred if at least 1 g of soil or 10 g of air-dried plant material is available; otherwise the spectrographic method is preferable. The polarographic process has no advantages over the other two. W. R. S.

Separation of Manganese from other Metals by Pyridine. J. I. Watters and I. M. Koltzoff (*Ind. Eng. Chem., Anal. Ed.*, 1944, 16, 187–189)—A large quantity of iron, and even small quantities of chromium, vanadium, and cerium, interfere in the authors' polarographic determination (ANALYST, 1943, 68, 194). These elements may be eliminated by pptn. with pyridine. Ostroumow (ANALYST, 1936, 61, 723), by boiling the soln., secured quantitative pptn. of chromic ion without adding iron, but Lingane and Kerlinger (ANALYST, 1941, 66, 259), working in cold soln. found that the removal of chromium by means of pyridine in steel analysis is due to co-pptn. with the iron. In the procedure given below, ferric iron induces quantitative pptn. of not more than the following relative amounts, corresponding to percentages in the respective ferro-alloys: 34% Cr^{III}, 18% V^V, 33% Ce^{IV}, 20% Ce^{III}. Chromate must be reduced to chromic salt; vanadyl ion is completely pptd. by pyridine in presence of ferric iron; manganese and ferrous ions are not pptd. Treat the soln. with 5 ml of nitric acid (1 : 3) and 1 ml of 20% sodium bisulphite soln. to reduce chromate, boil to expel sulphur dioxide and re-oxidise ferrous salt. Neutralise

with ammonia, transfer to a 100-ml graduated flask, add 1 ml of sulphuric acid (1 : 1) and dilute to ca. 80 ml. Swirl and slowly add 15 ml of pyridine soln. (1 : 2). Dilute to 100 ml, mix well, filter through dry paper, transfer 50 ml to a 100-ml flask and determine manganese polarographically.

W. R. S.

Determination of Sodium in Potassium Hydroxide. D. Williams and G. S. Haines

(*Ind. Eng. Chem., Anal. Ed.*, 1944, 16, 157-161)—Dissolve 1 g in 10 ml of water in a tall 180-ml beaker, add a drop of phenolphthalein soln., neutralise with 70% perchloric acid drop by drop and add 1.0 ml in excess. Cautiously evaporate on a hot plate until dense white fumes appear, and keep fuming for $\frac{1}{2}$ min. When the ppt. is cold extract it four times with 5-ml portions of isopropanol (*Caution*: do not add the alcohol to the hot assay) added from a small fine-tipped wash-bottle, stirring well and breaking up any lumps, and decanting each time through a Gooch crucible containing a disc of Whatman No. 40 paper. Transfer the ppt. to the crucible with the last portion, wash the beaker and then the crucible once with isopropanol, transfer the filtrate to a dry 180-ml beaker and rinse with a minimum of the alcohol. To the soln., measuring ca. 25 ml, slowly add 10 ml of reagent with swirling (160 g of uranyl acetate dihydrate, 180 g of magnesium acetate tetrahydrate, and 45 g of glacial acetic acid; dissolve in 750 ml of water at 75° C., cool, dilute to 1000 ml, and filter). Swirl for 20 sec., set aside for 10 min., filter through a tared Gooch crucible fitted as above, transfer the ppt. and wash it with 4 or 5 portions of isopropanol (not more than 25 ml in all). Dry for 5 min. at 105°-110° C., cool and weigh. Factor for NaOH: 0.0261. Divide the result by 0.94 (correction factor for recovery loss).

W. R. S.

Elimination of Nitrate Impurity from Hydrogen Peroxide. E. C. Cantino

(*Ind. Eng. Chem., Anal. Ed.*, 1944, 16, 181-182)—An apparatus is described and sketched in which 30% hydrogen peroxide is passed through a water-cooled column of alternating layers of activated carbon (Columbia brand, type F, size 20/48), glass beads, glass wool, and perforated porcelain discs. The column is mounted on a receiver to which suction is applied. A quantity of 35 g of carbon was found sufficient to purify over 500 ml of hydrogen peroxide; the purified reagent contained 27-29% of H₂O₂ and less than 10 p.p.m. of nitrate. The thickness of the carbon layers and the distance between them are important in preventing undue heating and decomposition.

W. R. S.

Microchemical

Potassium Ethyl Xanthate as Analytical Reagent. Separation of Copper from Nickel. P. Wenger, Z. Besso and R. Duckert (*Helv. Chim. Acta*, 1944, 27, 291-293)—Experimental separation and gravimetric micro-determination of copper and nickel have been achieved by pptng. the copper as xanthate from slightly ammoniacal solns. Nickel remains in the filtrate and is determined by pptn. with dimethylglyoxime. *Method*—To 2 ml of soln. containing about 2 mg each of copper and nickel as sulphates add 1 ml of water and 6 drops of conc. ammonia soln. Stir briskly, add all at once 1.5 ml of a fresh 2% aqueous soln.

of potassium ethyl xanthate and stir until the ppt. flocculates. If it is not a pure golden yellow in colour add a little more ammonia. Leave for 15 min., filter on a filter-stick and wash with 1% ammonia soln. Dissolve the ppt. in a little conc. nitric acid and evaporate to dryness. Add water, evaporate again, dissolve the residue in 1-2 ml of water and filter the soln. Add sodium acetate soln. to adjust the pH to between 5 and 6, add 1.2 ml of 1% alcoholic salicylaldehyde soln., stir and leave for 20 min. Filter through a weighed filter-tube and give several washes alternately with water and alcohol. Dry at 105° C. and reweigh (Cu factor = 0.1893). Nickel is determined simply by adding 1.5 ml of 1% alcoholic dimethylglyoxime soln. to the filtrate from the copper xanthate, warming to 70° C. and continuing as usual. A glass Gooch micro-crucible is preferred to the Prgl filter-tube for handling the nickel ppt. L. A. D.

Microscopical Identification of Sodium and Potassium by means of their Crystalline Picrolonates. W. V. Eisenberg and G. L. Keenan

(*J. Assoc. Off. Agr. Chem.*, 1944, 27, 177-179)—The reagent consists of a 0.5% soln. of picronic acid in 50% alcohol, and a drop is applied directly to the material or to a drop of test soln. on a microscope slide and gently warmed. Small masses or circular aggregates of yellow rods and needles quickly form. With solid material the needles appear to emerge directly from the fragment; with solns. the needles may appear at the edge of the drop, and it is necessary to stir while warming to induce crystallisation throughout the drop. The material formed on the slide is allowed to dry at room temp. and the yellow crystalline ppt. is transferred to another slide for examination with the polarising microscope and for examination of its refractive properties by the immersion method. With sodium compounds the small rods and needles are distinctly doubly refracting with parallel extinction and negative elongation when examined with crossed nicols (plane polarised light). The commonly occurring refractive index ($n_{\alpha} = 1.616$) is shown when the rods and needles are oriented with their long dimension parallel to the vibration plane of the lower nicol. The max. refractive index (n_{γ}) is greater than that of methylene iodide (1.734) and is shown crosswise on the crystals. Twenty sodium salts answered to the test without difficulty. Potassium salts, by the same procedure, yield a crystalline ppt. scarcely distinguishable by appearance from the sodium compound but readily differentiated by its refraction and polarisation. It exhibits inclined extinction with negative elongation, and n_{α} (1.505) is much lower than the corresponding index of the sodium salt. An intermediate index ($n_1 = 1.519$) is shown frequently and n_{γ} , as for the sodium salt, is higher than that of methylene iodide. Twenty-two potassium salts answered to the test without difficulty. The crystals form readily with 28 μ g of sodium ion or 38 μ g of potassium ion. Calcium, barium, strontium, ammonium, lithium, lead, copper and magnesium ions interfere and must be removed. Calcium and lithium form very fine wavy trichites, barium a yellow amorphous ppt., lead a flocculent mass of minute needles, and magnesium compact circular masses of minute needles, all unsuitable for optical study. Ammonium and strontium yield crystals differing in habit and optical properties from those of sodium and potassium. Copper yields crystals somewhat similar to those of sodium and potassium but with different optical properties. The test is

most effective when applied to dry physical mixtures, e.g., in food and drug products, where the unknown material may be isolated as minute fragments under a low-power microscope. A. O. J.

Physical Methods, Apparatus, etc.

Use of Briquets for the Spectrographic Analysis of Steel. R. E. Nusbaum, D. L. Fry and J. W. Hackett (*J. Opt. Soc. Amer.*, 1944, 34, 33-40)—Briquets, ca. $\frac{1}{4}$ in. diam. and $\frac{1}{8}$ in. long, are formed from particles, smaller than 150-mesh, obtained as grindings from a suitable portion of the steel sample. Grinding wheel particles are separated from the metal grindings by either a magnetic or electrostatic separator. Two % of high purity carbon is thoroughly mixed with the samples before pressing into briquets with a pressure of over 100,000 lbs./sq. in. The advantages of the method are: (1) Briquets can be prepared from original samples of almost any shape or size and those not easily machined; (2) segregation errors are minimised; (3) standard samples can be conveniently prepared by the same method, e.g., by mixing grindings of two or more steels of known composition. The accuracy of the method compares very favourably with that for cast pins or rods. Applications to the determination of manganese, silicon, chromium and molybdenum are described. B. S. C.

Spectrochemical Analysis of Metals with the Multisource Unit. M. F. Hasler and J. W. Kemp (*J. Opt. Soc. Amer.*, 1944, 34, 21-32)—With an A.R.L.-Dietert controlled multisource (Hasler and Dietert, *J. Opt. Soc. Amer.*, 1943, 33, 218) it is possible to obtain spectra representing an almost continuous gradation from arc-like to spark-like. In addition to the two extreme sets of conditions, this unit can be adjusted to give a wide variety of intermediate sources. This makes it possible to effect a reasonable compromise between sensitivity and precision in the solution of any given problem, and also to solve difficult problems arising from the effect of one element on another, differences in metallurgical history of samples, etc. Details are given of analyses with the multisource of various alloys of iron, aluminium, magnesium and zinc. In each instance practical working conditions are found which, in general, represent improvements over those obtained with conventional arcs or sparks. B. S. C.

Application of Multiplier Photo-tubes to Quantitative Spectrochemical Analysis. E. A. Boettner and G. P. Brewington (*J. Opt. Soc. Amer.*, 1944, 34, 6-11)—The photographic plate in a spectrograph can be replaced by two electron multiplier tubes, the first receiving the energy from a suitable spectrum line of the constituent to be determined, whilst the second receives that from a suitable internal standard comparison line. In the most promising method of operation, the voltage applied to the first tube is kept constant, whilst that on the second tube is adjusted to obtain balance in the bridge circuit in which the two tubes are connected. The plot of the log. concn. of the impurity against the difference of voltage applied to the two tubes is then a straight line. The method has been applied to the determination of calcium, aluminium and silicon in 25% sodium hydroxide soln., using the A.C. arc, and to the determination of aluminium and zinc in magnesium

alloys, using the spark. This preliminary investigation shows that the method can equal the accuracy and sensitivity possible with a photographic plate. Some indication has been obtained that, with suitable light sources, a method could be devised in which impurity concn. could be read directly from the galvanometer readings resulting from unbalance of the bridge. B. S. C.

Spectrographic Determination of Traces of Sodium in Pure Aluminium. F. Rohner (*Helv. Chim. Acta*, 1944, 27, 268-273)—Aluminium rods, 4.5 mm diam., are used as electrodes, excitation being by the Pfeilsticker interrupted arc technique. With a current of 2 amp. and interruption of 100 times a second, it is possible to determine the sodium content down to 0.0005%. For calibration gravimetrically analysed standards are used; a relation can be obtained between the sodium concn. and the difference in density of the sodium line 5889.95A and the "AIO" band head 4842.2A. An accuracy of $\pm 12\%$ of the amount of sodium present is claimed. [Note—"AIO" is a spectroscopic term used to indicate the unstable "molecule" which exists momentarily in the electric discharge and gives rise to the spectral emission band used for the intensity estimation.—ABSTRACTOR.] B. S. C.

Polarographic Determination of Copper, Lead and Cadmium in High-purity Zinc Alloys. R. C. Hawkings and H. G. Thode (*Ind. Eng. Chem., Anal. Ed.*, 1944, 16, 71-74)—A study has been made of the polarographic method of determining traces of elements (down to $1 \times 10^{-4}\%$) in zinc-base die casting alloys. Traces of lead, cadmium and tin cause intergranular corrosion which results in weakening of the alloy. For the direct-polarographic determination of copper, cadmium and lead in these alloys, dissolve the sample in hydrochloric and nitric acids, evaporate the soln. nearly to dryness, dissolve the residue in dil. hydrochloric acid, treat with hydroxylamine hydrochloride soln. and make up to volume. Electrolyse this soln. cathodically over a range of approx. -0.8 volt to obtain waves for copper, lead and cadmium. Using an 8 g samples in 50 ml of soln., these elements can be determined with a precision of $\pm 1 \times 10^{-4}\%$ of the sample weight. National Bureau of Standards zinc samples thus analysed have given results agreeing well with the certificate values. Samples of high-purity zinc and zinc alloys have been analysed without difficulty. The possible interference of the following elements has been considered: Ni, Co, Mn, Ag, As, Hg, Tl, Bi, Sb, Al, Fe, Ge, Ga, In, Mg and Sn. The results indicate that traces of copper, cadmium and lead can be determined polarographically with high precision and accuracy.

Apparatus for Measuring Gas Transmission through Sheets and Films. H. R. Todd (*Paper Trade J.*, 1944, 118, 9th Mar., T.A.P.P.I. Sect., 84-87)—In existing methods gas is caused to pass through a specimen by applying atm. pressure on one side and a vacuum on the other, and the rate of permeability is indicated manometrically. It is now pointed out that if the vol. of gas transmitted is measured directly by the movement of a column of suitable liquid (e.g., mercury or water, according as the test is made under dry or humid conditions, respectively) through a horizontal capillary tube of known cross-sectional area, and if the vol. of the gas on the measuring side is as small as possible, the sensitivity of the apparatus may be increased

considerably. In the apparatus described the chambers on the 2 sides of the sample have vols. of 500 and 10 ml, and are maintained *in vacuo* and at atm. pressure, respectively, so as to ensure a differential pressure of 635 mm of mercury. Gas-tight seals between the chambers and the specimen are ensured by rubber gaskets, cemented into, and partly projecting from, grooves cut in the face of each flange. The glass capillary measuring tube (length, 31 in.; internal diam., 1.8 mm) is graduated with a mm-scale, so that it can be read to within 0.5 mm. For a 24-hr. test-period the sensitivity obtainable is 0.019 ml per 100 sq. in. per 24 hr. Tests should be made at 1° and 36.7° C., under various conditions of humidity. Air permeability results obtained with ethyl cellulose, regenerated cellulose, cellulose acetate, vinylidene chloride, polyvinyl alcohol and Glassine are tabulated. In dry air the rate of transmission at 36.7° C. is more than double that at 1° C. A rise in humidity decreases the rate for ethyl cellulose, but increases it for regenerated cellulose.

J. G.

Creasing of Paper for Water Vapour Permeability Tests. Anon. (*Paper Trade J.*, 1944,

118, 9th Mar., *T.A.P.P.I. Sect.*, 81)—In testing paper for food packaging for resistance to water vapour it is important to take the effects of creasing into account, and the following standard method (*T.A.P.P.I.* T465, sm-44) is suggested for ensuring that a standard type of crease is made. Cut a square specimen (area, 60 to 133 cm²), and condition it in the usual way. Make a series of creases along straight lines parallel to one edge at 0.75 in. intervals, folding each face of the paper alternately, so as to produce a camera bellows effect; unfold each crease before making the next. Repeat these operations so as to obtain another set of similar creases at right angles to the first set. Cut a specimen of suitable size from the creased sheet, and test it in the usual way (*cf. ANALYST*, 1944, 69, 197). To ensure a standard creasing procedure, first make a preliminary light crease in the paper with a flat strip of wood or metal on a flat metal or glass plate of suitable dimensions. Then complete the crease by lowering on to it, gently, a suitably loaded square metal or glass plate, whose length is *ca.* 0.5 in. greater than that of the specimen to be creased, and whose wt. in kg equals the length in cm of the specimen.

J. G.

Reviews

DICTIONARY OF ORGANIC COMPOUNDS. I. M. HEILBRON and H. M. BUNBURY. Vols. II and III. Pp. viii + 891; viii + 977. London: Eyre & Spottiswoode, Ltd., 1944. Price £6 6s. 0d. per vol.

Volume I of this well-known dictionary first appeared in 1932 and last year a fully revised and enlarged second edition was published.

It has not been found possible, however, owing to war conditions, to re-write or even to revise Volumes II and III, which first appeared in 1936 and 1937 respectively, but, these volumes being out of print, the authors and publishers have done the next best thing—they have reprinted them with the addition of supplements containing references to recent work and the inclusion of some older references which were obvious omissions from the first edition. The new edition of Vol. I contains cross-references to the compounds appearing in the supplements to Volume II (33 pp.) and to Volume III (42 pp.). As far as possible, the literature has been surveyed to the end of 1940, and many references to important papers appearing in 1941 and 1942 have been included. The wise policy of giving detailed references to compounds of biochemical and chemotherapeutic interest has been continued, and users of these new volumes will be saved much time in their search into the recent literature of organic chemistry. The cutting down of the liberal margins of pages has resulted in volumes of a more convenient size without sacrificing the bold print and clear arrangement which was so pleasant a feature of the first edition.

J. KENYON

WAR-TIME INFORMATION FOR PHARMACISTS. Compiled by The Pharmaceutical Journal (with the assistance of J. A. STEWART, B.Sc., B.L., Ph.C., Barrister-at-law). 3rd Ed. Pp. 80. London: The Pharmaceutical Press, 1944. Price 1s. 6d.

This useful booklet has been considerably extended from the previous edition, eighty new sections having been included, while one hundred and twenty-nine have been revised. Acts of Parliament, Defence Regulations and Statutory Rules and Orders of direct or indirect interest to the pharmacist (and also to the analyst) are summarised, all those issued prior to March 31st, 1944, being mentioned. The sections are arranged in alphabetical order and in addition to more specialised topics such as the various control orders, Economies in Prescribing, Examinations, Surgical Spirit, etc., many of wider application are included. Among these may be mentioned Enemy Patents and Trade Marks, Glycerin Substitutes, Treatment of Phosphorus Burns, Income Tax, British Standard Specifications, Lighting Restrictions,

Black-out Times, Rents, Dealings in Typewriters and many others. As in the 2nd Edition, a useful list of addresses is given at the end of the booklet, comprising Government Departments, trade and research associations and professional and scientific societies.

The compilers have succeeded in producing an admirably concise work of reference, the value of which to all whose work is connected with drugs is far greater than might be indicated by its modest price.

JOHN ALLEN

INAUGURAL MEETING OF THE MICROCHEMICAL GROUP

IN view of the present uncertain conditions and of the extreme difficulties of travelling long distances, the Council has decided to postpone the inaugural meeting of the Microchemical Group until the day of the Ordinary Meeting of the Society in October. Members of the Group will receive notification of the meeting in due course.

PROPOSED FORMATION OF A GROUP DEALING WITH PHYSICAL METHODS OF ANALYSIS

IN pursuance of the policy for the formation of Groups for special branches of analytical chemistry proposed by the Council and approved by a meeting of the Society on November 3rd, 1943, the Council has had under consideration a proposal to form a Group dealing with physical methods of analysis. The Group would deal with such methods as for example:

1. Spectrographic methods
 - (a) Emission spectrograph;
 - (b) U.V. and visible absorption spectrograph;
 - (c) Infra-red absorption spectrograph;
 - (d) Mass spectrograph.
2. Quantitative photometric methods by means other than spectrophotometry.
3. Polarographic methods.
4. X-Ray diffraction.

The Council's decision as to the formation of the Group will depend on the number of members of the Society desirous of joining it. Members of the Society who wish to become members of the Group are asked to notify the Hon. Secretary of the Society, 7/8, Idol Lane, London, E.C.3.

Society of Public Analysts and Other Analytical Chemists

ANALYTICAL METHODS COMMITTEE

The following Reports may be obtained direct from the Editor of *THE ANALYST*, The Close, Weedon, Aylesbury, Bucks. (not through Trade Agents), at the price of 1s. 6d. each to Members of the Society, 2s. each to non-Members. Remittance must accompany the order, and be made payable to "The Society of Public Analysts."

The Reichert-Polenske-Kirschner Process. *One Report.*

Sub-Committee on Dirt in Milk. *One Report*

Milk Products Sub-Committee. *Four Reports.*—(1) and (2) Analysis of Condensed Milks. (3) Analysis of Sweetened Condensed Milk, etc. (4) Determination of Water, of Total Solids and of Fat in Dried Milk.

Essential Oil Sub-Committee. *Thirteen Reports.*—(1) Estimation of Cineole in (a) Cajuput and Eucalyptus Oils. (2) and (3) Physical Constants. (4) Acetylisable Constants in Essential Oils. (5) Phenols in Essential Oils. (6) Citral in Lemon Oil. (7) Determination of Solubilities. (8) Cineole in (b) Camphor Oil and (c) Other Oils. (9) Carvone and Menthone. (10) Citronellal. (11) Aldehydes other than Citronellal. (12) Ascaridole. (13) Determination of Esters.

Sub-Committee on the Determination of Arsenic, Lead, etc. *Three Reports.*—(1) Arsenic. (2) Lead. (3) Copper.

Sub-Committee on the Determination of Unsaponifiable Matter in Oils and Fats and of Unsaponified Fat in Soap. *Five Reports.*—(1) Unsaponifiable Matter in Oils and Fats. (2) Unsaponified Fat in Soap. (3) Free Alkali in Soaps. (4) Free Alkali and Silica in Silicated Soaps. (5) Rosin in Soaps.

Poisons Sub-Committee. *Three Reports.*—(1) Assay of Lobelia. (2) Assay of Gelsemium. (3) Assay of Aconite.

Spectrophotometric Terms and Symbols. *One Report.*

Also:—**Bibliography of Heavy Metals in Food & Biological Material (1929-1933).** Price: Members 2s; Non-Members 3s. prepaid.

SPECIALLY CALIBRATED THERMOMETERS

We doubt if it is appreciated just how good our ordinary thermometers are. All our engraved ones are Nitrogen filled under pressure and are annealed in varying temperatures for at least three weeks.

We hold large stocks for immediate delivery and in general, although they are quite as cheap as most other makes, the accuracy can be expected to be within half a division. You may get an occasional one which might have an error of twice this, but that is about the worst you should get.

To meet a special demand, however, we stock another range which deserves to be much better known. This is

"Specially Calibrated"

and these words are marked on every thermometer. In this type an extra check has been done on all calibrations, and the accuracy is so good that they are intended for checking ordinary thermometers.

The price, however, is not particularly high.



— FOR — *"Service to Science"*

TOWNSON & MERCER LTD

390 SYDENHAM ROAD

CROYDON

Telephone: THORnton Heath 3851 (5 lines)

Telegrams: Townson, Croydon

Contents

PROCEEDINGS OF THE SOCIETY OF PUBLIC ANALYSTS AND OTHER ANALYTICAL CHEMISTS		PAGE
The Hypophosphorous Acid Reduction of Tin. An Improved Procedure and Notes on its Mechanism— B. S. Evans, M.C., M.B.E., D.Sc., F.R.I.C., and D. G. Higgs		201
The Rapid Photometric Determination of Tellurium in Tellurium Copper Alloys—P. B. Crossley, F.R.I.C.		206
Manganous Sulphate as Catalyst in the Cerimetric Determination of Serum Calcium—V. R. Wheatley ..		207
Daily Variations in the Freezing-point Depressions of Cows' Milk—Arnold R. Tankard, F.R.I.C., and D. J. T. Bagnall, A.C.G.F.C., F.R.I.C.		209
Notes—The Analysis of Vulcanised Rubber, with Special Reference to Synthetic Materials; A Vacuum- operated Micro-stirrer		211
Home Office—Provisional and Statutory Rules and Orders		214
Ministry of Food—Statutory Rules and Orders; Standard for Shredded Suet		214
Legal Notes		215
The British Pharmacopoeia, 1932		216
ABSTRACTS OF PAPERS PUBLISHED IN OTHER JOURNALS		
Food and Drugs—		
DETECTION OF DECOMPOSITION IN LIQUID, FROZEN AND DRIED EGGS—H. A. LEPPER, M. T. BARTRAM AND F. HILLIG		216
PERSISTENCE OF MONOCHLOROACETIC ACID IN FRUIT JUICES AND CARBONATED BEVERAGES—J. B. WILSON CONDITIONS FOR COMPLETE ACID INVERSION IN ANALYSIS OF FINAL CANE MOLASSES—F. W. ZERBAN, J. E. MULL AND J. MARTIN		217
MOISTURE IN POTATO STARCH—W. L. PORTER AND C. O. WILLITS		217
FANWEED SEED OIL—J. R. CLOPTON AND H. O. TRIEBOLD		218
EFFECT OF RELATIVE HUMIDITY ON THE DETERMINATION OF OIL IN SOYA BEANS—O. A. KROBER AND F. I. COLLINS		218
Biochemical—		
ACCURACY OF HAEMOGLOBIN METHODS—E. J. KING, M. GILCHRIST AND G. E. DELORY		219
METHOD FOR THE DETERMINATION OF COPROPORPHYRIN IN URINE—H. L. MASON AND S. NESBITT		219
NICOTINIC ACID AND RIBOFLAVIN IN BEEF EXTRACTS AND CORNED BEEF—R. G. BOOTH AND E. C. BARTON- WRIGHT		219
NEW TEST FOR ACETONE—J. INGRAM		220
ASCORBIC ACID AND HIP FERTILITY IN ROSA SPECIES—J. W. H. HARRISON AND G. A. D. JACKSON		220
ASCORBIC ACID AND HIP FERTILITY IN ROSA SPECIES—A. GUSTAFSSON AND J. SCHRODERHEIM		220
ASCORBIC ACID AND HIP FERTILITY IN ROSA SPECIES—R. MELVILLE		221
THIOUREA AS PROTECTIVE AGENT FOR VITAMIN C—E. KAWEREAU AND W. R. FEARON		221
ROLE OF PHOSPHATE IN THE METHYLENE BLUE REDUCTION BY DEHYDROASCORBIC ACID—L. FRANKENTHAL DETERMINATION OF ASCORBIC ACID IN PRESENCE OF INTERFERING SUBSTANCES, NOTABLY REDUCTONES— L. F. LEVY		222
Bacteriological—		
EFFECT OF INCREASE IN ACIDITY ON ANTISEPTIC EFFICIENCY—O. RAHN AND J. E. CORM		222
Water—		
TESTS FOR ACTIVE RESIDUAL CHLORINE AND CHLORAMINE IN WATER—F. J. HALLINAN		222
Organic—		
APPLICATION OF THE FERRIC THIOCYANATE METHOD TO THE DETERMINATION OF INCIPIENT RANCIDITY IN FATS AND OILS—A. LIPS, R. A. CHAPMAN AND W. D. MCFARLANE		222
ANTIOXIDANT PROPERTIES OF NORDIHYDROGUAIARETIC ACID—W. O. LUNDBERG, H. O. HALVORSON AND G. O. BURR		223
MODIFIED KREIS TEST APPLICABLE TO COSMETIC PREPARATIONS—J. H. JONES		223
Inorganic—		
NOMENCLATURE OF ALLOYS		223
ANALYSIS OF CYANIDE BRASS ELECTROPLATING SOLUTIONS—S. G. CLARKE, W. N. BRADSHAW AND E. E. LONGHURST		223
ELECTROLYTIC DETERMINATION OF COPPER IN CAST IRON AND STEEL—W. S. LEVINE AND H. SEAMAN		224
DETERMINATION OF SMALL AMOUNTS OF MOLYBDENUM IN PLANTS AND SOILS—M. L. NICHOLS AND L. H. ROGERS		224
SEPARATION OF MANGANESE FROM OTHER METALS BY PYRIDINE—J. I. WATTERS AND I. M. KOLTHOFF		224
DETERMINATION OF SODIUM IN POTASSIUM HYDROXIDE—D. WILLIAMS AND G. S. HAINES		225
ELIMINATION OF NITRATE IMPURITY FROM HYDROGEN PEROXIDE—E. C. CANTINO		225
Microchemical—		
POTASSIUM ETHYL XANTHATE AS ANALYTICAL REAGENT. SEPARATION OF COPPER FROM NICKEL—P. WENGER, Z. BESSO AND R. DUCKERT		225
MICROSCOPICAL IDENTIFICATION OF SODIUM AND POTASSIUM BY MEANS OF THEIR CRYSTALLINE PICROLONATES— W. V. EISENBERG AND G. L. KEENAN		225
Physiological Methods, Apparatus, etc.—		
USE OF BRIQUETS FOR THE SPECTROGRAPHIC ANALYSIS OF STEEL—R. E. NUSBAUM, D. L. FRY AND J. W. HACKETT		226
SPECTROCHEMICAL ANALYSIS OF METALS WITH THE MULTISOURCE UNIT—M. F. HASLER AND J. W. KEMP		226
APPLICATION OF MULTIPLIER PHOTO-TUBES TO QUANTITATIVE SPECTROCHEMICAL ANALYSIS—E. A. BOETTNER AND G. P. BREWINGTON		226
SPECTROGRAPHIC DETERMINATION OF TRACES OF SODIUM IN PURE ALUMINIUM—F. ROHNER		226
POLAROGRAPHIC DETERMINATION OF COPPER, LEAD AND CADMIUM IN HIGH-PURITY ZINC ALLOYS—E. C. HAWKINS AND H. G. THODE		226
APPARATUS FOR MEASURING GAS TRANSMISSION THROUGH SHEETS AND FILMS—H. R. TODD		226
CREASING OF PAPER FOR WATER VAPOUR PERMEABILITY TESTS—ANON.		227
Reviews		227