

THE ANALYST

The Journal of The Society of Public Analysts and other Analytical Chemists

Publication Committee

Chairman: J. R. NICHOLLS, D.Sc., F.R.I.C.

N. L. ALLPORT, F.R.I.C.
F. W. F. ARNAUD, F.R.I.C.
A. L. BACHARACH, M.A., F.R.I.C.
R. C. CHIRNSIDE, F.R.I.C.
H. E. COX, D.Sc., Ph.D., F.R.I.C.
BERNARD DYER, D.Sc., F.R.I.C.
F. W. EDWARDS, F.R.I.C.
B. S. EVANS, M.B.E., M.C., D.Sc., F.R.I.C.
E. HINKS, M.B.E., B.Sc., F.R.I.C.
E. B. HUGHES, D.Sc., F.R.I.C.

D. W. KENT-JONES, B.Sc., Ph.D., F.R.I.C.
S. ERNEST MELLING, F.R.I.C.
G. W. MONIER-WILLIAMS, O.B.E.,
M.C., Ph.D., F.R.I.C.
A. MORE, I.S.O., A.R.C.S.,
A.R.T.C., F.R.I.C.
W. H. SIMMONS, B.Sc., F.R.I.C.
ERIC VOELCKER, A.R.C.S., F.R.I.C.
K. A. WILLIAMS, B.Sc., F.R.I.C.
G. H. WYATT, B.Sc., Ph.D., F.R.I.C.

Hon. Secretary:

L. EYNON, B.Sc., F.R.I.C.
7-8, Idol Lane, E.C.3

Hon. Treasurer:

G. TAYLOR, F.R.I.C.
Peck House, 20, Eastcheap, E.C.3

Editor: C. AINSWORTH MITCHELL, D.Sc., M.A., F.R.I.C.
The Close, Weedon, Aylesbury, Bucks.

Secretary and Assistant Editor: J. H. LANE, B.Sc., F.R.I.C.
7-8, Idol Lane, E.C.3

Abstractors

S. G. CLARKE, D.Sc., Ph.D., A.R.I.C.
B. S. COOPER, B.Sc., F.Inst.P.
E. B. DAW, B.Sc., A.R.I.C.
J. GRANT, Ph.D., M.Sc., F.R.I.C.
A. O. JONES, M.A., F.R.I.C.

J. W. MATTHEWS, Ph.D., D.I.C., F.R.I.C.
E. M. POPE, B.A., B.Sc.
F. A. ROBINSON, M.Sc.Tech., F.R.I.C.
W. R. SCHOELLER, Ph.D., F.R.I.C.
D. R. WOOD, F.R.I.C.

Published for the Society by
W. HEFFER & SONS LTD., Cambridge, England

IMPORTANT NOTICE TO SUBSCRIBERS

(Other than Members of the Society).

All Subscriptions and renewals to the Journal should be sent
through a Bookseller or direct to

W. HEFFER & SONS LTD., CAMBRIDGE, ENGLAND.

Price 3/6; or to Subscribers in advance, post free, 35/- per annum.

N.B.—Members send their subscriptions to the Hon. Treasurer.

QUICKFIT DOES IT BETTER—

ANTI-FOAMING SPLASH HEAD

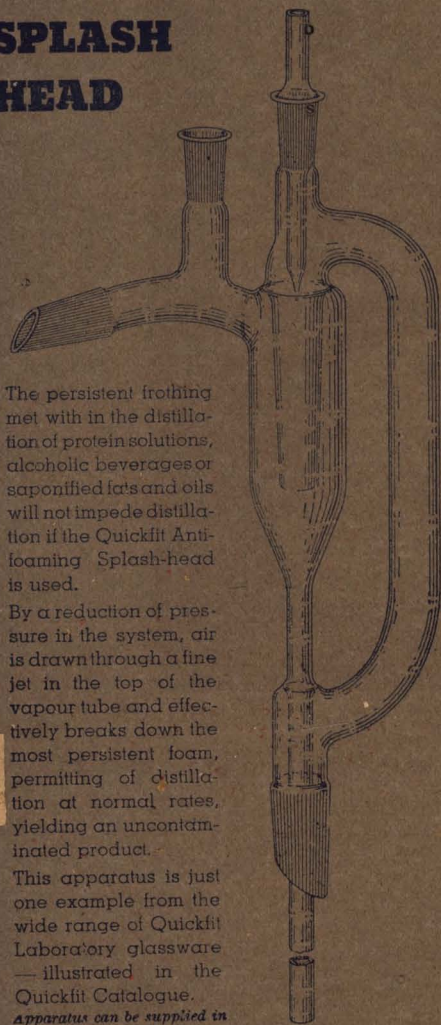

The persistent frothing met with in the distillation of protein solutions, alcoholic beverages or saponified fats and oils will not impede distillation if the Quickfit Anti-foaming Splash-head is used.

By a reduction of pressure in the system, air is drawn through a fine jet in the top of the vapour tube and effectively breaks down the most persistent foam, permitting of distillation at normal rates, yielding an uncontaminated product.

This apparatus is just one example from the wide range of Quickfit Laboratory glassware—illustrated in the Quickfit Catalogue.

Apparatus can be supplied in Pyrex, Phoenix or Huxil glass.

QUICKFIT
LABORATORY GLASSWARE WITH STANDARD
INTERCHANGEABLE GROUND GLASS JOINTS

QUICKFIT & QUARTZ LTD

TRIPLEX WORKS, KING'S NORTON, BIRMINGHAM

London Office: 1 Albemarle Street, W.1

Phone Regent 8171

Prepare your Media with

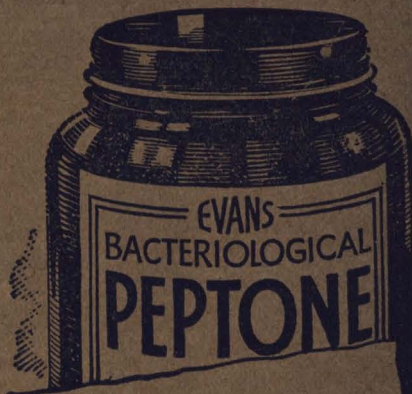

It is free from contaminating organisms and toxic by-products.
It contains no fermentable carbohydrate.

Unlike many of the older peptones it provides in saline solution alone a complete medium for a wide variety of bacteria.

With the addition of dextrose, a saline solution produces an excellent growth of pneumococci, hæmolytic streptococci, and organisms of the coli typhoid and welchii groups.

No serum need be added when it is used for typing streptococci for the fermentation reactions.

It conforms to the requirements of the Indol test.

Potent diphtheria, tetanus, welchii and other toxins can be obtained with media containing this peptone.

It has low copper and iron content.

Bacteriological Peptone (Evans) is issued in 5 and 16-oz. amber bottles with bakelite screw caps

BILE SALTS and other culture media also available.

Prices and full details will be sent on application to:—
Liverpool: Home Medical Dept., Speke, Liverpool, 19
London: Home Medical Dept., Bartholomew Close, E.C.1

MEDICAL EVANS PRODUCTS

Made in England by

EVANS SONS LESCHER & WEBB, LTD.

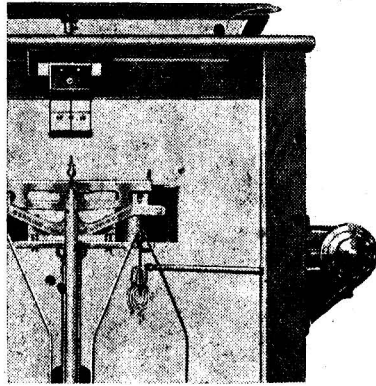

THE FINEST

Quality

IN THE WORLD

Rapid, accurate precision weighing made possible with the "Multi-weight" device.

Oertling design saves Chemists' time!

All fractional weights added automatically and read off from scale graduated in fifths of a mg. without opening the balance case. No loose weights below 1 gram. Capacity 100 grams. Ask for specification 62 FM.

Oertling

NOTE THE ADDRESS:-

TELEPHONE
WELbeck 2273

L. OERTLING LTD.
110 GLOUCESTER PLACE,
LONDON W.1.
(Near BAKER STREET STATION)

FOUNDED
IN LONDON
BEFORE 1847

TAS/OR.223

CALCIUM CARBONATE (LOW IN FLUORINE)

FOR USE IN THE DETERMINATION OF FLUORINE IN FOODS

The procedure recommended in the report of a Sub-Committee of the Analytical Methods Committee of the Society of Public Analysts demands the use of calcium carbonate essentially free from fluorine and of a high degree of purity in other respects (Analyst, 1944, 69, 243). A product specially prepared in order that it may meet these requirements is now available.

Prices: 100 g. 4s. 2d.; 250 g. 9s. 8d.; 500 g. 18s. 9d.

THE BRITISH DRUG HOUSES LTD., LONDON, N.1

We have made available certain Analytical Reagents with ACTUAL BATCH ANALYSIS confirmed by INDEPENDENT Analysts of the highest standing: particulars of one example are given.

★ YOU ARE INVITED TO COMPARE THE PURITY WITH THAT GUARANTEED BY ANY COMPETING MAKER.

JUDACTAN ANALYTICAL REAGENT

SODIUM HYDROXIDE A.R.
Na.OH Mol. Wt. 40.005

ACTUAL BATCH ANALYSIS
(Not merely maximum impurity values)

Batch No. 21631	
Chloride (Cl)	0.005%
Nitrate (NO ₃)	0.001%
Phosphate (PO ₄)	0.001%
Silicate (SiO ₂)	0.001%
Sulphate (SO ₄)	0.0025%
Heavy Metals (Pb)	0.00025%
Iron (Fe)	0.0015%
Aluminium (Al)	0.002%
Ammonia (NH ₃)	0.0002%
Arsenic (As ₂ O ₃)	0.6 p.p.m.

The above analysis is based on the results, not of our own Control Laboratories alone, but also on the confirmatory Analytical Certificate issued by independent Consultants of international repute

The General Chemical & Pharmaceutical Co., Ltd.
Chemical Manufacturers, Judex Works, Sudbury, Middlesex

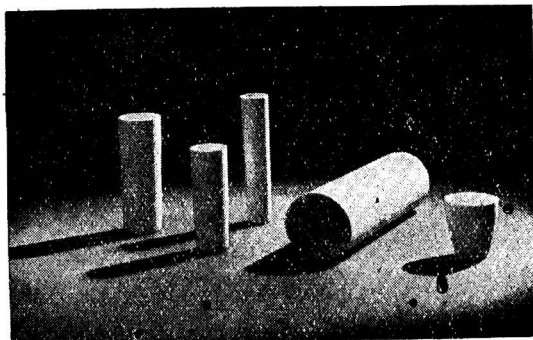

POROUS ALUMINA WARE.

Crucibles and thimbles for filtration with subsequent ignition, are available in limited range of sizes, replacing vessels formerly imported.

The Thermal Syndicate Ltd.

• Head Office:
WALLESEND, NORTHUMBERLAND

London Depot:

12-14, Old Pye St., Westminster, S.W.1

THE ANALYST

PROCEEDINGS OF THE SOCIETY OF PUBLIC ANALYSTS AND OTHER ANALYTICAL CHEMISTS

INAUGURAL MEETING OF THE MICROCHEMICAL GROUP

THIS was held at the Chemical Society's Rooms, Burlington House, Piccadilly, London, W.1, at 2.15 p.m. on Wednesday, October 4th, 1944. The President of the Society, Mr. S. E. Melling, was in the chair.

Professor H. V. A. Briscoe was elected Chairman of the Group, and took over the chair from the President. The following other officers were then elected—*Vice-Chairman*, Mr. N. Strafford. *Hon. Secretary*, Mr. R. Belcher.* *Committee*, Dr. J. G. A. Griffiths, Miss I. Hadfield, Dr. J. W. Matthews, Mr. C. Whalley, Dr. C. L. Wilson, Dr. G. H. Wyatt.

The Chairman having invited the meeting to offer suggestions for topics for lectures and suitable centres to hold meetings, the President stated that a meeting in Manchester would be welcomed and this was endorsed by the Chairman of the North of England Section. The desirability of holding joint meetings with other societies was pointed out by several members. Arrangements for meetings were left in the hands of the officers.

Miss Hadfield reminded members that the journal *Mikrochemie* was available to all Group members. The meeting adopted a suggestion of Dr. C. A. Mitchell that the permission of the Chemical Society should be asked to have shelves in the Society's Library to house *Mikrochemie* so that the journal should be available to the Chemical Society as well as to the Group. It was agreed that the journal should be available on loan to Group members only.

Miss Hadfield asked if it would be possible to run the Bibliography service as was done by the Microchemical Club before the war. The President stated that this would be a matter for the Council to decide, and at the same time he would ask if it were ready to sanction the continued purchase of *Mikrochemie*.

Dr. Janet W. Matthews then delivered an address on "The Development of Micro Methods in Analytical Chemistry," the meeting being opened to members of the Society generally. Dr. Matthews described the early work of Behrens in 1880 and the development of chemical microscopy work, extended at a later date by Chamot and Mason. This was followed by Emich's work—begun about 1900—which placed microchemistry on a quantitative basis, using the torsion balance. Emich also devised many ingenious pieces of apparatus, notably the filter stick. [Some of these were illustrated by slides.] About 1910 Pregl attempted to develop methods for the ultimate analysis of organic compounds and, since the torsion balance was not suitable for use with the heavier weights involved, he persuaded Kuhlmann to devise his now well-known balance. Feigl had placed spot-tests on a systematic basis, and had been responsible for the development of many new ones. Dr. Matthews mentioned incidentally that Feigl had now established a school in Brazil after escaping from the Continent in 1940. Dr. Matthews concluded her address by saying that only after the war would it be appreciated to what extent the use of micro methods had spread in this country.

The Chairman thanked Dr. Matthews for her admirable address. He said that since the application of microchemical methods was a craft in addition to a science, it appealed to the scientist because it gave him an opportunity to exhibit his skill as a craftsman.

The meeting of the Microchemical Group then closed, and was followed immediately by a short

ORDINARY MEETING OF THE SOCIETY

under the chairmanship of the President, at which a paper on "The Micro-determination of Carbon by Wet Combustion," by A. A. Houghton, B.Sc., Ph.D., F.R.I.C., was read and discussed.

* Address: 85, Bannerdale Road, Sheffield, 7.

NORTH OF ENGLAND SECTION

A MEETING of the Section was held in Leeds on Saturday, April 15th, 1944.

The Chairman (W. Gordon Carey) presided over an attendance of 27. The following papers were read and discussed:—"The National Milk Testing Scheme," by C. A. Scarlett, B.Sc., A.K.C., F.R.I.C.; "Barley Sugar," by H. M. Mason, M.Sc., F.R.I.C.

NEW MEMBERS OF THE SOCIETY

Arthur Edgar Beet, B.Me^l. (Sheff.); Norman Cecil Chandler, A.R.I.C.; Max Klein, Major, I.M.S., M.D. (Leipzig); George Howard Osborn; Charles Howard Price, B.Sc. (Lond.), A.R.I.C.; Thomas Alexander Thomson, B.Sc. (N.Z.), A.N.Z.I.C.

DEATHS

We regret to record the deaths of George William Clough, Frederick Alan Dawson and Thomas Swinden.

Some Experiences of Microbiological Assays of Riboflavin, Nicotinic Acid and other Nutrient Factors

BY D. W. KENT-JONES, PH.D., B.Sc., F.R.I.C., AND M. MEIKLEJOHN

(Read at the Meeting, November 1, 1944)

MANY analysts now have experience of the chemical determination of vitamin B₁ (aneurine or thiamine) by the thiochrome reaction, such as is used in the methods of Nicholls, Booth, Kent-Jones, Amos and Ward¹ and The Vitamin B₁ Sub-Committee of the Accessory Food Factors Committee of the Medical Research Council and the Lister Institute,² which methods were the outcome of earlier papers on this subject by numerous investigators. Relatively few, however, have so far attempted assays of other members of the B group, such as riboflavin and nicotinic acid, so that it was thought that a record of our own experiences in this field might be of value to fellow analysts, although we make no claim to have done original research work.

Our work in the first instance was concerned with cereals, and with products of this type the chemical methods, such as that of Najjar,³ which has been advocated for the determination of riboflavin, and that of Kodicek⁴ for nicotinic acid, failed to give us satisfactory results. We therefore turned to the microbiological methods.

The literature, all quite recent, revealed a number of alternative methods; hence we felt it desirable to sort out what was apparently useful from that which was, to say the least, superfluous. In this connection we wish to acknowledge the help and guidance we received from Dr. Barton-Wright of the Cereals Research Station of the Ministry of Food, St. Albans, on whose published work we have drawn copiously, and who piloted us through a sea which was then indifferently charted. We felt that the time had arrived when the subject could be profitably surveyed by the practising analyst as opposed to the wholtime research worker, especially in view of the Labelling Order, S.R. & O., 1944, No. 738.

It may be of interest to analysts to recall the basic principles involved in microbiological assays of vitamins. In the early days of vitamin assays it was customary to make these by undertaking feeding tests, usually on young rats or guinea pigs; the experimental animals were fed on a specially purified basal diet which provided for all their nutritional requirements save that of the vitamin being investigated. Nevertheless, although this basal diet provided all the necessary calories, proteins, minerals and the other vitamins, the experimental animals failed to grow and gain weight until there was a sufficient addendum of the missing vitamin. By comparing growth rate, when known amounts of the required vitamin were added, with the growth rate when known quantities of a particular food were added, it was possible to deduce the vitamin content of the food in question. This method, however, was only satisfactory in the hands of experienced workers, the procedure was lengthy and expensive and, furthermore, unless a comparatively large number of specially selected experimental

animals were used (at least a dozen), the results were open to doubt from the statistical angle. The modern microbiological methods are based upon the fact that selected bacteria are as sensitive to lack of certain vitamins as are rats. If, therefore, these bacteria are provided with a basal medium which contains everything they require save the particular vitamin in question, there is, on incubation, practically no growth, but appreciable growth takes place when the vitamin is added and, furthermore, the rate of growth is directly related to the amount of vitamin present; the extent of growth may be measured by the acidity produced. Such microbiological methods have the advantage that it is thus possible to use millions of "experimental animals" and, furthermore, the test can be made in only a few hours (48-72 for example) instead of several weeks; hence it is suitable for the practising analyst. It is perhaps worth while recalling that the necessity for the presence of vitamins for the growth of such lowly organisms as bacteria does suggest the fundamental nature of the functions of the group of bodies known as vitamins. One point must be emphasised, namely, that the stock culture kept for these tests must be grown in medium rich in the vitamins being assayed, so that it does not become acclimatised to lack of the vitamin and hence grow in medium lacking the vitamin. In absence of the vitamin the blank must be low, and the response when the vitamin is added must be appreciable and, of course, related to the quantity of the vitamin present.

MICROBIOLOGICAL ASSAY OF RIBOFLAVIN

The bacterium *Lactobacillus helveticus* (sometimes called *Lactobacillus casei* ϵ) has been found to be a suitable organism for this assay. It is important, however, to employ the correct strain, as all strains are by no means equally satisfactory (Barton-Wright and Booth⁶). It is fortunately not difficult to provide a basal medium which contains everything necessary save the missing vitamin, *i.e.*, the riboflavin, since it is comparatively easy to eliminate by means of light and other methods any riboflavin present in any of the ingredients. The main components of the basal medium are peptone (treated with sodium hydroxide and photolysed), cystine hydrochloride, yeast supplement, glucose and inorganic salts.

The principal papers on this method are those of Snell and Strong,⁵ Barton-Wright and Booth⁶ and Strong and Carpenter.⁷ The technique which we have found to be the most satisfactory embodies procedures recommended in each of these papers and we, therefore, give below full details of the technique we employ.

METHOD—The stock culture of *Lactobacillus helveticus* is maintained as a stab culture in a solid yeast-glucose-agar medium which contains all the essential growth factors for this organism and is certainly rich in riboflavin. Once each month three fresh stab cultures in the same medium are prepared from a stock culture and, after being incubated for 24 hr. at 37° C., are stored in the refrigerator. One of these stabs is reserved as the stock culture for making the transfers for the next month's cultures, and the other two are held available during the month for the preparation of inocula required for assays. When an inoculum is required, organisms from one of these two reserved tubes are transferred to a tube of basal medium containing between 0.5 and 1.0 μg of riboflavin and incubated for 24 hr. at 37° C. The cells are then centrifuged out aseptically and re-suspended in twice their volume of sterile 0.9% sodium chloride solution. This suspension serves as the inoculum for the tubes employed in an assay. Each foodstuff tested requires 6 tubes, but each batch of assays includes an additional 10 tubes for the construction of a standard curve; all the tubes contain initially 5 ml of basal medium. To the 6 tubes used in each assay are added suitable aliquots of the extract of the food (for preparation see later) so that they represent 3 levels in duplicate of riboflavin concn. These levels should lie between 0.05 and 0.20 μg of riboflavin per tube, a range in which the acid production is proportional to the riboflavin concn. To 8 of the tubes required for the construction of the standard curve are added volumes of standard riboflavin soln. to give duplicate tubes at the levels of 0.05, 0.10, 0.15 and 0.20 μg of riboflavin per tube, while the remaining 2 of these 10 tubes are blanks and have no riboflavin added. All tubes (those for the standard curve and those containing the food extract) are made up to 10 ml with distilled water. The tubes are protected from contamination, and this is most conveniently done by inverting over them loosely fitting glass, specimen tubes. The tubes are then sterilised for 15 min. at 15 lb. pressure. After autoclaving,* 2 drops of the inoculum described above are added to each tube and the tubes are then incubated at 37° C. for 72 hrs. At the

* Note. While cooling, *i.e.*, before addition of the inoculum, the tubes should be protected from light.

end of this incubation the acidity of each tube is titrated on the lines indicated by Barton-Wright and Booth.⁶ We actually use a 4-tube comparator and the arrangement of the 4 tubes is as follows: A B
C D

Tube A contains 20 ml of distilled water and Tube B 20 ml of buffer soln. (50 ml of 0.2 M KH_2PO_4 , and 23.65 ml of 0.2 N NaOH, diluted to 200 ml) and 20 drops of bromothymol blue indicator (0.04% aq. soln.). Tubes C and D are two of the assay tubes. To Tube C are added 10 drops of the indicator and the contents are then titrated with standard alkali, such as N/10 or N/14 sodium hydroxide, and for every ml or part of a ml of standard alkali added an extra drop of indicator is also added. The titration is completed when the colours seen through C and D exactly match. Averages are taken for the titration values of each pair of duplicate tubes. It is sufficient merely to add to Tube D the requisite amount of indicator and then to titrate it until it matches Tube C as judged by direct comparison. Each pair of tubes can be treated in this way and thus the comparator used only for alternate tubes. From the tubes containing added riboflavin soln., figures are obtained and plotted against the corresponding riboflavin contents of the tubes and this constitutes the standard curve for the assay in question. Within the range of concns. employed the curve is a straight line. By means of this curve the average titration values of the duplicate pairs of tubes containing added extract of the food can be translated into riboflavin content. The values thus obtained at the three levels should be reasonably close (within $\pm 10\%$) and can be averaged for the final figure.

EXTRACTION OF RIBOFLAVIN FROM FOODS—In general, we follow the procedure laid down by Strong and Carpenter,⁷ and on samples which do not contain starch or fat a direct procedure may be employed as follows.

The weighed sample is suspended in 50 ml of 0.1 N hydrochloric acid, the suspension is autoclaved for 15 min. at 15 lb. per square inch, cooled, adjusted to pH 6.8 with 0.5 N sodium hydroxide (using bromothymol blue externally) and diluted to give a concn. of riboflavin between 0.1 and 0.02 μg per ml. Aliquots are added to the assay tubes of basal medium.

With cereals we have found it essential to hydrolyse the starch with acid and remove fat-soluble interfering substances. The removal of interfering substances can be accomplished in most cases by careful filtration as follows. To the autoclaved suspension, obtained as above, containing about 10 μg of riboflavin, are added 2 ml of 2.5 N sodium acetate and 0.5 N sodium hydroxide, until the pH is 4.5 (bromophenol blue used as external indicator). The volume is made up to 100 ml. The mixture is filtered through a good-quality fluted filter paper. A 50-ml aliquot of the filtrate is adjusted to pH 6.8 (bromothymol blue in 0.02% aq. soln. used as external indicator), and diluted to 100 ml for the assay.

With fatty materials, such as germ, meat diets, fish meals, etc., the sample is dried, if necessary, finely ground and extracted with light petroleum. The sample is autoclaved in the usual manner with 50 ml of 0.1 N hydrochloric acid, the pH is adjusted to 4.5 with sodium acetate and sodium hydroxide, the volume is made up to 100 ml, and a 50-ml aliquot is shaken out with two portions of ether of approximately 30 ml. The ether is washed with water, and the combined aqueous phase and washings are adjusted to pH 6.8 and diluted to 100 ml. Aliquots are directly added to the assay tubes.

When the extract is taken from the autoclave and during the period in which adjustment of the pH is made either direct to 6.8 or *via* the 4.5 stage, it is necessary to protect from light. In actual practice we work in a dark room with a red lamp at this stage.

In dealing with foods of which the range of riboflavin content is not known, it is essential to do some preliminary assays on the lines indicated in order to know how much extract will contain amounts of riboflavin within the tube range of 0.05–0.2 μg .

PREPARATION OF MEDIA AND REAGENTS—*Photolysed Sodium Hydroxide Treated Peptone*—A mixture of 40 g of peptone (Difco Bacto) in 250 ml of water and 20 g of sodium hydroxide in 250 ml of water is exposed in a 25-cm crystallising dish to light from a 100-watt incandescent lamp with reflector at a distance of approx. 30 cm. for 6 to 10 hr., and is then allowed to stand for an additional 18 to 14 hr. (24 hr. in all). The sodium hydroxide is neutralised with glacial acetic acid (27.9 ml) and 11.6 g of hydrated sodium acetate are added. The mixture is diluted to 800 ml and preserved under toluene in the refrigerator.

The above treatment destroys other substances, besides riboflavin, essential for growth of the assay organism, but these are supplied in the yeast supplement.

Yeast Supplement—To a solution of 100 g of Bacto yeast (Difco) in 500 ml of water, add 150 g of basic lead acetate dissolved in 500 ml of water and filter off the ppt. Add ammonium

hydroxide to the filtrate to reach a pH of about 10.0 and again filter off the ppt. formed. Just acidify the filtrate with glacial acetic acid, ppt. the excess of lead with hydrogen sulphide and filter off and discard the lead sulphide. All the riboflavin is removed by this treatment. Make up the filtrate to 1000 ml (removal of H₂S unnecessary) and store under toluene in the refrigerator. One ml of this preparation is equiv. to 100 mg of the original yeast extract.

Inorganic Salts—Solution A: 25 g of dipotassium hydrogen phosphate and 25 g of potassium dihydrogen phosphate in 250 ml of water.

Solution B: 10 g of magnesium sulphate heptahydrate, 0.5 g of sodium chloride, 0.5 g of ferrous sulphate heptahydrate and 0.5 g of manganese sulphate tetrahydrate in 250 ml of water.

Cystine—Prepare a soln. of cystine hydrochloride containing 1 mg of cystine per ml and keep under toluene in the refrigerator.

All the above, if kept in the refrigerator, will last many months.

Preparation of the Basal Medium—Mix 50 ml of photolysed sodium-hydroxide-treated peptone soln., 50 ml of cystine hydrochloride soln., 5 ml of yeast supplement, 5 g of glucose, 2.5 ml of soln. A and 2.5 ml of soln. B and adjust the pH to 6.8 with sodium hydroxide,* and dilute the mixture to 250 ml. This provides sufficient basal medium for 50 tubes (say, three assays) and is made up from stock solns. each time.

Standard Riboflavin Solution—For a stock solution, accurately weigh pure riboflavin (Roche Products) and dissolve it in warm acetic acid (0.02 N). A convenient concn. is 10 µg per ml. Keep this soln. in the refrigerator under toluene in a dark bottle, avoiding needless exposure to light, and renew it once every fortnight. For use from day to day, prepare a more dil. soln. containing 0.1 µg of riboflavin per ml from the stock soln.

Stock Cultures—Carry stab cultures of *Lactobacillus helveticus* on a solid medium of yeast water, glucose and agar; this contains all the essential growth factors for this organism and is certainly rich in riboflavin.

Preparation of Yeast-Glucose-Agar: Glucose, 0.5%; agar, 1.5% in yeast water.

Yeast Water—Steam fresh starch-free baker's yeast for 2 hr. with 10 times its weight of water, and then autoclave it for 45 min. at 15 lb. per sq. inch. Allow the cells to settle or, better still, centrifuge them off. Add the glucose and the agar to the yeast water. Autoclave for 15 min. at 15 lb. per sq. inch to dissolve the agar, and adjust the pH to 6.8. Transfer to tubes, plug and autoclave for 15 min. at 15 lb. per sq. in.

TYPICAL RESULT—As an illustration, the result obtained on a custard-type product made with National flour is given. Five g of this product were autoclaved for 15 min. at 15 lb. pressure with 50 ml of 0.1 N hydrochloric acid; 2 ml of 2.5 M sodium acetate were then added, and the pH was adjusted to 4.5 with 0.5 N sodium hydroxide. The solution was made up to 100 ml and filtered, 50 ml of the filtrate were pipetted into a 100-ml flask, the pH was adjusted to 6.8, and the volume made up to 100 ml (external indicators bromophenol blue for the 4.5 stage and bromothymol blue for the 6.8 stage were used). Table I gives the results obtained,

TABLE I—STANDARD CURVE. PART I

Riboflavin µg/tube	..	0.00	0.05	0.10	0.15	0.20
N/14 NaOH, ml	..	1.0 1.1	3.7 3.6	6.1 6.1	8.9 9.0	10.6 10.6
Average	1.05	3.65	6.1	8.95	10.6

FOOD EXTRACT. PART II

Extract ml	N/14 NaOH ml		Average	µg/tube	µg/g
2	3.3	3.4	3.35	0.044	0.88
3	4.4	4.3	4.35	0.064	0.85
4	5.3	5.0	5.15	0.081	0.81

the standard curve Fig. 1 being constructed from the data at the head of the table. It is important to remember the necessity of ensuring that the incubator is uniform in temperature throughout; this point has been emphasised by Price and Graves.⁸

We wish to emphasise certain points. (a) It is necessary to employ normal bacteriological technique. (b) The correct method of extracting the vitamin from the food is essential.

* It is important to re-check the pH after an hour or so to ensure that it is correct at 6.8, especially when a freshly prepared peptone soln. is used.

(c) Destruction of the riboflavin due to the action of light must be avoided. Our expts. suggest that there is likely to be more destruction of riboflavin when the extract is light

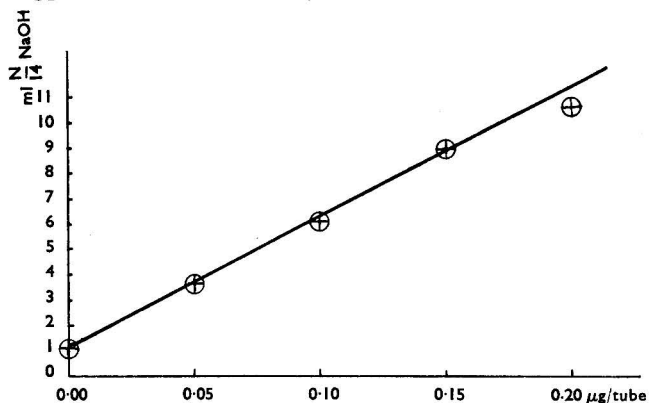

Fig. 1. Riboflavin

coloured. As stated, we believe that it is particularly important to protect the extracts from light when they are hot after leaving the autoclave, and later when the pH is adjusted to 6.8. Working with pure riboflavin and taking no precaution against light, we only obtained a recovery of 50%, but when we were working in a dark room with a red lamp of low wattage the recovery was 92%. (d) The specificity of this test is confirmed by making the assays at different levels; when the assays agree at the different levels, the results can be regarded as

reliable. The levels should be such as to cover the range, *i.e.*, 0.05–0.20 μg/tube.

Table II gives results we have obtained on a series of foods, using the technique described.

TABLE II—RIBOFLAVIN CONTENTS OF VARIOUS FOODS

Commercial (crude) starch (wheaten)	μg/g	0.4
Baker's yeast (70% H ₂ O)	20
Dried yeast (proprietary articles)	40–65
Soya	2.5
National flour	1.1
Meat extract	17.0
Vegetable paste for soup-making	8.5

The recent paper of Macrae, Barton-Wright and Copping⁹ shows that there is good agreement between biological and microbiological assays of riboflavin in food.

MICROBIOLOGICAL ASSAY OF NICOTINIC ACID

The bacterium *Lactobacillus arabinosus* is used for assaying nicotinic acid. The principal papers giving information on the assay in foods, etc., are those of Snell and Wright,¹⁰ who outlined the general method, Krehl, Strong and Elvehjem,¹¹ and Barton-Wright,¹² who made certain amendments in procedure. Since we follow the method of Barton-Wright substantially as described, we have not felt it necessary to give details of the method and content ourselves with a few general observations.

There is one main difference in dealing with the assaying of nicotinic acid, namely, that the basal medium has to be a synthetic one which necessarily has to contain a large number of constituents that are essential to permit growth of the organism. It is not possible to use a reasonably simple medium, such as is used for riboflavin, since it is impossible to free such a medium from nicotinic acid. Hence the basal medium for assaying nicotinic acid involves the use of traces of various vitamins and comparatively rare amino acids.

The *Lactobacillus arabinosus* is kept as stab cultures in the same yeast-glucose-agar medium as is used for riboflavin and, in preparing the inoculum, the procedure and medium are also exactly the same as for riboflavin.

The basal medium is practically that described by Barton-Wright,¹² and is made up accordingly; 5 ml of the solution of the mixed constituents are taken and diluted, where necessary, as in the riboflavin assay, with distilled water to 10 ml so that the final medium has the following composition.

Acid hydrolysed casein	%	0.5	Xylose	%	0.1
<i>dl</i> -Tryptophan	0.02	Sodium acetate (anhydrous)	2.0
<i>l</i> -Cystine	0.02	Sodium chloride	0.5
Glucose (anhydrous)	2.0	Ammonium sulphate	0.3
Calcium <i>d</i> -pantothenate	p.p.m.	0.1	Biotin	p.p.m.	0.0004
Aneurine	0.1	Adenine	10.0
Pyridoxine	0.1	Guanine	10.0
Riboflavin	0.2	Uracil	10.0
<i>p</i> -Aminobenzoic acid	0.1					

Inorganic salts:				%
KH ₂ PO ₄	0.05
K ₂ HPO ₄	0.05
MgSO ₄ · 7H ₂ O	0.02
FeCl ₃	0.00006 (0.6 p.p.m.)
MnSO ₄ · 4H ₂ O	0.0001 (1.0 p.p.m.)

Some workers prefer 1.0% of casein, and there is now available a solid vitamin-free casein hydrolysate which gives good results at 0.6%.

The various stock solutions are kept under a thin layer of toluene and are stored in a refrigerator.

It is necessary to stress some of the points already mentioned by Barton-Wright.¹² Purification of the casein hydrolysate is essential and this we do by the method described by Barton-Wright, although we use barium hydroxide to neutralise the sulphuric acid and also do not make a preliminary treatment with alkali and acid. The biotin used must be free from nicotinic acid and, if the only pure supply is the methyl ester, this must be hydrolysed before use.

We have not experienced any difficulties in extracting the nicotinic acid from foods. In general, about 1-5 g of the food is suspended in 50 ml of *N* hydrochloric acid and autoclaved for 20 min. at 15 lb. pressure.

One point worthy of attention is that, in the final sterilisation of the basal medium and the food extract before inoculation, we use 10 lb. pressure for 10-15 min. and not 15 lb. pressure. The lower pressure is sufficient, and higher pressures tend to darken the liquid and thus render difficult the subsequent titration after incubation.

TYPICAL RESULT—As an illustration the result obtained on a proprietary meat extract is given in Table III and in Fig. 2. In this test 1 g of the product was autoclaved with 50 ml

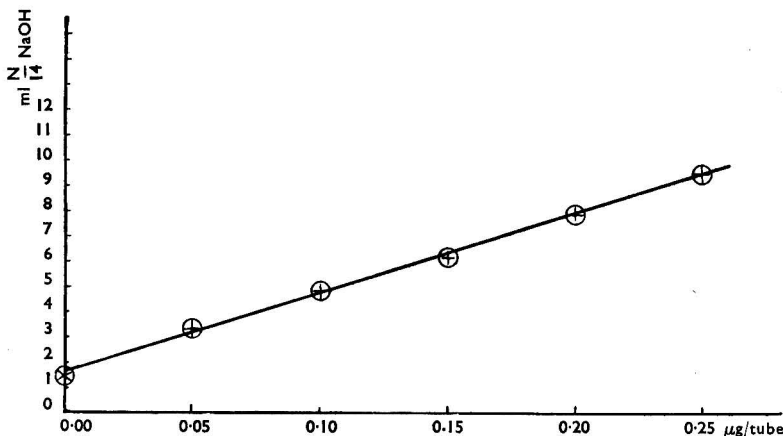

Fig. 2. Nicotinic Acid

of *N* hydrochloride acid for 20 min. at 15 lb. pressure, the pH was adjusted to 6.8 with sodium hydroxide, and the soln. was made up to 500 ml. Then 10 ml were diluted to 100 ml.

TABLE III—STANDARD CURVE: PART I

Nicotinic acid, µg/tube ..	0.00	0.05	0.10	0.15	0.20	0.25						
N/14 NaOH, ml ..	1.5	1.4	3.5	3.2	5.0	4.7	6.2	6.1	8.0	7.7	9.4	9.5
Average	1.45	3.35	4.85	6.15	7.85	9.45				

FOOD EXTRACT. PART II

Extract ml	N/14 NaOH ml		Average	µg/tube	µg/g
1.0	4.9	4.8	4.85	0.100	500
1.5	6.3	6.5	6.4	0.154	513
2.0	7.7	7.7	7.7	0.196	490

Table IV gives some results we have obtained by the use of this method, which has always worked very well and given excellent duplicates. In fact, we have had, if anything, less difficulty with nicotinic acid than with riboflavin assays.

TABLE IV—NICOTINIC ACID CONTENTS OF VARIOUS FOODS

	$\mu\text{g/g}$		$\mu\text{g/g}$
National flour (85% extraction) ..	17.8	Whole wheat	69.0
Another National flour (85% extraction)	16.3	Dried yeast	350.0
White flour (ash 0.45%)	7.6	Baker's yeast (wet basis) ..	115
Lower grade white flour (ash 0.58%)	12.6	Meat extract	500

We have tested out this method from the point of view of recovery and find this is satisfactory, varying from 95% to 105%.

MICROBIOLOGICAL ASSAY OF OTHER VITAMINS AND AMINO ACIDS

Before we leave this subject, reference should be made to the possibilities of assaying other vitamins and amino acids by this procedure. With respect to amino acids, there are many papers, *e.g.*, by Shankman, Dunn and Rubin¹³; Shankman¹⁴; Shankman, Dunn and Rubin¹⁵; Hegsted¹⁶; and Hutchings and Peterson.¹⁷

The synthetic basal medium used to assay nicotinic acid would seem to be particularly useful as a general basal medium; if any of the ingredients are essential for growth (as opposed to being just helpful in increasing growth a little), which is believed to be the case with biotin, pantothenic acid and maybe some of the amino acids, it ought to be possible, by suitable re-arrangement of the basal medium, to assay these components. We understand that this has been done with biotin and we, ourselves, have had some success with pantothenic acid. The standard curve (0.0–0.1 $\mu\text{g}/\text{tube}$) is actually a curve and not a straight line, but the following results were obtained on a laboratory milled white flour. The pantothenic acid was extracted from 1 g of the flour, which was suspended in 100 ml of distilled water, the pH adjusted to 6.8, and the soln. autoclaved for 20 min. at 15 lb. pressure. Then 2 ml of 2.5 M sodium acetate soln. were added, the pH was adjusted to 4.8, and the volume was made up to 200 ml. This soln. was centrifuged and filtered, and a 50-ml aliquot of the filtrate was adjusted to 6.8 and made up to 100 ml. 1, 2 and 3 ml of this solution gave results of 6.8, 7.0 and 6.9 $\mu\text{g}/\text{g}$ when determined on the standard curve, made with pure calcium *d*-pantothenate, ranging from 0.0 to 0.10 μg .

It is true that a more convenient method for assaying pantothenic acid may be that described by Strong, Feeney and Earle,¹⁸ in which *Lactobacillus helveticus* and a fairly simple medium are used, but our experience is mentioned as an illustration of a general principle.

We wish to record our thanks to Dr. A. J. Amos for his interest and help in this work and especially for his assistance in preparing this paper.

REFERENCES

- Nicholls, J. R., Booth, R. G., Kent-Jones, D. W., Amos, A. J., and Ward, H. H., *ANALYST*, 1942, **67**, 15.
- Report by the Vitamin B, Sub-Committee of the Accessory Food Factors Committee of the Medical Research Council and the Lister Institute, *Biochem. J.*, 1943, **37**, 433.
- Najjar, V. A., *J. Biol. Chem.*, 1941, **141**, 355.
- Kodicek, E., *Biochem. J.*, 1940, **34**, 712, 724.
- Snell, E. E., and Strong, F. M., *Ind. Eng. Chem., Anal. Ed.*, 1939, **11**, 346.
- Barton-Wright, E. C., and Booth, R. G., *Biochem. J.*, 1943, **37**, 25.
- Strong, F. M., and Carpenter, L. E., *Ind. Eng. Chem., Anal. Ed.*, 1942, **14**, 909.
- Price, S. A., and Graves, H. C. H., *Nature*, 1944, **153**, 461.
- Macrae, T. F., Barton-Wright, E. C., and Copping, A. M., *Biochem. J.*, 1944, **38**, 132.
- Snell, E. E., and Wright, L. D., *J. Biol. Chem.*, 1941, **139**, 675.
- Krehl, W. A., Strong, F. M., and Elvehjem, C. A., *Ind. Eng. Chem., Anal. Ed.*, 1943, **15**, 471.
- Barton-Wright, E. C., *Biochem. J.* (in press).
- Shankman, S., Dunn, M. S., and Rubin, L. B., *J. Biol. Chem.*, 1943, **151**, 511.
- Shankman, S., *Id.*, 1943, **150**, 305.
- Shankman, S., Dunn, M. S. and Rubin, L. B., *Id.*, 1943, **150**, 477.
- Hegsted, D. M., *Id.*, 1944, **152**, 193.
- Hutchings, B. L., and Peterson, W. H., *Proc. Soc. Exper. Biol. Med.*, 1943, **52**, 36.
- Strong, F. M., Feeney, R. E., and Earle, A., *Ind. Eng. Chem., Anal. Ed.*, 1941, **13**, 566.

88, MADELEY ROAD, EALING
LONDON, W.5

September 1944

The discussion that followed the reading of the paper will be reported in the December issue.—EDITOR.

A Detailed Analysis of the Back Fat of the Pig, with Special Reference to the C₂₀₋₂₂ Unsaturated Acids

BY P. B. D. DE LA MARE, M.Sc., AND F. B. SHORLAND, M.Sc., Ph.D., F.N.Z.I.C.

BROWN and Deck,¹ from the yield of ether-insol. bromides derived from the methyl esters of the acids obtained by hydrolysis of commercial lard, reported up to 0.4% of highly unsaturated acids. These appeared from the m.p. of the bromides (228° C.) to be arachidonic acid. The fat from pigs fed on menhaden oil was shown² to contain the still more unsaturated acids of fish oil, with polybromide methyl esters darkening at 200° C. but not melting at 250° C. Banks and Hilditch³ isolated from the acids of fat of pigs fed on a mixed diet (including wheat middlings, barley meal and fish meal) ether-insol. bromides not melting at 230° C. These workers, and subsequently Dean and Hilditch,⁴ and Hilditch, Lea and Pedely,⁵ found by ester-fractionation of pig depot fat 1-3 mols. % of C₂₀₋₂₂ acids. Hilditch and Pedely⁶ used an empirical method for the approximate determination of these acids in pig depot fat. From their results it may be calculated that the yield of ether-insol. polybromides was not a constant percentage of, and that the amounts of C₂₀₋₂₂ acids (calculated as arachidonic acid from the polybromide number⁷⁻⁸) were considerably less than, the total amount of C₂₀₋₂₂ acids calculated from the ester-fractionation data. There is no doubt that, for pigs fed on diets similar to those of the pigs used by Hilditch and Pedely, their method is valid within the limits claimed for the ester-fractionation procedure. Nevertheless the above discrepancies suggested that the C₂₀₋₂₂ acids of pig fat were worthy of more detailed study.

EXPERIMENTAL—In the course of investigations⁹ in this laboratory of the effect of diet on the carcase quality of the pig, a larger sample (415 g) of pig back fat was analysed by the ester-fractionation procedure. The bulked inner and outer back fat was supplied by Mr. C. E. Ballinger, Research Officer of the Ruakura Animal Research Station, New Zealand Government Department of Agriculture, and came from a Berkshire sow fed on buttermilk only and killed at 200 lb. live weight.

The methyl esters (407 g) were crystallised three times from acetone (15 ml per g) at -35° C., and the "solid" and "liquid" fractions were separately distilled in a column of the type described by Longenecker¹⁰. Details of the main fractionation are given in Table I. The methyl esters of fractions L₁ and L₂ were combined and re-fractionated, with the results given in Table II. The acids from fractions L₁₄, L₁₅ and L_R after removal of unsaponifiable matter were re-methylated and re-fractionated. The results of this fractionation are given in Table III. Table IV records the composition of the fatty acids from the fat, calculated from the ester-fractionation data in the usual manner.¹¹

TABLE I—FRACTIONAL DISTILLATIONS OF METHYL ESTERS OF PIG BACK FAT*

Solid esters†				Liquid esters‡					
Fraction No.	Wt. g	b.p. (°C.) (ca. 0.1 mm)	Sap. equiv.	Iod. val. (Wijs 1 hr.)	Fraction No.	Wt. g	b.p. (°C.) (ca. 0.1 mm)	Sap. equiv.	Iod. val. (Wijs 1 hr.)
S ₁	7.73	120	267.8	1.0	L ₁	25.77	80-100	266.6	59.2
S ₂	59.87	120	272.3	1.4	L ₂	19.49	100-114		
S ₃	66.45	120-140	282.3	5.0	L ₃	3.34	114	276.3	69.4
S ₄	9.21	140	298.7	5.8	L ₄	12.51	114	282.8	77.4
S _R	2.24	residue	314.7	21.7	L ₅	5.61	114-116	284.9	78.4
			306.7‡		L ₆	11.45	116-120	290.6	84.5
					L ₇	17.57	120-124	293.4	87.1
Total	145.50				L ₈	20.49	124	294.0	88.3
					L ₉	22.93	124	295.3	89.5
					L ₁₀	20.38	124	294.9	88.9
					L ₁₁	34.52	124	294.2	89.6
					L ₁₂	21.46	124	295.2	91.0
					L ₁₃	20.56	124	293.7	89.2
					L ₁₄	5.55	124-135	300.0	99.5
					L ₁₅	2.59	135-150	314.2	110.3
					L _R	3.50	residue	375.4	123.1
								315.5**	
					Total	246.72			

* Inner and outer back fat I.V. 54.3

† Solid esters I.V. 3.6

‡ Liquid esters I.V. 84.6

§ Esters freed from unsap. matter

** Mean of re-fractionation data (Table III)

TABLE II—RE-FRACTIONATION OF FRACTIONS L₁ AND L₂.

Fraction No.	Wt. g	b.p. (°C.) (ca. 0.1 mm)	Sap. equiv.	Iod. val. (Wijs 1 hr.)
L ₁₂₁	1.00	55-74	209.8	15.3
L ₁₂₂	2.00	74	235.2	10.4
L ₁₂₃	1.87	74-86	240.2	7.6
L ₁₂₄	2.58	86	241.4	6.1
L ₁₂₅	2.05	86-95	244.2	10.3
L ₁₂₆	1.92	95-100	255.2	42.3
L ₁₂₇	2.34	100	265.8	70.9
L ₁₂₈	2.53	100	268.1	78.4
L ₁₂₉	2.54	100	268.8	73.9
L ₁₂₁₀	3.69	100	266.8	61.5
L ₁₂₁₁	4.40	100	272.4	54.1
L _{12R}	16.53	residue	297.1	84.0
			294.4*	
Total	43.45			

*Esters freed from unsaponifiable matter.

TABLE III—FRACTIONAL DISTILLATION OF THE COMBINED METHYL ESTERS FROM FRACTIONS L₁₄, L₁₅, AND L_R.*

Fraction No.	Wt. g	b.p. (°C.) (ca. 0.1 mm)	Sap. equiv.	Iod. val. (Wijs 1 hr.)
R ₁	3.47	113	303.0	97.5
R ₂	1.31	113	306.4	102.9
R ₃	1.32	113-120	320.5	110.9
R ₄	0.62	120-140	317.4	133.0
R _R	0.99	residue	334.7	137.4
			328.2*	
Total	7.71			

* Esters freed from unsaponifiable matter.

TABLE IV—COMPOSITION OF PIG BACK FAT

Fatty acids		"Solids" Wt. % (37.30%)	"Liquids" Wt. % (62.70%)	Totals Wt. %	Totals Wt. %*	Totals mols. %*	Mean unsatura- tion†*
Saturated							
as	C ₁₀	—	0.03	0.03	trace	0.05	
	C ₁₂	—	0.27	0.27	0.3	0.4	
	C ₁₄	0.14	2.14	2.28	2.3	2.7	
	C ₁₆	24.88	2.75	27.63	27.7	29.3	
	C ₁₈	10.63	—	10.63	10.6	10.2	
Unsaturated							
as	C ₁₂	—	0.03	0.03	trace	trace	as 2.0
	C ₁₄	—	0.15	0.15	0.2	0.2	.. 2.0
	C ₁₆	0.02	5.15	5.17	5.2	5.5	.. 2.0
	C ₁₈	1.41	50.82	52.23	52.3	50.4	.. 2.1
	C ₂₀	0.20	1.22	1.42	1.4	1.3	.. 3.0(approx.)
	N.S.	0.02	0.14	0.16	—	—	—

* Mean deficiency of H atoms per g mol. † Excluding unsap. matter.

DISCUSSION—The analysis is, on the whole, similar to those recorded by Hilditch, Lea and Pedely⁵ for the back fat of pigs fed on diets low in fat. There is indicated the presence of small amounts (≥ 0.1 mol. %) of an unsaturated acid of molecular weight lower than that of tetradecenoic acid. There seems no doubt of the presence of a small amount (ca. 0.4 mol. %) of lauric acid, as found by other workers,⁵ together with traces ($\geq 0.1\%$) of an acid of still lower mol. weight. These minor component acids may originate from the low mol. weight acids of dietary milk fat.

Table III is difficult to interpret, but indicates clearly that only a fraction of the C₂₀₋₂₂ acids is highly unsaturated. Crystallisation of the acids from fraction R₃ from acetone at -35° C. yielded two fractions, as shown in Table V

TABLE V—CRYSTALLISATION OF THE ACIDS OF FRACTION R₃ FROM ACETONE

Fraction No.	Wt. g	Sap. equiv. (esters)	Iod. val. (acids)	m.p. (°C.) acids
R ₃ insoluble	0.304	325.9	84.4	18
R ₃ soluble	0.605	315.4	137.8	—

Oxidation with alkaline permanganate of 0.28 g of the insol. fraction gave 0.08 g of light-petroleum insol. material, m.p. 122° C., which on recrystallisation from ethyl acetate gave 0.05 g of m.p. 128° C. Analysis of this material by Mr. R. N. Seelye of this laboratory gave the following results: C, 63.9; H, 10.2% (theory for tetrahydroxy-arachidic acid C, 63.8; H, 10.6%).

It seems probable, therefore, that this fraction contained a considerable proportion of a diethenoid C₂₀ acid. Acids of this type have not previously been reported in animal depot fats. The low iodine value of the fraction (84.4) suggests that it was by no means pure, and this is also true of the soluble fraction from R₃, which from its sap. equiv. (315.4) was probably contaminated with C₁₈ unsaturated acids. Oxidation of the latter fraction with alkaline permanganate gave (from 0.21 g) 0.04 g of petrol-insol. material which after two crystallisations from ethyl acetate had m.p. 118–120° C. Bromination in ether at 0° C. of a second portion (0.34 g) of the soluble fraction gave only oily bromides.

Bromination of fraction R₄ in ether at 0° C. yielded (from 0.336 g) 0.033 g of ether-insol. bromides darkening at 150° C. but not melting at 270° C. Similar bromination of fraction R₂ yielded much dark oil and 0.021 g of black precipitate from 0.623 g of acid.

The above results are interpreted as indicating the presence in this fat of a trace of highly unsaturated C₂₀₋₂₂ acids. These are absent from fractions R₁, R₂ and R₃. From the weight of isolated ether-insol. polybromides, it being assumed that the polybromide number of arachidonic acid is 85,⁷ the original total acids contained 0.04 mol. % of C₂₀₋₂₂ highly unsaturated acids calculated as arachidonic acid. This probably represents the minimum amount present, while the maximum figure, obtained by assuming that fraction R₂ consisted entirely of these acids (polymerised and therefore not yielding polybromides quantitatively) is 0.4 ml. %. Details of the nature of these acids are obscure, but their low volatility, the relatively high sap. equiv. of R₂ freed from unsap. matter, and the properties of the derived ether-insol. polybromides suggest that they may be largely of the C₂₂ series.

The subject is under further examination and these tentative conclusions are presented because of the report¹² of the possible presence of an eicosenoic acid in human depot fat. It is interesting that in this fat also the isolated C₂₀ fraction appeared to be a complex mixture of acids. The discrepancies found by us and by other workers between the amount of arachidonic acid calculated from the weight of isolated polybromides and the amount of C₂₀ acids calculated from the ester-fractionation data supports the contention that in pig back fat the C₂₀ acids are not entirely "highly unsaturated." A similar discrepancy exists with sheep body fats, the amount of C₂₀₋₂₂ acids reported by the above methods being 0.1%¹³ and 0.5–1.0 mol. %¹⁴ respectively. It seems possible, therefore, that diethenoid C₂₀ acids are more widely distributed in animal fats than has previously been suspected.

REFERENCES

1. Brown, J. B., and Deck, E. M., *J. Amer. Chem. Soc.*, 1930, **52**, 1135.
2. Brown, J. B., *J. Biol. Chem.*, 1930, **90**, 133.
3. Banks, A., and Hilditch, T. P., *Biochem. J.*, 1932, **26**, 298.
4. Dean, H. K., and Hilditch, T. P., *Id.*, 1933, **27**, 1950.
5. Hilditch, T. P., Lea, C. H., and Pedelty, W. H., *Id.*, 1938, **33**, 493.
6. Hilditch, T. P., and Pedelty, W. H., *ANALYST*, 1939, **64**, 640.
7. Ault, W. C., and Brown, J. B., *J. Biol. Chem.*, 1934, **107**, 675.
8. Bosworth, A. W., and Sisson, E. W., *Id.*, 1934, **107**, 489.
9. Shorland, F. B., Hansen, and Hogan, *Emp. J. Expt. Agric.* (in press).
10. Longenecker, H. E., *J. Soc. Chem. Ind.*, 1937, **56**, 199r.
11. Hilditch, T. P., "The Chemical Constitution of Natural Fats," Chapman & Hall, London, 1941, p. 386.
12. Cramer, D. L., and Brown, J. B., *J. Biol. Chem.*, 1943, **151**, 427.
13. Brown, J. B., and Sheldon, C. C., *J. Amer. Chem. Soc.*, 1934, **56**, 2149.
14. Hilditch, T. P., and Pedelty, W. H., *Biochem. J.*, 1941, **35**, 932.

The Determination of Tin in Steels

BY A. ROBERTSHAW AND G. C. BROMFIELD, ASSOC. MET. (SHEFF.)

RECENT evidence has shown that during the last few years there has been a tendency for steels to become contaminated with tin in amounts up to 0.5%. This is probably due to the use, during war time, of questionable supplies of scrap materials. Since tin has a marked effect on the mechanical properties of certain classes of steels¹ and recent experience in this Department has shown that the presence of tin may cause embrittlement in certain types of spring steel, its accurate determination is of some importance.

The gravimetric determination, in which the tin is finally weighed as oxide after precipitation as sulphide and isolation from other elements, similarly precipitated, involves a fair amount of time and, in certain alloys, considerable skill.² In absence of chromium, an alternative procedure involving pptn. as phosphate has recently been proposed.³ To avoid long and tedious separations we decided to investigate the accuracy of a volumetric method, particularly with regard to the interfering elements likely to be encountered. These are stated to be arsenic, chromium, molybdenum, vanadium, copper and tungsten.⁴

Most of the methods proposed for the iodimetric titration of tin in steel depend on a preliminary separation with hydrogen sulphide in acid solution,⁵ isolation of the sulphide, reduction with powdered antimony, iron wire, aluminium wire, lead or nickel shot, and the titration of the stannous chloride with iodine in an inert atmosphere. Some workers rely merely on the effect of solution of the steel in hydrochloric acid to reduce the tin to stannous chloride. It is considered that attack by means of hydrochloric acid may, particularly with highly alloyed steel, be insufficient to ensure complete solution of the tin. In the method described, therefore, complete solution is effected by dil. sulphuric acid and solid potassium permanganate. The solution is reduced by nickel in 1 : 4 hydrochloric acid containing sodium chloride, as follows.

METHOD—To 2 g of the sample contained in a round, flat-bottomed 500-ml flask, add 70 ml of sulphuric acid (15%) and dissolve as far as possible with the aid of gentle heat. Cool somewhat, add 2 g of solid potassium permanganate, and simmer gently for 10 min. Reduce the soln. with *ca.* 25 ml of a saturated soln. of sulphurous acid and simmer for 5 min. to remove excess. Remove from the source of heat and add 10 g of sodium chloride, 50 ml of conc. hydrochloric acid and 200 ml of water.

Place the nickel coil assembly in the neck of the flask, with the coil just clear of the bottom and projecting slightly above the surface of the liquid and with the long delivery tube stoppered. Heat rapidly to boiling, simmer gently until all the iron appears reduced, and continue for another 45 min. to complete the reduction of the tin, making approx. 1 hr. in all. Remove the flask from the source of heat and without delay pass a steady stream of oxygen-free carbon dioxide through the previously stoppered tube. Immerse the flask in cold water, taking care that no back-flow of air takes place. Continue the passage of carbon dioxide until the soln. is quite cold. Remove the nickel coil assembly and rinse quickly with freshly boiled water. Add 10 ml of potassium iodide soln. and a little starch soln. and, without undue delay, titrate to the first permanent blue with the standard iodate soln.

The strength of the iodate solution may be periodically checked by carrying a tin-free carbon steel through the entire procedure, the standard tin solution being added immediately prior to the reduction with nickel. Standard sodium thiosulphate soln. provides a more rapid means of checking; the agreement between the two methods is very close. Cooling of the solution while passing carbon dioxide presents little difficulty. An apparatus for making 6 determinations at a time can readily be set up.

Apparatus—The nickel coil assembly consists of a nickel sheet, 8 in. \times 2 in., wound into the form of an open coil which is supported at the end of a bent glass rod. A delivery tube for the carbon dioxide and a short exit tube are also fitted (see Fig. 1). Into the delivery tube, which is provided with some form of stopper, is passed a length of nickel wire. Before it is mounted the nickel coil is well etched by boiling in 1 : 1 hydrochloric acid saturated with sodium chloride. The nickel spiral must be cleaned with 1 : 1 nitric acid on each occasion before use, all traces of acid being removed in running water. By using nickel sheet of 0.025 in. in thickness, each coil will last for at least 10 determinations.

Solutions—Dil. sulphuric acid: 15% by vol. Potassium iodide: 15% w/v with freshly boiled water. Starch solution: 1 g of soluble starch in 100 ml of water, freshly prepared. Potassium iodate: 1.19 g of potassium iodate dissolved in water and made up to one litre. (1 ml \equiv 0.10% of tin on a 2-g sample.) Standard tin solution: To 2 g of spectrographically pure tin, add 15 ml of H_2SO_4 (sp.gr. 1.84) and heat until the salts are white. Cool, dissolve by gently warming with 1 : 4 hydrochloric acid, cool and make up to 1 litre with 1 : 4 HCl. (1 ml \equiv 0.002 g of tin \equiv 0.10% on 2 g.)

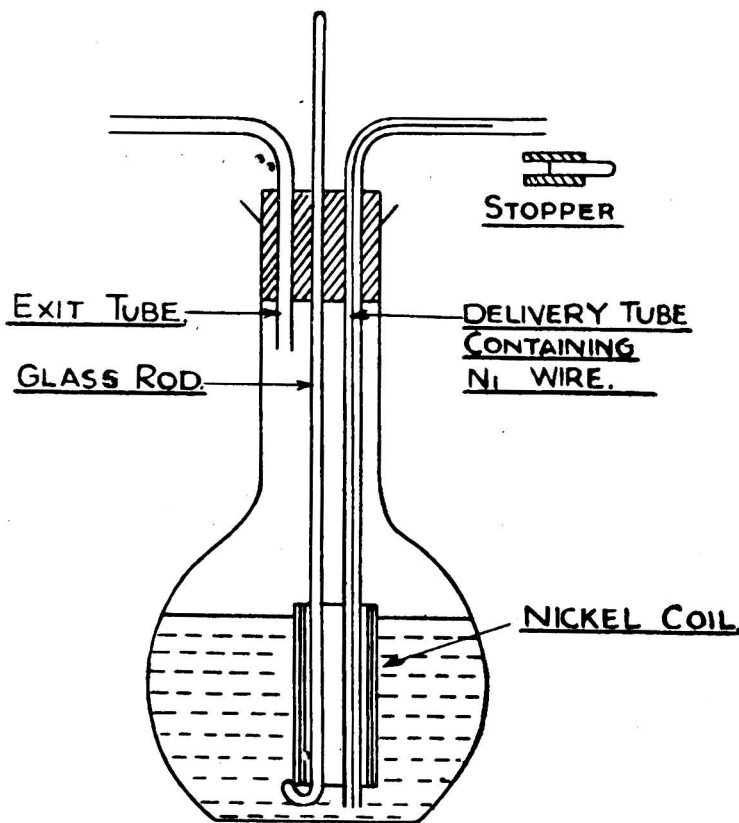

NICKEL COIL ASSEMBLY IN USE

Fig. 1

EXPERIMENTAL—To determine whether the tin had completely dissolved, 6 samples of varied composition containing from 0.20 to 0.70% of tin were carried through the procedure as described, to the final cooling stage. Then, however, instead of being titrated, the solns. were filtered through paper-pulp filters, and the paper was washed free from chlorides with hot water. Although no residue was apparent, the pulp filters were ignited, combined and fused with sodium hydroxide and a little sodium peroxide. The melt was extracted in hydrochloric acid, the strength was adjusted to 1 : 4, and the soln. was reduced with nickel as described, cooled and titrated. The tin thus recovered from the six 2-g samples was less than 0.0001 g. Absence of tin from any insoluble substances was confirmed by spectrographic examination of a further 6 residues similarly prepared.

To examine the effect of possible interfering elements, 2-g samples of tin-free carbon steels were dissolved in the manner described to the stage where excess of sulphurous acid had been removed. To these solns. were added metals in the form of their salts (other than nitrates)

together with the standard soln. of tin. The solutions were then reduced as detailed, and the results obtained are given in the following table.

TABLE I

	Tin		Tin	
	added %	recovered %	added %	recovered %
Carbon steel ..	0.25	0.25	0.50	0.50
" + 1% Cu ..	"	0.25	"	0.51
" + 0.5% Sb ..	"	0.245	"	0.495
" + 0.5% As ..	"	0.245	"	0.50
" + { 1.0% Cu 0.5% Sb 0.5% As	0.25	0.245	0.50	0.515
" + 1.0% Mo ..	0.25	0.25	0.50	0.505
" + 2.5% Cr ..	"	"	"	0.51
" + 1.5% V ..	"	0.265	"	0.55
" + { 1.0% Mo 2.5% Cr 1.5% V	0.25	0.26	0.50	0.55
" + 5.0% Co ..	0.25	0.25	0.50	0.50
" + 0.5% W ..	"	—	"	—
" + { 1.0% Cu 0.5% Sb 0.5% As 1.0% Mo 2.5% Cr 1.5% V 5.0% Co	0.25	0.265	0.50	0.55

Repetition of these expts. gave substantially the same figures. As was expected, tungsten in very small amounts rendered the method unworkable, owing to the formation of the intensely blue lower oxide during reduction. From the results shown, the only other interfering element would appear to be vanadium, other results being considered within experimental error. The interference due to tungsten was prevented by a separation procedure, and that of vanadium was further examined.

Interference of vanadium—To samples of tin-free steel were added different increments of vanadium up to a maximum of 3.0%. The titration in each test was under 0.10 ml, showing that vanadium alone is not reduced to a state directly oxidisable with iodine. In presence of tin, however, a returning end-point was observed during the titration, leading to an assumption that either—(a) the tin catalyses the oxidation of the vanadium salt by the iodine, or (b) oxidation of the vanadium by stannic chloride takes place.

When, however, the vanadium content of the steel is less than 1.0% and the titration is rapid to the first blue "flash," the error in tin determinations of the amount stated is negligible. This is indicated in the following table.

TABLE II

	Tin	
	added %	recovered %
Carbon steel ..	0.50	0.50
" " + 0.25% of vanadium ..	"	0.495
" " + 0.50% " " ..	"	0.505
" " + 0.75% " " ..	"	0.50
" " + 1.00% " " ..	"	0.505
" " + 2.00% " " ..	"	0.565

METHOD FOR STEELS CONTAINING TUNGSTEN—Effect solution as described above. After boiling off the excess of sulphurous acid, add 50 ml of conc. hydrochloric acid. Mix the solution and add 20 ml of cinchonine solution (10% in 1 : 3 sulphuric acid). Heat to boiling and digest for 30 min. Filter through pulp into a flat-bottomed 500-ml flask, wash three times with (1 : 30) cinchonine soln., and discard the ppt. Add to the filtrate 10 g of sodium chloride, adjust to approx. 300 ml, and reduce the solution as already described.

It will be found that cinchonine momentarily gives a ppt. during titration. This,

however, is not permanent and the accuracy is unaffected. A possible source of error of this method was investigated. The ppt. of tungstic oxide was found to carry down very small traces of tin; to recover this the tungstic oxide may be dissolved in ammonium hydroxide, any residue fused with sodium hydroxide and a little sodium peroxide added to the main filtrate. This was found unnecessary in routine work, as was shown by the following results, in which no account was taken of the tin carried down by the tungstic oxide.

B.C.S. Sample W2 (16% W)	Tin found 0.04%
" " + 0.50% Sn added	" " 0.53%

Of 0.50% added, 0.49% was recovered, and this was confirmed by several experiments.

CONCLUSIONS—This work indicated that tin in steel in amounts less than 0.5% could be rapidly determined by the procedure outlined, with an accuracy greater than most gravimetric methods. The only interfering elements likely to be encountered are tungsten and vanadium. A simple modification could be applied to deal with tungsten, whilst the error due to vanadium present in amounts less than 1.0% had no serious effect on the accuracy of the determination.

Since completing this work, the supply position of cinchonine has become so acute that an alternative procedure for the complete removal of tungsten involving the use of Rhodamine B⁶ is being investigated. In the meantime, whenever the use of cinchonine is considered necessary, recovery is essential. A method for this recovery may be obtained from the Ministry of Supply.

We are indebted to the Director of Scientific Research, Admiralty, for permission to publish this work.

REFERENCES

1. Halley, J. W., *Amer. Inst. Min. and Elect. Engineers*, Sept., 1942.
2. Gregory, E., and Stevenson, W. W., "Chemical Analysis of Metals and Alloys," 1937.
3. Wheeler, W. C. G., *ANALYST*, 1943, 68.
4. Scott, W. W., "Standard Methods of Chemical Analysis," 1939. Lundell, G. E. F., Hoffman, J. I., and Bright, H. A., "Chemical Analysis of Iron and Steel," 1931. Pigott, E. C., "Chemical Analysis of Ferrous Alloys," 1941.
5. Lundell, G. E. F., Hoffman, J. I., and Bright, H. A. (*loc. cit.*)
6. Oates, J. T., *Eng. Min. J.*, April, 1943.

BRAGG LABORATORY
SHEFFIELD

July, 1944

Notes

THE FRUIT CONTENTS OF JAMS

SINCE the publication of the paper by C. L. Hinton in 1934 on the Examination of Fruits and Jams by Lead Precipitation,¹ the determination of lead numbers of jams has frequently been carried out in this laboratory, and in some instances has proved of great value in the estimation of a particular fruit in jam.

The relatively high aqueous lead numbers per 1% of total acid of the soft fruits, such as raspberry, strawberry, blackcurrant, etc., are due to their high citric acid content as compared with other fruits, such as plum and apple, and it would appear that a much more direct method of approach is feasible. A simple determination of citric acid itself would give practically all the information that lead numbers give and would possess the following advantages:

- (1) The amount of jam required could be reduced to as little as 25 g or less.
- (2) The determination of total fruit acid would frequently not be required.
- (3) The long, complicated and highly empirical method for determining lead numbers would be replaced by a straightforward citric acid determination.
- (4) The determination of sulphate in the jam, which affects the lead numbers, would not be required.
- (5) If the grouping of the fruits, as suggested below, be substantiated by further data, the proportion of a fruit belonging to group 1 or group 2, in the presence of a fruit of group 3, could be calculated directly from the citric acid content.

The simplification introduced by direct citric acid determination, in place of lead numbers, may be exemplified as follows. Hinton's formula for calculating the fruit content of a mixed jam is

$$F_1 = \frac{100a(l - L_2)}{A_1(L_1 - L_2)}$$

where F_1 is the per cent. of the fruit being determined, a is the per cent. of total acid in the jam, l is the aqueous lead number per 1% of acid in the jam, A_1 is the per cent. of total acid in the fruit, and L_1 and L_2 are the aqueous lead numbers per 1% of acid of the respective fruits. In this formula, A_1 , L_1 and L_2 are all variants for which extreme figures may have to be taken into account, leading to wide discrepancies in the "estimate" of the fruit content.

The formula for calculating the fruit content of a mixed jam from a direct citric acid determination may be expressed in a similar manner, *viz.*,

$$F_1 = \frac{100a(c - C_2)}{A_1(C_1 - C_2)}$$

where c is the per cent. of citric acid in the total acid, a , of the jam, and C_1 and C_2 are the percentages of citric acid in the total acid of the respective fruits.

For the mixture of fruits envisaged in (5) above, it appears likely that C_2 , the per cent. of citric acid in the group 3 fruit, may be neglected, and the formula may then be simplified to

$$F_1 = \frac{100ac}{A_1C_1};$$

but ac is the per cent. of citric acid in the jam, and A_1C_1 is the per cent. of citric acid in the group 1 or group 2 fruit, the estimate of which is dependent only on the variation in the citric acid content of the particular fruit.

The following figures for citric acid and free and combined acid, calculated as citric acid, on single specimens of the common jam fruits have been obtained during this season.

Citric acid was determined by the method of Hartmann and Hillig, as described in the "Methods of Analysis of the A.O.A.C."²; it should be noted that the formula employed therein gives *anhydrous* citric acid.

Free and combined acid was determined on the aqueous extract by Hinton's methods.

	Citric acid (hydrated) Direct deter- mination	Acid, expressed as citric acid (hydrated)			Citric acid in total acid %
		Free	Combined	Total	
		%	%	%	
Strawberry	1.08	1.01	0.45	1.46	69.5
Raspberry	1.84	2.11	0.31	2.42	76.0
Blackcurrant	3.16	3.71	0.80	4.51	70.1
Redcurrant	2.19	2.24	0.45	2.69	81.4
Loganberry	1.11	2.21	0.45	2.66	41.7
Gooseberry	1.28	2.12	0.40	2.52	50.8
Apple*	<0.02	1.72	—	—	—
Apple*	<0.02	1.20	0.25	1.45	<1.4
Plum (purple)† ..	0.02	2.40	0.41	2.81	0.7
Plum (golden)† ..	<0.03	1.95	0.57	2.52	<1.2
Blackberry	<0.03	1.96	0.52	2.48	<1.2
Rhubarb	0.22	1.86	0.56	2.42	9.1

*Peeled and cored fruit. † Stoned fruit.

The fruits examined may be divided into 3 groups according to the percentage of citric acid in the total acid: (1) the soft fruits: strawberry, raspberry, blackcurrant and redcurrant; (2) fruits with intermediate citric acid content: loganberry, gooseberry and rhubarb; (3) fruits with little or no citric acid: plum, apple and blackberry.

There was no indication of any citric acid in the fruits of group 3, with the exception of the purple plums, in which a trace was obtained.

I have not the facilities for compiling sufficient data to obtain average and extreme citric acid contents of the jam fruits, but such data would, I believe, be of great value to Public Analysts and others who are faced with these problems.

REFERENCES

1. Hinton, C. L., *ANALYST*, 1934, **59**, 248.
2. "Methods of Analysis of the A.O.A.C.," 5th Ed., p. 343.

PUBLIC ANALYSTS' LABORATORY
16, SOUTHWARK STREET, LONDON, S.E.1

D. D. MOIR
September, 1944

ESTIMATION OF SMALL QUANTITIES OF DIPHENYLAMINE

THE colour change of diphenylamine in presence of oxidising agents is used as a test for both substances, and the former has found some use in volumetric work as an internal indicator in titrations with oxidising agents. The amine is first oxidised to diphenylbenzidine and this is followed by further oxidation to diphenylamine violet, which has an intense blue colour in solutions of high acidity (above 4 N). The production of this blue colour has been made the basis of a method of estimating small quantities of diphenylamine.

PROCEDURE—The amounts of reagents used were adjusted so that the final light absorption could be conveniently carried out in a 4-cm cell.

Add to a soln. of the amine in 21 ml of water 0.2 ml of a soln. of potassium dichromate (0.1 g per 250 ml). Then add strong sulphuric acid slowly from a burette, with constant shaking and thorough cooling after each addition, until the final vol. is 30 ml. If other quantities are used, keep the ratio of the acid to the aq. soln. of the amine as above. Transfer the cold soln. to a 4-cm cell and measure the light absorption by means of a Spekker Absorptiometer, using a yellow filter and setting the instrument against a soln. containing only distilled water and the reagents.

RESULTS—For the work for which this method was developed, it was necessary to determine diphenylamine in salt water, and a calibration curve for such a series of solns., over the range 5–40 μg per final 30 ml of soln., was constructed. The sensitivity limit of the method is of the order of 2–3 μg per 30 ml of soln.

Acknowledgment is made to the Corrosion Committee of the Iron and Steel Institute for permission to publish this note, and to Dr. J. E. Harris for helpful discussions during the work.

THE MARINE STATION, KEPPEL PIER
MILLPORT, SCOTLAND

H. BARNES
July, 1944

A MICRO-PYKNOMETER

THERE is nowhere described in the standard text books on micro analysis a micro-pyknometer for 0.01 ml, or less, of liquid. That described below and shown in Fig. 1 has been found to give satisfactory results. It is in the form of a V with a 60° angle between the arms, each 12 cm. long. The bulb arm consists of two lengths of capillary glass hair, *ca.* 0.4 mm external diam. and 5 cm long, between which is the bulb, 1.75 mm external diam. and 2 cm long. The capillary arm is about 0.4 mm external diam. and 12 cm long. In my apparatus the internal diameter of the capillary hair is about 0.1 mm and that of the bulb about 0.6 mm.

The pyknometer may be constructed as follows. Melt glass tubing in the blow-pipe flame and pull it out to capillary tubing of about 2 mm external and 0.5 mm internal diam. Continue to heat in a large cool flame and pull off to the capillary hairs. To obtain the final V-shape, hold the bulb so that the hairs make an angle of 60° with the vertical, and bring a very small flame slowly up under the capillary hair about 5 cm from the bulb until the hair suddenly softens and falls; then remove the flame instantly. Arrange a stop vertically under the point of heating to prevent the hair from swinging too far. Cut off the hairs to the desired length.

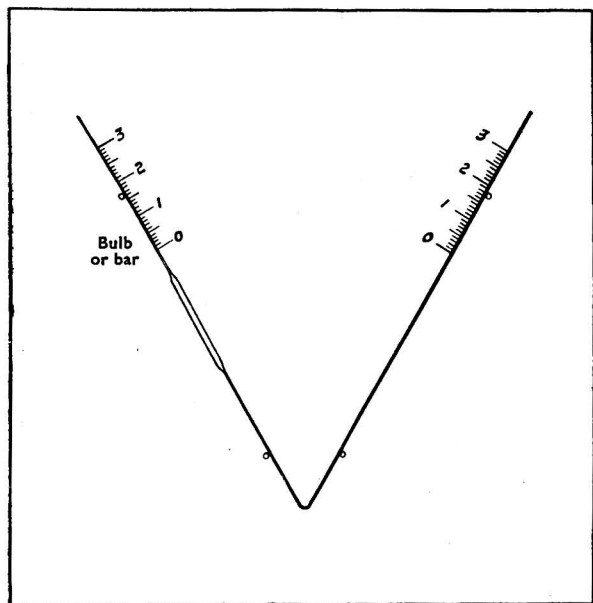

Fig. 1. A.—Pyknometer with scale marked on board

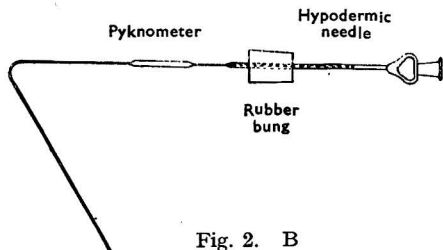

Fig. 2. B

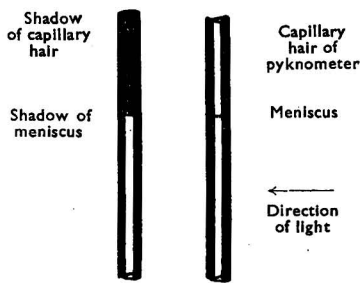

Fig. 4. D

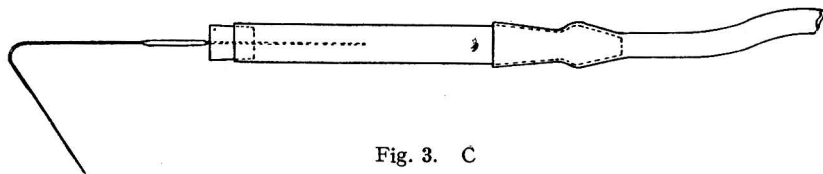

Fig. 3. C

The reason for the shape of the apparatus is as follows. It sits conveniently in the hooks and rests on the pan of a Kuhlmann micro-balance. It may be filled by dipping the capillary arm into liquid and allowing the bulb arm to hang down. Provided that the bulb is lower than the surface of the liquid the pyknometer will fill partly by capillarity and then by siphoning. A satisfactory pyknometer will fill with water in about 3 min. The capillary hair will dip into the capillary vessels where small quantities of liquids are usually kept.

To fill the pyknometer with viscous liquids, make the following assembly (Figs. 2 and 3). Fit a piece of glass tubing with a rubber stopper pierced by a small hole. Through this hole from the small to large end of the stopper push a hypodermic needle so that the point just projects. Into the needle place the bulb arm of the pyknometer up to the bulb. Withdraw the needle carefully with a straight pull and leave the pyknometer in the stopper. Replace the stopper in the tube and connect to a water-pump. For cleaning, suck chromic sulphuric acid mixture into the pyknometer and leave overnight. Replace the acid by water, alcohol and ether in turn, and finally dry the apparatus by sucking air through it. Remove the pyknometer from the stopper before weighing. For best results handle at the balance with chamois leather gloves or finger-stalls.

CALIBRATION AND USE—Determine the volume of liquid in the pycnometer with the aid of the pycnometer board (Fig. 1). This is a board, about 15 cm square, into which four stout pins are driven to form a 60° V, so that when dropped into this V the pycnometer always comes to rest in the same place. Graduations can now be made on graph paper glued to the board under the pycnometer arms. The meniscus of any liquid in the pycnometer can be read against these graduations. Suck mercury into the apparatus as for cleaning liquid. Put the pycnometer on the board and tilt the whole so that the mercury stands at the zero graduation on one arm while a reading is taken on the other arm. If the mercury does not move freely, tap the board. Re-tilt the board to repeat the process at the zero of the other arm. Then weigh the pycnometer. Remove some mercury and repeat the process several times to obtain sufficient points to plot calibration curves for both arms. This is necessary, since, owing to the method of construction, the capillary hairs may be slightly trumpet-shaped and not cylinders. Once calibrated, the apparatus can be used repeatedly.

An alternative method of calibration, which I prefer, depends on the fact that, owing to surface tension effects, liquids such as water will not flow out of the pycnometer even when tilted to give a head of liquid. Clean and weigh the pycnometer filled with water or other volatile liquid, and place it on the pycnometer board. Clamp the board in a nearly vertical plane, so that the end of one capillary arm is below the liquid level in the other. Liquid flows through the pycnometer until the lower arm is full when slow evaporation begins. Take readings on the upper capillary and weigh at suitable intervals.

From these figures plot a curve showing volume of upper capillary against graduation reading. Take any suitable arbitrary volume of liquid n in the pycnometer and tilt about, taking simultaneous readings on both capillaries. From the figures obtained and the graph already constructed draw a graph showing vol. of the lower capillary against the graduations.

For filling with a liquid whose density is to be determined, the siphon method is to be preferred, where applicable, since the suction method may evaporate a volatile component from a mixture or leave bubbles in the liquid if gases are dissolved. Since the siphon method of filling may take some time and the pycnometer will be left unattended, the first sign that it is full will be the presence of a very small drop on the end of the B arm. Remove the pycnometer from the filling liquid and apply a filter-paper to the end of one arm for a second or two, so that on the board the liquid will be at least 1 cm from both ends. Carefully wipe the pycnometer with wet and dry chamois leather in the normal way and transfer to the balance with gloved fingers. Weigh and read the volume. If very volatile liquids are being determined, readings may be taken before and after weighing, but I have found that with methyl iodide no measurable loss in weight occurred in 15 min. if the surface of the liquid was 1 cm from the ends. If, on the other hand, the liquid surface was at the end of one hair, rapid evaporation occurred and, to replace loss, liquid flowed in from the other arm. With colourless liquids it is sometimes very difficult to see the liquid in the hairs. If a strong light is reflected from the side of the hair as it lies on the board (Fig. 4) so as to cast a shadow on the board, the meniscus is very clearly seen in the shadow as a break from a solid black shadow at the top of the hair to a shadow with a light centre where the liquid is.

RESULTS—Assuming the pycnometer has a capacity of about 10 cmm, that it can be weighed to within 10 μ g and that the position of the meniscus can be read within 1 mm, then both the weighing and volume errors will be less than 0.1%. In practice both these errors can be reduced to a fifth of the above value, although, if the internal diameter of the capillary hairs much exceeds 0.1 mm, the volume error will rapidly increase, and the usual very strict precautions are necessary in weighing the pycnometer to 2 μ g. Another source of error is the drainage error due to the fact that the ratio of surface to volume of the capillary hairs is relatively large. If the density of a liquid is required at a temperature other than that of the balance room, it is only necessary to read the volume at the new temperature. By this means coefficients of expansion can be measured.

The following typical results were obtained in density determination with a micro-pycnometer, of about 0.012 ml capacity, calibrated at 20° C. with water, mercury, methyl iodide and ethyl iodide.

	Water	Mercury	Methyl iodide	Ethyl iodide
Density assumed for calibration	0.99823	13.546	2.2543	1.9333
Density found	0.9983	13.546	2.2549	1.9338
	0.9974	13.548	2.2536	1.9330
	0.9987	13.546	2.2533	1.9329
	0.9985	—	2.2545	1.9328

I wish to acknowledge the assistance received from Mr. H. A. B. Wilson, and to thank the Directors of Imperial Chemical Industries, in whose Explosives Group research laboratories this work was carried out, for permission to publish.

ROWANHURST, GROVE ROAD
BEACONSFIELD, BUCKS.

A. A. HOUGHTON
September, 1944

Labelling of Food Order

THE Wholesale Drug Trade Association has obtained the following rulings from the Ministry of Food as to the application of the Labelling of Food Order (S.R. & O., 1944, No. 738) to certain articles.*

Cod-liver Oil—Whether labelled as such, with or without a statement of the dose or a reference to its vitamin content, cod-liver oil is *not* subject to the provisions of the Order *unless* specific claims are made on the label indicating that the product is a food.

* *Pharm. J.*, September 16, 1944, p. 118.

Cod-liver Oil and Malt Extract, complying with the requirements of the B.P., is *not* subject to the provisions of the Order, provided that no indication is given that the product is a food.

Halibut-liver Oil, whether packed in bottles or capsules, is *not* subject to the provisions of the Order.

Food Colourings are *within* the provisions of the Order.

Tablets of Dried Yeast are *not* within the provisions of the Order. If a manufacturer wishes to found a claim to the presence of vitamin B on the inclusion of yeast, or extract of yeast, quantitative disclosure of the minimum vitamin content is necessary.

Ministry of Food

STATUTORY RULES AND ORDERS

1944 No. 1086. The Feeding Stuffs (Regulation of Manufacture) Order,* 1944, dated September 18, 1944. Price 4d.

THIS Order consolidates the Feeding Stuffs (Regulation of Manufacture) Order, 1943, and its amending Orders, and incorporates the terms of the General Licence, S.R. & O., 1943, No. 441, granted under the Feeding Stuffs (Regulation of Manufacture) Order, 1942. It also revises the formulae of national compounds and national livestock mixtures.

Apart from revising formulae the main change is to allow a manufacturer to calculate his permitted production of compounds, concentrates, or livestock mixtures in two periods of six months instead of four periods of three months.

Department of Scientific and Industrial Research

RAPID SURVEYS OF ATMOSPHERIC POLLUTION

ATMOSPHERIC pollution, which may be regarded as the chief cause of the difference between the air in towns and the fresh air of the countryside, may, in general, be said to consist of (i) relatively coarse solid matter, such as ash or grit, which is usually deposited fairly quickly near to its place of origin; (ii) fine solid matter, such as smoke, which remains suspended in the air for a relatively long time; (iii) gases, such as sulphur dioxide, emitted from domestic or industrial chimneys, engines, etc.

It is relatively simple to record the quantities of each of these forms of pollution and, from the records over a period of time, to determine whether the pollution in a town is changing in its quality or quantity. It is becoming increasingly important, however, to be able to make more rapid estimates of the distribution of pollution in a particular locality at any given time, since, although the normal type of recording apparatus is very simple, it cannot usually provide reliable information *quickly*.† Where such information is wanted at short notice, *e.g.*, as part of the consideration of post-war industrial or housing plans, it may be obtained with sufficient accuracy for the immediate purposes by the methods described below.

I. DEPOSITED SOLID MATTER.—The estimation of the rate of deposition of solid matter calls for only the simplest of apparatus; a number of shallow dishes, about 9 cm ($3\frac{1}{2}$ in.) in diam. These dishes (Petri dishes) are provided with lids which are only removed during actual exposure in an expt., or while the collected solid matter is being removed from the dishes before weighing.

The procedure is as follows. At least 9, and preferably more, sites for dishes are chosen at $\frac{1}{4}$ -mile intervals all over the area to be investigated, care being taken to select sites, preferably about 10 feet above ground, where interference by the public or by animals can be prevented. When there appears to be reasonable prospect of at least 48 hours of dry, calm weather the dishes should be distributed and their lids removed. After 48 hr., the dishes should be collected (the lids being replaced). If the dishes are collected in the order of distribution, the period of exposure will be approx. the same for each. The contents should be brushed on to a watchglass with a dry brush and weighed in the watchglass to an accuracy of 0.1 mg. The same watchglass should be used for all weighings.

It should be emphasised that the weather conditions during the expt. should be carefully watched, for if rain or strong wind occurs, the expt. will be a failure. What is required is a period of settled, anti-cyclonic weather. The direction of wind may be important, as it is often desirable to make observations in the prevailing wind or in a wind which blows pollution from a particular area.

At intervals during the expt. observations should be made of the wind and any changes in weather; also of any special sources of pollution. If rain threatens or a wind begins to spring up, the dishes should be covered and taken indoors; usually it will be wise to clean them and begin the expt. again when the weather clears. No special apparatus is necessary to determine wind direction, which should preferably be observed by noting the direction of the smoke issuing from a tall chimney; weather-cocks, flags, and even

* Obtainable from H.M. Stationery Office.

† It is important to recognise the limitations of rapid surveys. Thus even on meteorologically similar days there may be meteorological differences which will cause differences in the general level of pollution. Hence, while a rapid survey may be trusted to give a reasonably true picture of the distribution of pollution, it would not be safe to use the results of two rapid surveys separated by, say, a few years, to determine whether the general level of pollution was changing over that period. Such a determination could only be made by examining continuous records over the whole period.

clouds are not always reliable indicators. The wind velocity can be estimated roughly on the Beaufort scale as follows.

	Force (arbitrary units)	Velocity (m.p.h.)
Calm; smoke rises vertically	0	0
Direction shown by smoke-drift only, no pronounced sensation of air movement	1	2
Wind felt on face; leaves rustle	2	5
Leaves and small twigs in constant motion; light flag extends ..	3	10
Dust and loose paper raised (expt. invalidated by dust being blown in and out of the dishes)	4	15

At least three sets of exposures should be made, to ensure that the results obtained are correct measures of the normal rate of deposition and are not affected by abnormal conditions which may happen to have coincided with any one expt. It is unlikely that the actual weights collected in separate expts. at any one site will be the same, but they should be reasonably in proportion, and each separate experiment should, independently, agree with any conclusion drawn from the whole set of experiments.

Results can usually be conveniently presented on a map, with "contour lines" of equal pollution. When shown in this form it is easy to see at a glance where deposits of pollution are heaviest, although it should always be borne in mind that even in any one locality there may be, and often is, considerable variation in atmospheric pollution even from day to day, more from month to month, and most from summer to winter.

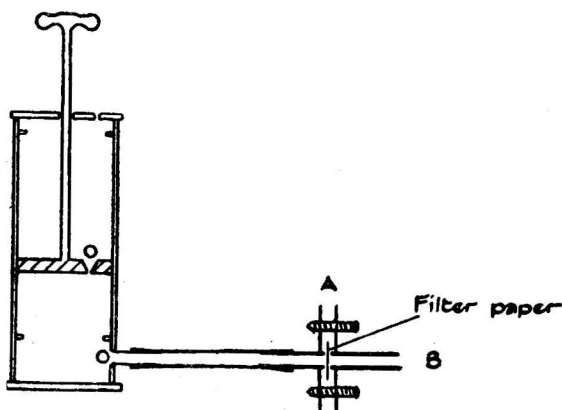

Fig. 1

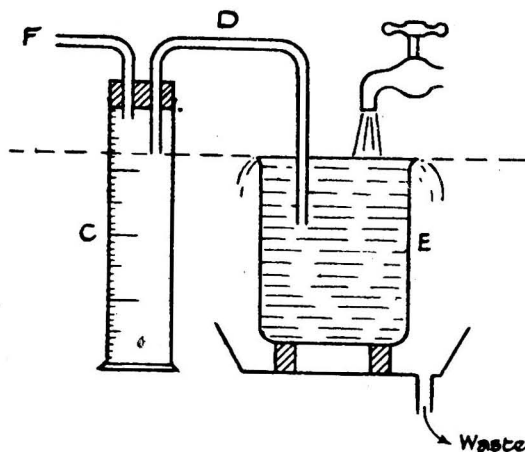

Fig. 2

II. SUSPENDED SOLID MATTER—The suspended solid matter (smoke) in the atmosphere cannot be measured so simply as deposited matter but, nevertheless, the procedure to be followed is still quite simple. A measured vol. of air is drawn through a white filter-paper and the suspended matter is trapped on the paper, producing a dark stain. The darkness of this stain is a measure of the amount of matter suspended in the air. Because the nature of the suspended matter may vary in different parts of the country, according to local circumstances, the proportion of light to dark particles may also vary and may produce stains of different intensities. Nevertheless, it is convenient to make use of calibrations made by the late Dr. J. S. Owens on the air of London to estimate the weight of matter making up the stain simply by visual estimation of the intensity of the stain. Although such estimated weights may not be entirely accurate in provincial districts, they may be taken as a reasonably close approximation and should show the relative amounts of suspended matter at a number of sites in any given locality.

The equipment required is: (i) a hand air-suction pump of capacity about 200 cu.cms. (The pump should, preferably, have a foot rest like the familiar stirrup pump); (ii) a pair of brass tubes of $\frac{1}{8}$ in. bore, each provided with flat ends between which a filter-paper may be clamped; (iii) a supply of suitable white filter paper; (iv) a standard scale of shades (Dr. Owens's scale) obtainable from Messrs. Casella, Fitzroy Square, London W.1. (i) and (ii) should be connected as shown in the attached drawings, with a filter-paper at A. The volume of air drawn through the filter-paper at each stroke of the pump must first be measured accurately. This may be done by connecting the inlet pipe B to the apparatus shown in Fig. 2. It is only necessary that the measuring jar or flask C shall have a capacity greater than the intake of the pump. Care must be taken to ensure that the end of the tube D inside the measuring jar is level with the surface of the water in the water reservoir E. This water surface is maintained at a constant level by running in tap water fast enough to ensure that there is always an overflow even when the pump is being operated. A little water is sucked over into C, by mouth suction, and the tube F connected to the pump while the piston is depressed as far as possible. The piston should now be raised* and the vol. of water drawn over into the jar C measured. The mean of the readings for, say, three separate tests will provide a working measure of the intake of air at each stroke of the pump. To measure the concn. of suspended solids, a clean filter-paper is clamped at A and the inlet pipe B is left open to the atmosphere out of doors.

The piston of the pump is raised and lowered for a number of times, so that air is drawn through the filter-paper.* The exact number of times will depend on the degree of pollution. Ten strokes may be enough if the air is heavily polluted, although 100 may be required if the pollution is light. It is essential that a recognisable stain be produced. The area of the stain should be measured and, from comparison with the standard scale of shades, the weight of deposit determined. Then, since the volume of air drawn through the paper is known, the pollution may be defined in terms of mg per 100 cu.m. of air. For a survey, a number of these estimations should be made at intervals of $\frac{1}{2}$ to 1 mile over the area to be investigated.

The concn. of smoke in any district varies very much from day to day, and even from hour to hour, so that each set of observations should be made in as short a time as possible. Ideally, they should be made on a day of consistent weather, between 11.00 a.m. and 4.00 p.m., since at this time the pollution is generally fairly constant.

In general, it should be noted that the absolute concn. of smoke depends on the rate at which air at ground level is replaced by clean air from above. It is greatest on days when the air is not turbulent, and least on days of high turbulence. If light winds are blowing, the distribution of smoke in a district is most uniform when the air is not turbulent and most closely identified with the distribution of smoking chimneys when it is turbulent. Smoke surveys will therefore provide most information about the general level of smokiness when made on "non-turbulent" days, and most about the location and importance of individual sources of pollution on "turbulent" days. Although the direction of the wind necessarily affects the distribution of smoke, it is not of particular importance in a built-up area.

III. SULPHUR DIOXIDE—There is no simple method available for measuring sulphur dioxide concns. so quickly as deposited or suspended solid matter, although a survey can be carried out over a period of a few months.

The "lead peroxide" method of determining sulphur pollution is described fully in "Investigation of Atmospheric Pollution, Report on Observations in the Year ended March 31st, 1932" (Eighteenth Report) (H.M.S.O., price 5s.). It will therefore be sufficient to say here that a standard surface of lead peroxide is exposed to the open air (but protected from rain) for one month. It absorbs sulphur dioxide in proportion to the concn. in the air, forming lead sulphate. The weight of lead sulphate is estimated chemically.

The lead peroxide method is widely used for routine observations of sulphur pollution. It is also very suitable for making relatively rapid surveys of sulphur dioxide concn. in a district. Instruments should be placed $\frac{1}{2}$ to 1 mile apart, and the measurements continued if possible for 5 summer or 5 winter months. Like smoke, sulphur dioxide varies in concn. from summer to winter, because an appreciable proportion of it is produced by domestic fires.

The Department of Scientific and Industrial Research will be glad to advise local authorities or other bodies which may contemplate making surveys of atmospheric pollution on the choice of appropriate sites or the conduct of such surveys. Any correspondence should be addressed to:

The Secretary, Atmospheric Pollution Research Committee, Department of Scientific and Industrial Research, Teddington, Middlesex.

ABSTRACTS OF PAPERS PUBLISHED IN OTHER JOURNALS

Food and Drugs

Rapid Method for the Estimation of Moisture in Dehydrated Fish. R. Davies and W. E. Isaac (*Nature*, 1944, 154, 211)—The critical temperature of solution method is recommended for the determination of moisture in dehydrated fish. Equilibrium is reached in 30 min. in the extraction of water by boiling 10 g of dehydrated fish with 50 ml of boiling alcohol. Only slightly less water is extracted in 15 min. Robertson (*Ind. Eng. Chem., Anal. Ed.*, 1943, 15, 451; *ANALYST*, 1943, 68, 315) has shown that dicyclohexyl and a mixture of 7 vols. of kerosene and 1 vol. of Standard White Oil No. 7 both possess critical temperatures of solution with water-alcohol mixtures, and the method is sufficiently accurate for food analyses. In this instance, neither dicyclohexyl nor the grades of paraffin recommended by Robertson were available, and a blend of Standard White Oils Nos. 5, 12 and liquid paraffin, approximating in physical characteristics to Standard White Oil No. 7, was used. The critical temp. of solution for alcohol-water mixtures of low, known water content were determined with (a) 7 parts of kerosene and 1 part of blended oil and (b) 3 parts of kerosene and 1 part of blended oil. The ratio of alcohol-water to paraffin mixture was kept const.

at 2:4. The relationships so derived were used as reference curves for all subsequent determinations. It is necessary to draw up the calibration curves for each batch of kerosene and white oil. The following results were obtained on samples from 4 common commercially important South African fish with oil contents on a fresh-weight basis of 0.1 to 3.0%.

Sample No.	Recommended method	Loss in weight	
		Drying <i>in vacuo</i> 20 hr. at 70° C.	Oven drying at 100° C. to const. weight
	%	%	%
1	9.5	—	9.2
2	5.7	5.8	6.0
3	7.7	—	8.1
4	7.8	—	7.5
5	8.55	8.1	8.5
6	9.5	9.4	9.25

J. A.

Determination of Gallic Acid added to Fats and Oils—K. F. Mattil and L. J. Filer, junr. (*Ind. Eng. Chem., Anal. Ed.*, 1944, 16, 427-429)—A preliminary study of the absorption spectrum of gallic acid in aq. soln. showed that the position and height of the absorption peak varied with

* At the top of each stroke, the piston should be kept in position until the pump is completely filled with air, i.e., until there is no longer any pneumatic pull on the handle.

the concn. of gallic acid in soln. In 0.01 N hydrochloric acid ionisation is suppressed and the maximum absorption is independent of the concn. The absorption curve showed a minimum value at 238–239 μ and a maximum value at 270–271 μ . When aliquots of a standard soln. of gallic acid were diluted to different concns. in 0.01 N hydrochloric acid, their optical densities at 270 μ varied directly with the concn. in the range 0.005–0.016 mg per ml. The molecular extinction coefficient was calculated to be

	Saturated						Unsaturated					
	C ₁₂	C ₁₄	C ₁₆	C ₁₈	C ₂₀	C ₂₂	C ₁₄	C ₁₆	C ₁₈	C ₂₀	C ₂₂	C ₂₄
Seal oil	0.1	5.1	10.7	1.3	0.5	0.1	1.8	10.5	39.6	17.6	10.6	2.1
Antarctic whale oil ..	0.2	9.3	15.6	2.8	0.3	—	2.5	14.4	35.2	13.6	5.9	0.2
Arctic whale oil ..	—	4.1	10.6	3.5	—	—	—	18.4	32.8	19.3	11.3	—

9847 on the basis of a molecular wt. of 170.1 for gallic acid by the equation $\epsilon = d/CL$, where d is the optical density, C the concn. in mol. equiv. per litre and L the thickness of the soln. in cm. A colorimetric method for the determination of gallic acid is based on measurement of the colour developed by ferrous tartrate with polyphenolic compounds (Mitchell, ANALYST, 1923, 48, 2; Glasstone, *Id.*, 1925, 50, 49) and with appropriate modifications the method should be applicable to other polyphenolic compounds. To an aq. soln. of the gallic acid sample add 2 ml of a freshly prepared soln. of 0.05% of sodium potassium tartrate and 0.1% of ferrous sulphate, then 10 ml of 10% ammonium acetate soln. to maintain the pH at 7.0, and dilute to 100 ml. The violet soln. shows maximum absorption in the Beckmann spectrophotometer at 540 μ . The relationship between the concn. of gallic acid and the intensity of the colour (measured in an Evelyn photoelectric colorimeter with a 540 μ filter) is linear for concns. between 0.2 and 1.0 mg per 100 ml. The slope of the resulting best straight line (K), calculated by the method of least squares, was found to be 0.325 ± 0.006 , and the concn. of gallic acid is then given by $C = L/K$, where $L = \log 100 - \log G$ (G being the galvanometer reading of the sample soln. when the reading for the reagent blank is 100). The violet colour develops rapidly and is stable for several hr. The intensity of the colour is not affected by addition of twice the stated amount of reagent or by addition of a drop of conc. ammonia soln. To extract gallic acid from fats, to which it is added as an anti-oxidant, treat 5–10 g with 65 ml of water, heat the mixture to b.p., cool, filter through wetted filter-paper, and wash the paper with 20 ml of water in 4 portions. For the spectrophotometric method, dilute the filtrate to 100 ml; for the colorimetric method add the colour reagent and the buffer soln. before diluting to 100 ml. If the concn. of gallic acid is too high (exceeding 1 mg per 100 ml in the colorimetric method and 1.6 mg per 100 ml in the spectrophotometric method) dilute the soln. and take suitable aliquots for the determinations. A. O. J.

Component Acids of Seal Oil. F. Burke and H. Jasperson (*J. Soc. Chem. Ind.*, 1944, 63, 245)—The fatty acids, free from unsap. matter, obtained from blubber oil from the seal family (*Phocidae*) were separated into two groups by titration of a hot soln. in acetone with 4 N aq. lithium hydroxide, the vol. of soln. being then adjusted to give a 95% acetone solvent (*cf.* Hilditch and Maddison, *J. Soc. Chem. Ind.*, 1942, 61, 169; *Abst.*, ANALYST, 1943, 68, 283). Fatty acids from the insol. lithium

salts were separated by the lead salt and alcohol method (*cf.* Hilditch, "Chemical Constitution of Natural Fats," 1940, pp. 371, 401). The composition of the fatty acids is calculated from the results of fractional distillation of the methyl esters of each group of acids. The oil contains the usual range of acids, from 14 to 24 carbon atoms, found in fish and other marine animal oils; also traces (0.1%) of lauric acid. The composition (weight %) of these component acids, as compared with those of whale oils, was

The Wijs iodine value of the seal oil (135.8) lies between those of the average Antarctic (105–120) and Arctic whales (140–150). The higher unsaturation of seal oil, compared with that of Antarctic whale oil, is attributed to its greater percentage of unsaturated C_{20–24} groups and lower content of myristic and palmitic acids. Oils of the *Phocidae* family, as well as those of the *Balaenidae* family, may be characterised by their comparatively high content (35–45%) of C₁₈ unsaturated acids. Bromination and oxidation results for C₁₈ acids give evidence of the presence of oleic and octadecatetraenoic (stearidonic) acid, but not of linolic or linolenic acid, in seal oil. Characteristics of the oil were: sap. equiv. 295.5, unsap. matter 0.7%, free fatty acid (as oleic) 1.5%. E. B. D.

Distinctive Test for Sulphadiazine. H. W. Raybin (*J. Amer. Pharm. Assoc.*, 1944, 33, 158–159)—Heat about 0.1 g of sulphadiazine in a small test tube over a low flame until it melts and a sublimate of 2-aminopyrimidine appears. Dissolve a few mg of the sublimate in 1 ml of a 5% alcoholic soln. of resorcinol and add 1 ml of conc. sulphuric acid. The temp. rises to ca. 75° C. and a deep red colour is produced; neutralise the reaction product with ammonia after dilution with 25 ml of ice-water; this changes the colour to blue with a reddish tinge. The test is very delicate, the red colour being obtained with 0.01 mg of 2-aminopyrimidine, hence the material from the m.p. determination of sulphadiazine may be used by heating the m.p. tube over a tiny flame to obtain the sublimate, cutting off the portion of the tube containing the sublimate, crushing it in a test tube and applying the test. The following sulphonamides give negative results: sulphanilamide, sulphapyridine, sulphathiazole, 4-methylsulphathiazole, sulphaguanidine, sulphacetamide, sulphasuxidine, 4-methylsulphadiazine, 4:6-dimethylsulphadiazine and sulphapyrazine, the *p*-isomer of sulphadiazine. Sulphanilamide formaldehyde sulphonylate gives red resinous ppts. of the phenol formaldehyde type but no change to a blue colour is obtained with ammonia. The test must be used with due regard for other known colour reactions of resorcinol with various compounds, but with sulphadiazine, its m.p. (252/6° C.), that of the 2-aminopyrimidine (126/7° C.), and the colours in the test provide conclusive identification. J. A.

Estimation of Thiouracil in Urine. A. B. Anderson (*Lancet*, 1944, 247, 242)—The method of Danowski (*J. Biol. Chem.*, 1944, 152, 201) for the estimation of thiourea in urine by means of Grote's reagent (*J. Biol. Chem.*, 1931, 93, 225) is applicable to the estimation of thiouracil. To 10 ml of urine,

which may be preserved with chloroform, previously diluted 25-fold with water, add 1 ml of diluted Grote's reagent, leave for 1 hr. and measure the intensity of the bluish-green colour by means of a photoelectric colorimeter with a Chance glass red filter. A standard curve is obtained by subjecting standard solns. of thiouracil containing 1, 2 and 3 mg per 100 ml to the test, 10 ml of each soln. being used. With the specified filter, a straight line is obtained with solns. containing from 0.5 to 4.0 mg of thiouracil per 100 ml. The reagent is not stable, and a curve must be prepared for each batch of estimations; fresh reagent must be prepared after 10 days. A number of pathological urines not containing thiouracil have been tested after dilution 10-fold, and in no instance has any blue or green colour been observed. J. A.

Rapid Estimation of Penicillin. A. Goth and M. T. Bush (*Ind. Eng. Chem., Anal. Ed.*, 1944, 16, 451-452)—Actively growing *Staphylococcus aureus* cultures produce nitrite from nitrate. Production of nitrite is inhibited in presence of penicillin and, within certain limits, decrease in nitrite formation is a function of the concn. of penicillin. The amount of nitrite produced can be determined colorimetrically, and when a standard soln. of calcium penicillin is tested together with the unknown culture the anti-staphylococcal activity of the unknown culture can be expressed in Oxford units. The strain of *Staphylococcus aureus* used was isolated from human septicaemia. **Procedure**—Grow the test strain for 24 hr. on medium No. 1 (containing 2% of Difco peptone and 0.6% of sodium chloride). Add the culture to ice-cold medium No. 2 (containing 2% of Difco peptone, 0.6% of sodium chloride, 0.020% of sodium nitrate and 0.05% of *p*-aminobenzoic acid) to make a 1 to 4 suspension. Plunge the suspension into ice-water and, after swirling, leave on ice for 10-15 min. Meanwhile dilute the standard soln. of penicillin and the unknown solns. with 0.05 molar phosphate buffer soln. (containing equal vols. of 0.05 molar mono- and dibasic sodium phosphate solns.) to contain 0.5-1.0 Oxford units per ml. Pipette 1 ml of each soln. in duplicate into 50-ml Erlenmeyer flasks and 1 ml of buffer soln. into each of 3 control flasks. Add 5 ml of the ice-cold *Staphylococcus* suspension to the contents of each flask and, after moderate shaking, incubate the flasks at 37° C. After 60-90 min. cool one control flask in ice-water and determine the concn. of nitrite by the method of Shinn (*Ind. Eng. Chem., Anal. Ed.*, 1941, 13, 33) with the modification that *p*-aminobenzoic acid is used as primary standard instead of sulphanilamide. If the concn. of sodium nitrite is 5-8 mg per 100 ml remove all the flasks from the incubator, shake, and immediately cool in ice-water. Pipette 0.5 ml of the soln. to be tested into a test-tube, add 5 ml of water and 1 ml of 15% trichloroacetic acid. Shake the tubes and, after 3 min., add 0.5 ml of a 0.1% soln. of *N*-(1-naphthyl)-ethylenediamine dihydrochloride. After a further 3 min. add 3 ml of water and measure the intensity of the colour in a photoelectric colorimeter with a Cenco green filter No. 525P. To prepare the calibration curves, treat 0.5-ml portions of standard solns. containing 0.5, 1, 2, 5, and 10 mg of *p*-aminobenzoic acid per 100 ml with 5 ml of water, 1 ml of 15% trichloroacetic acid and 0.5 ml of 0.1% sodium nitrite soln. Shake the tubes and, after 3 min., add 0.5 ml of 0.5% ammonium sulphamate soln. and, after 2 min., 0.5 ml of 0.1% *N*-(1-naphthyl)-ethylenediamine dihydrochloride

soln. and 3 ml of water. Read the intensity of the colour in the colorimeter. To obtain the concn. of sodium nitrite in the cultures, the values for *p*-aminobenzoic acid are multiplied by 0.5, i.e., by the ratio between the mol. wts. of sodium nitrite and *p*-aminobenzoic acid. A. O. J.

Biochemical

Use of Dyes for the Determination of Acid and Basic Groups in Proteins. H. Fraenkel-Conrat and M. Cooper (*J. Biol. Chem.*, 1944, 154, 239-246)—Acid and basic dyes are known to combine with protein groups of opposite ionic charge, and a method for determining the total acid and basic groups of proteins is based upon this ability to combine with dyes in buffered alkaline or acid solns.; the uncombined dye is estimated by means of a photoelectric colorimeter. The method is applicable to both soluble and insoluble proteins. Into each of four 15-ml test-tubes put 5 mg of the protein, 1 ml of pH 2.2 buffer soln. (980 ml of 0.1 *M* citric acid soln. and 20 ml of 0.2 *M* disodium phosphate soln.), increasing amounts (1, 2, 3 or 4 ml) of 0.1% orange G soln. and two glass beads. Shake mechanically for 20-24 hr., centrifuge and dilute aliquot portions of the supernatant solns. 100-fold. Measure the colour intensities in a Klett-Summerson photoelectric colorimeter using the blue filter (Corning No. 038 + Pyrex No. 554), and calculate the concn. of dye from a standard curve obtained with appropriate dilutions of a stock soln. of orange G. Instead of a curve there is a straight line in the range 0.5-10 mg of dye per litre. Subtract the amount of uncombined dye thus determined from the amount of dye originally added, both expressed in mg/litre, multiply the result by 8.85 to obtain the number of acid equivalents of dye bound per g. of protein $\times 10^4$. This factor 8.85 is derived from the expression:

$$\frac{\text{valency of the dye (2)} \times 10}{\text{molec. weight of dye (452)} \times \text{amount of protein (0.005 g)}}$$

To determine acid groups use the same procedure with a pH 11.5 buffer (250 ml of 0.2 *M* disodium phosphate soln. and 200 ml of 0.1 *N* sodium hydroxide diluted to 1 litre) and a 0.2% soln. of safranine O. Measure the colour intensities with the blue filter used for orange G. The standard curve becomes a straight line from 0 to 10 mg of dye per litre. The factor required to convert the results into base equivalents of dye bound per g of protein $\times 10^4$ is 5.62. With proteins soluble in either of the buffer solns., 1.5-mg samples of the protein are sufficient. The number of protein groups bound to the dyes was found to correspond well with the total number of basic (guanidyl, imidazole, amino) and acidic (carboxyl, phenol, thiol) groups of crystalline egg albumin and lactoglobulin. F. A. R.

Composition of Casein in Milk. G. A. Ramsdell and E. O. Whittier (*J. Biol. Chem.*, 1944, 154, 413-417)—The caseinate-phosphate complex of milk was separated from other milk constituents by means of the Sharples centrifuge and analysed as follows. Nitrogen was determined by the semimicro-Kjeldahl method, using 30 mg of material and a digestion time of 8 hr. (*cf.* Chibnall *et al.*, *Biochem. J.*, 1943, 37, 354). Calcium was determined in the ash by the official macro-permanganate method (*A.O.A.C. Methods*, 1940, p. 127), and total phosphorus by the official gravimetric

method. Inorganic phosphorus was obtained from the trichloroacetic acid filtrate and determined by the strychnine gravimetric method of Embden and Fetter (Peters and Van Slyke, *Quantitative Clinical Chemistry Methods*, 1932, 875). Organic phosphorus was calculated by subtracting the inorganic from the total phosphorus. Moisture was determined by heating in a vacuum oven at 105° C. to constant weight, and carbon and hydrogen by Clark's method (*J. Assoc. Off. Agr. Chem.*, 1933, 16, 413), using a semimicro combustion furnace. Sulphur was determined by the official sodium peroxide fusion method. To determine whether the inorganic phosphate was present as the tri- or dibasic compound, neutral potassium oxalate was added to the complex and the change in pH was measured. It was observed that the mixture became much more alkaline, showing that the phosphate was present as calcium triphosphate in accordance with the following equation:



Had the calcium salt been the dibasic compound, an equivalent amount of K_2HPO_4 would have been formed, and the pH would therefore have remained constant. By measuring the increase in alkalinity by titration, the amount of $\text{Ca}_3(\text{PO}_4)_2$ present was found to be 4.81%, in excellent agreement with the value of 4.80% found by analysis. By difference, therefore, the complex contained 95.2% of calcium caseinate. It seems unlikely that the calcium phosphate is bound chemically to the calcium caseinate, since complexes isolated by different procedures were found to contain slightly different proportions of phosphate and caseinate. The following values were obtained for the composition of calcium caseinate: Ca, 1.18; P, 0.78; N, 15.34; C, 52.29; H, 6.92; S, 0.76; O (by diff.) 22.73%.

F. A. R.

Determination of *p*-Aminobenzoic Acid by Assay with *Clostridium acetobutylicum*. J. O. Lampen and W. H. Peterson (*J. Biol. Chem.*, 1944, 153, 193-202).—From a stock culture of *Clostridium acetobutylicum* Strain S9, carried on sterile soil, inoculate a medium consisting of glucose, ammonium phosphate, ammonium acetate and salts (all at half the concns. given in the table below), and 0.5% peptone. After 24-30 hr. incubation, add 4 drops of the culture to a tube containing 5 ml of basal medium, 5 mg of reduced iron and 0.005 μg of *p*-aminobenzoic acid, and dilute to 10 ml. When 18 to 24 hr. old, add one drop of this culture to each assay tube. The basal medium (pH 6.7 \pm 0.1) is as follows:

Glucose 4.0 g/100 ml
 $(\text{NH}_4)_2\text{HPO}_4$ 0.2 g/100 ml
 Ammonium acetate 0.4 g/100 ml
 Salt mixture* 0.2 g/100 ml
 "PAB-free" casein hydrolysate, 1.0 ml/100 ml
 Cystine 20 mg/100 ml
 Tryptophan 15 mg/100 ml
 Biotin 0.2 μg /100 ml
 $\text{Na}_2\text{S}_2\text{O}_4 \cdot 2\text{H}_2\text{O}$ 10 mg/100 ml

To prepare the "PAB-free" casein hydrolysate, heat 100 g of vitamin-free casein under reflux for 20 hr. with 1 litre of 20% hydrochloric acid. Concentrate *in vacuo* to a thin syrup, add 300 ml of water, and again concentrate. Repeat twice and

* Salt mixture: K_2HPO_4 , 10 g; KH_2PO_4 , 10 g; $\text{MgSO}_4 \cdot 7\text{H}_2\text{O}$, 4.0 g; NaCl, 0.2 g; $\text{MnSO}_4 \cdot 4\text{H}_2\text{O}$, 0.2 g; $\text{FeSO}_4 \cdot 7\text{H}_2\text{O}$, 0.2 g.

then adjust to pH 4 with sodium hydroxide soln. and dilute to 1 litre. Stir 100 ml of the hydrolysate with 2 g of Norit for 30 min. on the steam-bath, cool and filter. Adjust the filtrate to pH 2 with sulphuric acid, and extract with ether continuously for 24 hr. Into each of a series of bacteriological test-tubes put 5 mg of reduced iron, and then add appropriate aliquots of the material to be assayed or a standard PAB soln. Dilute to 5 ml and add 5 ml of the basal medium. Autoclave for 15 min. at 15 lb., cool and inoculate as above. Prepare an anaerobic jar by filling a suitable container one-quarter full of oats, and adding enough water to cover the oats. Put the assay tubes in the jar and seal the glass top with plasticine. The respiration of the oats removes the oxygen and establishes a partial pressure of carbon dioxide. Incubate at 37° for 20-24 hr. Measure the turbidity of the tubes in an Evelyn photoelectric colorimeter with a 660 μ filter against the uninoculated basal medium set at 100. Calculate the results from a standard curve obtained with standard solns. of PAB containing from 0.3 to 1.5 millimicrograms per tube. The method is highly specific and the error is about \pm 10%. Natural materials should first be hydrolysed to liberate PAB, and for this purpose autoclaving at 75 to 80 lb. for 1 hour in 5 N sodium hydroxide is recommended; acid hydrolysis liberates only part of the PAB.

F. A. R.

Component Fatty Acids of Early and Mature Human Milk Fat. A. R. Baldwin and H. E. Longenecker (*J. Biol. Chem.*, 1944, 154, 255-265)—

The lipid material was extracted from dried samples of colostrum and mature milk first with ethanol and then with ethyl ether and the phospholipids were then separated by pptn. with acetone and magnesium chloride. The total lipid and phospholipid content of whole milk on the 1st-2nd, 3rd and 22nd-43rd days was found to be 2.2, 2.3, 3.2 and 0.8, 0.2, 0.06% respectively. The acetone-soluble lipids from the milk samples were saponified and the resulting fatty acids were separated into volatile and non-volatile acids by steam distillation. The amounts of each acid were then estimated by fractional distillation of the methyl esters in the usual way. The results obtained with 1st-2nd day, 3rd day and mature milk are within the ranges in the following table:

Acid	Weight, %	Molar percentage
Butyric	0.2-0.4	0.7-1.1
Caproic	0.1	0.1-0.3
Caprylic	0.1-0.8	0.1-1.5
Capric	0.9-3.5	1.4-5.3
Lauric	0.9-5.5	1.2-7.1
Myristic	2.8-8.5	3.3-9.6
Palmitic	23.2-27.8	23.4-28.9
Stearic	6.9-9.9	6.3-9.2
As arachidic ..	1.1-4.9	0.9-4.1
Decenoic	0.1-0.2	0.1-0.3
Dodecenoic ..	0.1	0.1
Tetradecenoic ..	0.1-0.6	0.1-0.7
Hexadecenoic ..	1.8-3.0	1.9-3.0
Octadecenoic ..	36.0-37.1	33.3-35.1
Octadecadienoic ..	6.2-7.8	5.3-7.2
Octadecatrienoic ..	0.3-0.4	0.2-0.4
Eicosatetraenoic ..	0.9-1.8	0.8-1.5
As Eicosadienoic ..	2.4-4.7	2.0-4.0

Only slight differences were observed in the amounts of individual acids in milk obtained on the 1st-2nd days as compared with 3rd-day and mature milk. The amount of low molecular weight fatty acids

is very small in comparison with cow's milk fat. The colostrum fat contained relatively large amounts of C_{20} and C_{22} acids and these decreased as the postpartum period lengthened, whilst the amounts of C_{12} and C_{14} acids increased.

F. A. R.

Interfering Substances in the Determination of Phosphoglycerol. G. A. LePage (*J. Biol. Chem.*, 1944, **152**, 593-597)—Leva and Rapoport (*J. Biol. Chem.*, 1943, **149**, 47; ANALYST, 1943, **68**, 377) recently described a method for the estimation of phosphoglycerol by oxidising to phosphoglycol aldehyde with periodate and hydrolysing the product with acid. Expts. have now indicated that ribose-5-phosphate, fructose-6-phosphate and glucose-6-phosphate interfere with the determination of phosphoglycerol by this method. No satisfactory method of overcoming the difficulty has yet been devised.

F. A. R.

Improved Thiochrome Method for the Determination of Aneurine in Urine. V. A. Najjar and K. C. Ketron (*J. Biol. Chem.*, 1944, **152**, 579-584)—Najjar and Wood (*Proc. Soc. Exp. Biol. Med.*, 1940, **44**, 386) reported the presence in urine of a nicotinic acid derivative ("substance F_2 ") which was adsorbed and eluted together with aneurine, and exhibited a greenish-blue fluorescence when the soln. was made alkaline and then extracted with isobutyl alcohol. Interference by this contaminant cannot be avoided merely by making a blank determination, using alkali alone instead of alkali + ferricyanide and subtracting the value of the blank from that of the sample treated with ferricyanide, since substance F_2 is oxidised by ferricyanide to a pyridone which possesses 21% of the fluorescence of the original substance. Nor could the error due to the presence of substance F_2 be eliminated by carrying out a blank determination on a sample treated with sodium sulphite to destroy aneurine, as suggested by Mason and Williams (*J. Biol. Chem.*, 1942, **146**, 589), because some of the substance F_2 is also destroyed by sulphite. The following method, in which a correction is applied for the reduction of the fluorescence of substance F_2 caused by the oxidation with ferricyanide, offers a satisfactory procedure. Adsorb a sample of urine (5 to 25 ml) containing not less than $3\mu\text{g}$ of aneurine on a column of freshly activated Permutit. Elute the column with 25% potassium chloride soln. until 11 ml of eluate have collected. To two 5-ml portions of the eluate add 3 ml of 15% sodium hydroxide soln., and to one of them add in addition 0.1 ml of 1% potassium ferricyanide soln. Immediately extract each soln. with 13 ml of isobutyl alcohol by vigorously shaking for 1 to 2 min., and then centrifuge for 3 min. at low speed. Separate the isobutyl alcohol layer, add a little anhydrous sodium sulphate and measure the fluorescence without delay. Compare the fluorescence with that of a soln. of $1\mu\text{g}$ of aneurine chloride in 5 ml of potassium chloride soln. treated with alkali and ferricyanide and extracted with isobutyl alcohol in the same way.

$$\text{Aneurine } (\mu\text{g}) = \frac{(AF - B) - 0.21(A - B)}{(T - B)} \times \frac{11}{5}$$

in which A and AF represent the fluorescence (in galvanometer units) of the aliquots treated with alkali and alkali + ferricyanide respectively, B represents that of the reagent blank, and T that of the aneurine standard in these same units. The factor 0.21 is the correction factor required for assessing the fluorescence of the oxidised substance F_2 . In practice a quinine soln. is used for standard-

ising the instrument each time an estimation is made, the quinine standard being standardised first against an aneurine standard. The method gives an accurate assay of aneurine even in presence of an excess of substance F_2 , the recoveries being very close to the theoretical, whereas when no correction for the oxidation of substance F_2 is introduced, recoveries are very incomplete.

F. A. R.

Effect of Caramelised Fructose on the Stability of L-Ascorbic Acid. W. E. Isaac (*Nature*, 1944, **154**, 269-270)—It has been shown (Isaac, *Ind. Eng. Chem.*, 1943, **35**, 470) that the caramelisation of lemonade powders at high storage temperatures is due to fructose formed from sucrose through hydrolysis of the latter by the water liberated from citric acid crystals. Further, darkening in colour and loss of ascorbic acid are associated changes in orange juice concentrate. Since fructose caramelises spontaneously at temps. above 98° F., its effect on the deterioration of foodstuffs in warm climates may be important. Samples of fructose which had caramelised on keeping, together with pure fructose prepared by recrystallisation from alcoholic solns. which had been treated with charcoal until colourless, were tested by making 10% solns., each containing 50 mg of ascorbic acid per 100 ml. The solns. (ca. 24 ml) were stored in 50-ml bottles at ca. 10° C., thus ensuring the presence of excess of oxygen above that required to oxidise the whole of the ascorbic acid in each bottle. Ascorbic acid was estimated by titration with 2:6-dichlorophenol-indophenol, which was not reduced by the samples of caramelised fructose used. This is in contrast with the products of caramelisation brought about by action of alkali (Harris, *Nature*, 1933, **132**, 27). All glassware and materials other than fructose and ascorbic acid were sterilised. The following table summarises the results of storage under aerobic conditions:

Days	Loss of ascorbic acid %	
	Pure fructose	Caramelised fructose
2	3.1	32.9
5	—	46.6
7	12.3	—
8	—	68.5
10	18.65	75.2
14	20.3	—
17	31.0	100.0

The results obtained under anaerobic conditions are not sufficiently precise to merit detailed statement, but the destructive effect is definitely present, although the rate of destruction is very much less. Further, there are wide differences in the rate of destruction brought about by different samples of caramelised fructose under anaerobic conditions.

J. A.

Forensic

Staining of the Cuticular Scales of Hair. J. Davidson and W. D. Taylor (*J. Quekett Microsc. Club*, 1943, iv, I, 289-293)—In the identification of hair, factors to be considered are the length of the hair, the general appearance of the cuticular scales, the cortex in relation to the proportion of area it occupies and its pigment granules, the shape of the cells and the extent of the medulla, and, by examination of the transverse section, the shape of the contour and the size and position of the medulla relative to the cortex. The observation of the

cuticular scales may be difficult in many types of hair, and methods of making a cast of them on a plastic film have been evolved (Smith and Glaister, "Recent Advances in Forensic Medicine," 2nd Ed., p. 110; Glaister, "Medical Jurisprudence and Toxicology," 7th Ed., p. 112; Hardy, *Fugitive Bulletin*, U.S.A., Dec., 1934; Stoves, *ANALYST*, 1942, 67, 385). The difficulties inherent in these methods are overcome by the following procedure, whereby the scales are stained. The medulla is rendered transparent by placing the hairs in distilled water in a vacuum embedding oven at room temperature at a pressure of 18–30 mm of mercury for 2 hr. It is established that the opacity is due entirely to air and, to facilitate its removal and prevent distortion or even rupture of the scales, it is advisable to cut each end of the hair before immersing it in water. Bleach heavily pigmented human and animal hairs by immersion in a mixture consisting of 50 ml of hydrogen peroxide (30 vol.) and 1 drop of 5% ferric chloride soln. to which has been added an excess of ammonia soln. just before use. The time of immersion varies from 15–30 min. for fair human and white animal hairs to 12 hr. for heavily pigmented hairs (e.g., black horse). It is important that the hair should be removed before it softens; usually this does not take place until it has been rendered transparent. Wash the bleached hair and stain in dil. (1 in 100) carbol fuchsin (Ziehl-Neelsen) at room temp. in a vacuum embedding oven at a pressure of 18–30 mm of mercury for not less than 15 min. Wash, decolorise and dehydrate in abs. alcohol for 5–10 min., clear in benzene and mount in Canada balsam. A hair so prepared gives three optical sections on examination, viz., cuticular scales on the upper surface, cuticle, cortex and cellular structure of the medulla, and cuticular scales on the under surface of the hair. No difficulty in taking photographs has been encountered, provided that suitable plates and filters are used. J. A.

Water

Measurement of Potential Difference as a Method for Studying the Action of Water on Lead Pipes. W. R. G. Atkins (*Nature*, 1944, 154, 211–212)—The diverse chemical factors affecting the action of water on lead appear to be summed up by a measurement of the difference of electrical potential between old and new lead surfaces immersed in the sample. Thresh has shown (*ANALYST*, 1922, 47, 457, 500; 1924, 49, 270) that acidity or alkalinity is of minor importance, but the presence of lime with a silicate or organic acid, such as citric, lessens the action. Since differences of a few millivolts were found between different old lead surfaces, the gold electrode was used in measuring the potential difference between gold and old or new lead surfaces. The following results are quoted, the units being millivolts between gold and lead surfaces at a temp. of ca. 12° C.

It is pointed out that the treatment of town water supply with silicate is effective, as the new lead surface is rapidly inactivated. J. A.

Determination of Small Amounts of Tannin in Water. J. Haslam, J. S. Wilson and J. E. Edwards (*J. Soc. Chem. Ind.*, 1944, 63, 179–182)—The following modification of Berk and Schroeder's test (*Ind. Eng. Chem., Anal. Ed.*, 1942, 14, 456) is recommended as a field method of determining tannin in hard waters. Place 25 ml of the sample in a 50-ml Nessler tube, add 1 ml of Folin-Denis soln. (prepared by adding 750 ml of water to 100 g of sodium tungstate, 20 g of phosphomolybdic acid and 50 ml of 85% phosphoric acid, boiling gently for 2 hr., cooling to 25° C., and making up to 1 litre), followed by 2 ml of hexametaphosphate soln. (25 g of Calgon dissolved in 100 ml of water, and filtered if not quite clear). After 5 min. add 20 ml of sodium carbonate soln. (15 g of sodium carbonate A.R. dissolved in 100 ml of water and filtered if not quite clear). After 10 min. the unknown is compared in a Bolton-Williams photometer with the standards prepared at the same time and in the same way; a cell containing copper sulphate soln. is inserted in the light beam to limit the spectrum range of the light. The standard is prepared by dissolving 1 g of tannin in 100 ml of water, diluting 10 ml of this soln. to 1000 ml, and then further diluting 1 ml of the second soln. to 50 ml; the soln. then contains 2 p.p.m. of tannin. The standard should be prepared with the same tannin as has been used in the water-treatment chemical. Sulphites, nitrites, ferric salts and silicates are almost without influence, but phenolic substances, sulphides and ferrous salts interfere; the test may be carried out in their presence by the subtraction of a blank determined on a sample of water before addition of the tannin, or by the use of the untreated water for the preparation of the standards, provided that the blank value of the untreated water is low compared with that of the tannin-treated samples. Whilst some waters were almost free from interfering substances, others, used industrially, contained comparatively large proportions of interfering phenolic matter. E. M. P.

Agricultural

Determination of Nitrate, Nitrite and Ammonium Nitrogen in Soil and Plant Extracts. B. Wolf (*Ind. Eng. Chem., Anal. Ed.*, 1944, 16, 446–447)—The reagents required are 1% brucine soln. in conc. nitrate-free sulphuric acid, a 10% v/v dimethylaniline soln. in hydrochloric acid (1+6), Graves's reagent, made by dissolving 80 g of sodium chloride in 130 ml of water, adding 100 ml of sat. mercuric chloride and 70 ml of sat. lithium carbonate soln. in small amounts at a time with continual shaking and filtering after adding 5 g of talc. Graves's soln. is stable in a brown bottle for several

Sample	pH	Period of immersion					
		2 min.		10/40 min.		ca. 1 day	
		Old	New	Old	New	Old	New
Distilled	6.0	617	625a	—	—	—	—
River	5.8	584	682	537	581	472	476–505b
River, with silicate	8.0	507	506	—	—	—	—
Lake	7.3	514	556	390	396	282	390

a Obtained indirectly, 108 millivolts more than old surface.

b After stirring.

weeks, but must be shaken well before use. Morgan's extracting soln. is 0.5 *N* acetic acid buffered at pH 4.8 with sodium acetate. For the nitrate nitrogen standard soln., dissolve 0.0910 g of sodium nitrate in 1000 ml of extracting soln. (15 p.p.m.); for the nitrite nitrogen standard soln., 0.1210 g of potassium nitrite in 1000 ml of extracting soln. (20 p.p.m.); for the ammonium nitrogen standard soln., 0.1521 g of ammonium chloride in 1000 ml of extracting soln. (40 p.p.m.). Calibrate the electrophotometer with aliquots of the standard solns. diluted with extracting soln. to appropriate vols. Prepare the soil and plant extracts by the methods described by Wolf (*Ind. Eng. Chem., Anal. Ed.*, 1943, 15, 248). To determine nitrate nitrogen in absence of nitrite, dilute the extract (2.5 ml) to 15 ml with extracting soln., add 7.5 ml of brucine reagent cautiously down the side of the tube, stir immediately and, after 15 min., take photometer readings, using a 425 blue filter and adjusting the blank reading to 100. In presence of nitrite nitrogen treat standard amounts of nitrite (0.1–1.0 p.p.m. of nitrogen) with brucine reagent and draw a standard curve from the data. The amount of nitrate nitrogen equiv. to the known amount of nitrite nitrogen present is calculated from the standard curves and deducted from the total nitrate and nitrite nitrogen indicated by the brucine reaction. A less exact method is to deduct 3 p.p.m. of nitrate nitrogen from the total amount found by the brucine test for each p.p.m. of nitrite nitrogen known to be present. (With the brucine reagent nitrite is ca. 3 times as effective as nitrate.) To determine nitrite nitrogen add 0.5 ml of dimethylaniline soln. to 10 ml of extract diluted to 20 ml with extracting soln., stir, add 1 ml of conc. hydrochloric acid, stir again and, after 15 min., take photometer readings as before. For ammonium nitrogen, dilute 5 ml of extract to 20 ml with extracting soln., add 0.2 ml of 0.25% gum arabic soln., mix thoroughly, add 0.5 ml of Graves's reagent, mix, add 3.5 ml of 15% sodium hydroxide soln., and mix thoroughly and immediately. After 5 min. take photometer readings. The nitrite content of many soil and plant extracts is small enough to be ignored. When present, its effects can be eliminated by addition of sodium azide, but it is simpler to compensate for it in the manner described. A. O. J.

Organic

Determination of Carbon-linked Methyl Groups. W. F. Barthel and F. B. LaForge (*Ind. Eng. Chem., Anal. Ed.*, 1944, 16, 434–435)—In the investigation of pyrethrolone the carbon-linked methyl content of fractions and derivatives was determined by a modification of the method of Pregl (*"Quantitative Organic Microanalysis,"* 3rd Ed., p. 201, Philadelphia, 1937), which is essentially that of Kuhn and L'Orsa (*Z. angew. Chem.*, 1931, 44, 847) based on oxidation of the substance with chromic acid and titration of the resulting acetic acid. Although, in general, straight chain compounds give the theoretical yield of acetic acid, other groupings, e.g., a single methyl group attached to an aliphatic ring, usually yield less than the theoretical amount, and the result must be compared with that given by a reference compound. Where more than one methyl group on the same carbon atom is involved, or where methyl groups are attached to aromatic rings, the method is of doubtful value. The changes made in the original details are the use of Clark's apparatus for

semi-micro determinations of the acetyl group (*Ind. Eng. Chem., Anal. Ed.*, 1936, 8, 487) and the omission of the reduction of the excess of chromic acid with hydrazine. To 20–30 mg of sample (weighed on cigarette paper if solid and in a glass capsule if liquid) in a distillation flask with an upward inclined side tube add 5 ml of an oxidising soln. made by adding 20 ml of conc. sulphuric acid to 16.8 g of chromic anhydride dissolved in 100 ml of water. Place a finger condenser in the neck of the flask and heat the mixture with a small flame for 1.5 hr. Remove the finger condenser, rinsing it with a very small amount of water, add 7 g of magnesium sulphate to the contents of the flask and steam distil, using a burner under the flask to concentrate the liquid while 50 ml of distillate are collected. Titrate the distillate with 0.05 *N* barium hydroxide to the neutral point of phenolphthalein. An additional 5 ml of distillate should not affect the end-point appreciably. Make a blank determination in the same manner with the organic substance omitted. If sulphuric acid accidentally appears in the distillate (as will be indicated by the barium hydroxide soln.), the determination must be repeated. The Elek and Harte iodimetric procedure (*Ind. Eng. Chem., Anal. Ed.*, 1936, 8, 267) may be used with good results and has the advantage of correcting for any sulphur dioxide carried over. Distillation of sulphur dioxide can be avoided by arranging the steam supply and the burner heat so that concn. of the liquid to charring point does not occur. The terminal methyl number is the number of mol. equivalents of acetic acid produced from 1 mol. equiv. of the compound. The method was applied successfully to the determination of the amount of acetic acid yielded by a number of compounds with terminal methyl groups, which were used as reference compounds in the estimation of the proportions of the two forms of pyrethrolone in mixtures.

A. O. J.

New Reagent for Primary and Secondary Amines. A. J. Birch (*J. Chem. Soc.*, 1944, 314–315)—2-isoNitrosocyclohexane-1:1'-pyridinium chloride reacts with primary and secondary amines to yield 2-isonitrosocyclohexylamines, which can be used to characterise the amines. To prepare the reagent, mix to a paste 11 g of cyclohexene nitroschloride and 20 ml of pyridine and warm cautiously on a water-bath until the exothermic reaction begins, then cool in water. Add 15 ml of alcohol containing 4 ml of water and heat on the steam-bath to produce a clear yellow soln., from which a cream-coloured crystalline ppt. separates on cooling and addition of 15 ml of ethyl acetate. Recrystallise from alcohol-water (30 ml : 4 ml); the chloride forms monohydrated colourless prismatic crystals, m.p. 125° C. As an example of the use of the reagent, add 5 ml of a 10% aqueous soln. of the reagent to 2.5 ml of 10% aq. sodium carbonate soln., mix with an aq. soln. containing 0.2 g (ca. 1 mol.) of dimethylamine hydrochloride and 2.5 ml of 10% sodium carbonate soln., and warm on the steam-bath for 3 min.; there separates an oil which crystallises on cooling. Recrystallised from a mixture of benzene and light petroleum (b.p. 40–60° C.) it forms colourless prismatic needles, m.p. 120° C. The derivatives are not entirely satisfactory, as those from the lower amines are rather water-sol., whilst those from some of the higher amines crystallise slowly, unless seeded; the m.p.'s of adjacent homologues are sometimes

rather close, but the mixed m.p.'s show considerable depression. The following derivatives have been prepared:

Amine	m.p. of derivative
Dimethylamine	120°
<i>n</i> -Propylamine	72
<i>n</i> -Butylamine	81
<i>iso</i> Butylamine	73
<i>tert.</i> -Butylamine	91
Diethylamine	63
Morpholine	118
Piperidine	116*
<i>cyclo</i> Hexylamine	145
<i>n</i> -Heptylamine	66

* Perrot (*Compt. rend.*, 1936, 203, 329) gives m.p. 119° C.

impurities found in the commercial product. When formed in presence of water the dithiocarbamate contains 0.5 mol. of water of crystallisation,

Formula	Analysis	
	found, N %	req., N %
$C_8H_{16}ON_2$	17.9	18.0
$C_9H_{18}ON_2$	16.9	16.5
$C_{10}H_{20}ON_2$	15.8	15.2
"	15.0	"
"	14.9	"
"	15.7	"
$C_{10}H_{18}O_2N_2$	14.0	14.1
$C_{11}H_{20}ON_2$	14.4	14.3
$C_{12}H_{22}ON_2$	13.6	13.3
$C_{13}H_{26}ON_2$	12.3	12.4

E. M. P.

Separation of Methylated Methylglycosides by Adsorption on Alumina. J. K. N. Jones

(*J. Chem. Soc.*, 1944, 333-334)—Tetramethyl methylglycosides can be separated quantitatively from trimethyl methylglycosides by adsorption on activated alumina from soln. in ether and light petroleum. The technique can also be applied to the separation of the components of constant-boiling mixtures, such as a mixture of trimethyl methyl-*l*-arabofuranoside and trimethyl methyl-*d*-xylopyranoside obtained from the distillation of the glycosides from the hydrolysis of methylated damson gum (Hirst and Jones, *J. Chem. Soc.*, 1938, 1178; Hirst, *Id.*, 1942, 70). The procedure is as follows. Stir all solvents with activated alumina, filter and distil. Dissolve a mixture of 3 g of trimethyl methylglycoside and 150 mg of tetramethyl methylglycoside (n_D^{16} 1.4430) in a mixture of 25 ml of ether and 25 ml of light petroleum (b.p. 60-80). Filter through a column of alumina (15 cm × 2 cm) (Peter Spence & Sons, Ltd., Widnes; Grade 100/200 Birlec type) and develop the chromatogram with ether and light petroleum (b.p. 60-80° C.) (2 : 1 mixture by vol.). Collect the filtrate in 20-ml fractions and evaporate on the water-bath. The following products were collected: (1) 3 mg of yellow impurity, (2) 142 mg of a syrup, tetramethyl methylglycoside, yield 94%, n_D^{16} 1.4426 (found, methoxy 61.4, calc. for $C_{11}H_{22}O_6$, methoxy 62%). After hydrolysis with boiling 2 *N* hydrochloric acid this gave crystalline tetramethyl glucopyranose, yield 88%. The third part of the eluate consisted of solvent only, but the following portion contained (3) 174 mg of trimethyl β -methylglycoside, m.p. and mixed m.p. with an authentic sample 60° C., $[\alpha_D^{20}] = -34^\circ$ (c, 1.2 in water). The remainder of the trimethyl methylglycoside was eluted with methyl alcohol. Application of the technique to a study of the repeating unit of methylated banana starch and methylated rice starch showed 33 glucose residues per repeating unit in rice starch and 26 in banana starch, in close agreement with previous results (31 and 26 respectively). E. M. P.

Purification and Gravimetric Determination of 1-Diethylamino-4-Aminopentane. R. G. Jones (*Ind. Eng. Chem., Anal. Ed.*, 1944, 16, 431-432)—1-Diethylamino-4-aminopentane reacts with carbon disulphide to form a stable and insol. dithiocarbamate. The pptn. from acetone soln. containing ca. 2-3% of water is practically quantitative and effects a sharp separation from all the

and when formed in abs. alcohol 0.5 mol. of alcohol of crystallisation. When the pure amine is treated with carbon disulphide in dry alcohol-free ether, the anhydrous dithiocarbamate is formed. All three forms melt with decomposition at 136-138° C. (uncorr.). Both the hemialcoholate and the anhydrous substance are converted into the hemihydrate by treatment with water. The hemihydrate is sol. in water (1.175 g per 100 ml) and in 95% alcohol (0.048 g per 100 ml) at 30° C. In acetone, ether, carbon disulphide or benzene, the solubility is extremely small. Aq. alkali dissolves the dithiocarbamate, and acids decompose it with formation of carbon disulphide. A number of other amines form ppts. with carbon disulphide in acetone soln., e.g., ammonia, piperidine, ethylenediamine, *N,N*-diethylethylenediamine, 2,3-diaminobutane, 1-diethylamino-3-aminopropane, 1-diethylamino-5-aminopentane, putrescine, cadaverine, and presumably all diamines structurally similar to 1-diethylamino-4-aminopentane. None of the common aliphatic monoamines, e.g., methylamine, ethylamine, diethylamine, ethanolamine, or any tertiary amine is pptd. from acetone soln. by carbon disulphide. None of the interfering diamines has been found in commercial 1-diethylamino-4-aminopentane. For the gravimetric determination, treat 1 g of the sample immediately after weighing with 20 ml of acetone previously dried over potassium carbonate and filtered and then with 15 drops (0.75 ml) of water. To the soln. add 10 ml of a 15% v/v soln. of carbon disulphide in acetone. Stir the mixture until pptn. appears complete, leave for 30 min., add 25 ml of acetone and leave again for 30 min. Loosen the ppt. from the sides of the vessel, decant the supernatant acetone through a tared filtering crucible, wash by decantation with two 10-15-ml portions of acetone and transfer the ppt. into the crucible with acetone. Drain as completely as possible by suction, and dry the ppt. over calcium chloride *in vacuo* (5-10 mm) for at least 5 hr. and for not more than 46 hr. (to avoid loss of water of crystallisation). The ppt. has the composition $C_{10}H_{22}N_2S_2 \cdot \frac{1}{2}H_2O$. A. O. J.

Identification of Natural and Synthetic Rubbers. H. P. Burchfield (*Ind. Eng. Chem., Anal. Ed.*, 1944, 16, 424-426)—The method was designed for the identification of soft rubber vulcanisates based on the polymer types represented by natural rubber, Buna S, Buna N, Butyl, Neoprene GN, chloroprene nitrile polymers, polyvinyl chloride and polyvinyl acetate. Distinctions within types

are not possible, and the polysulphide rubbers are not included because they can usually be recognised by odour. The procedure depends upon an approximate determination of the sp.gr. and pH of the products of pyrolysis. When only a few tests are to be made, Pyrex test-tubes (16 × 150 mm) equipped with a condensing arm bent twice at right angles are used, the source of heat being a Bunsen burner. For large-scale testing, an electric furnace controlled at 530–550° C. is preferable. Soln. I contains 0.5 g of cryst. sodium citrate, 1.00 g of citric acid, 0.04 g of thymol blue and 0.10 g of bromothymol blue dissolved in a mixture of 1 litre of methyl alcohol and 210 ml of water. The pH is 4.7 at 25° C. and the sp.gr. is adjusted to 0.850 ± 0.0005 at 25°/4° C. Soln. II contains 2.00 g of sodium citrate and 0.01 g of bromophenol blue dissolved in a mixture of 780 ml of methyl alcohol and 380 ml of water. The pH is 8.4 at 25° C. and the sp.gr. is adjusted to 0.8900 ± 0.0005 at 25°/4° C. Strip the rubber from adhering fabric and heat 1 g in the Pyrex tube. After ca. 1 min. the sample begins to decompose. When droplets of condensate appear in the vertical arm dip the end beneath the surface of 2 ml of soln I in a 10 × 75 mm test-tube. When enough oil has distilled to cover the surface of the liquid replace the tube by a similar tube containing soln. II. Cool the tubes for a few min. and shake them sharply to determine whether the droplets sink or float. Note the colours of the solns. and classify the sample according to the table.

excess of bromine in a current of air, cover the sample with phenol, heat gently for a few min., cool and add 10 ml of chloroform. An opaque purple soln. indicates natural rubber. Extracted samples of Buna S give pale violet to colourless solns., but compounded samples give solns. ranging from light yellow to deep brown. Group VI—Destructive distillation of Butyl rubber yields a white vapour condensing with difficulty to a light yellow mobile oil. A. O. J.

Inorganic

Determination of Antimony in Tin-Base Alloys. G. L. Luke (*Ind. Eng. Chem., Anal. Ed.*, 1944, 16, 448–451)—A direct volumetric bromate method. Heat 1 g of finely-divided alloy in a dry 500-ml conical flask with 10 ml of strong sulphuric acid, first on a hot plate, then over a Tirrill burner until solution is complete and strong fumes are evolved. Cool, add 10 ml of water, a few grains of silicon carbide to prevent bumping, and 50 ml of hydrochloric acid. Warm to 50° C. to dissolve the salts, add 25 ml of 6% sulphur dioxide soln. and boil down to a volume of 60 ml; remove from the heat, add 350 ml of boiling water and pass a fairly rapid air current for 5 min. Titrate as usual with 0.1 N bromate, using methyl orange as indicator. The small amount of iron in the alloy does not interfere, since the reducing action of sulphur dioxide is slow in the strongly acid soln. The interference of

Group	Rubber type	Density behaviour of condensate			
		Colour of soln.		I	II
		I	II		
Blank	—	yellow	blue	—	—
I	Buna N	green	blue	sinks	sinks
II	Neoprene GN Chloroprene nitrile polymers Polyvinyl chloride	red	yellow	sinks	sinks
III		Polyvinyl acetate	yellow	yellow	sinks
IV	Buna S	yellow	blue	sinks	sinks
V	Natural rubber	yellow	blue	sinks	floats
VI	Butyl	yellow	blue	floats	floats

Apply the following confirmatory tests. Group I—To confirm Buna N, combine the contents of the 2 tubes, add 1 drop of 5% sodium hydroxide soln. and 1 ml of 5% ferrous sulphate soln. containing 1% of conc. hydrochloric acid, heat gently and acidify with hydrochloric acid. A fine ppt. of Prussian blue, appearing green in presence of the indicators, shows the presence of nitrile nitrogen in the sample. Group II—The same test will distinguish chloroprene nitrile polymers from Neoprene GN. Shake 0.2 g of the sample with 2 ml of iodine soln. (0.2 g per litre in carbon tetrachloride). If the violet colour fades noticeably in 2–3 min. the sample is Neoprene GN; if it persists the compound is based on polyvinyl chloride. Group III—Warm 0.2 g gently with 2 ml of 55% w/w sulphuric acid; if decomposition occurs the compound is based on polyvinyl acetate. Groups IV and V—To detect possible interference by asphaltic extenders in the test that distinguishes natural rubber from Buna S, shake 0.2 g with 2–3 ml of chloroform. If the chloroform darkens, the test should be repeated on a sample which has been extracted for 4 hr. with chloroform and dried in a vacuum oven for 1 hr. at 70° C. In Weber's test to distinguish natural rubber from Buna S, heat 0.1 g with a drop of bromine without charring the mixture. Remove the

copper is more pronounced, owing to catalytic oxidation of the antimonious salt during solution of the alloy. In the above method the antimonious chloride is reduced by the sulphur dioxide and the arsenic is expelled with the excess of reducing agent in the subsequent boiling. Serviceable results were obtained with Bureau of Standards alloys containing Sn 7, Cu 3, As 0.05, and Fe 0.03%. W. R. S.

Rapid Electrolytic Determination of Zinc in Magnesium Alloys. S. Weinberg and T. F. Boyd (*Ind. Eng. Chem., Anal. Ed.*, 1944, 16, 460–461)—Dissolve 0.5 g in 25 ml of sulphuric acid (1 : 14) in a tall 200-ml beaker. Add 2 ml of 25% tartaric acid soln. and 17–20 g of ammonium chloride and dilute to 100 ml. Add rosolic acid indicator and a faint excess of ammonia; stir and add 4 ml of ammonia (0.90). Electrolyse for 20 min. by gentle air agitation (2 amp.), turning on the electric current before immersing the copper- or nickel-plated platinum cathode. (Nickel cathodes are more convenient.) Quickly replace the beaker with one containing water, repeat this operation, and finally immerse in neutral alcohol. Heat the cathode in an oven at 100° C., removing it as soon as it is dry; cool and weigh. Hydrogen sulphide treatment must be used to eliminate lead, tin,

cadmium, copper or silver, if appreciable. Copper remains undissolved and need not be filtered off in routine work. A determination can be completed within 30 min. W. R. S.

Photometric Determination of Beryllium in Presence of Aluminium and in Aluminium Alloys. W. Stross and G. H. Osborn (*J. Soc. Chem. Ind.*, 1944, 63, 249-251)—The method depends on the development of a brown colour by *p*-nitrobenzene-azo-orscinol with beryllium in alkaline soln., which is determined photometrically with a Spekker absorptiometer or a Pulfrich photometer. The range of alkalinity is rather narrow, requiring careful control, and allowance must be made for the colour of the dye itself. The useful range, under the conditions used, was 0.01 to 0.08 mg of beryllium in 25 ml. Aluminium up to ca. 240 mg in 25 ml has practically no effect, provided that an excess of 1 mol. of sodium hydroxide per mol. of aluminium present is present in addition to that required with beryllium only. The only element having a seriously interfering effect is copper, which must be completely separated. Zinc interferes to only a slight extent (3.3 mg gave the photometric equiv. of 0.04 mg of beryllium), and can be readily removed as sulphide. *Beryllium in Aluminium Alloy*—For a beryllium content of 4% to 0.1%, take a sample weight of 100-200 mg, and for less than 0.1% take 600 mg. Add to the sample, contained in a 25-ml centrifuge tube, a definite volume of 5 N sodium hydroxide (0.74 ml for each 100 mg of sample plus 2 ml in addition), and when solution is as complete as possible, heat, if necessary, dilute the liquid to about 15 ml and transfer it to a 50-ml measuring flask after centrifuging to separate any residue (R). Take an aliquot, e.g., that representing 1 mg of sample for an alloy with 3-8% of beryllium, or 120-240 mg for the lowest beryllium content (0.02-0.01%). Add sufficient 2 N sodium hydroxide to produce, together with the sodium hydroxide content of the aluminium soln. and of the dye soln., a total equiv. to 3 ml of 2 N (only the 2 ml of excess of 5 N sodium hydroxide are counted here as the sodium hydroxide content of the aluminium soln.); then add 5 ml of 0.64 M boric acid soln., dilute to 19 ml and mix without delay to re-dissolve any pptd. hydroxide. Add 6 ml of dye soln. (0.025 g in 100 ml of 0.1 N sodium hydroxide), mix, and determine the photometric extinction. (The dye soln. is prepared by mechanically stirring the dye and alkali soln. for several hours and filtering.) The amount of beryllium is found by reference to a calibration curve established with solns. of known beryllium content containing 2.7 ml of 2 N sodium hydroxide, 5 ml of 0.64 M boric acid and 6 ml of dye soln. The blank value of the soln. without beryllium is deducted both in the determination and in establishing the calibration curve. Normally, no significant amount of beryllium remains in the alkali-insoluble residue (R) from alloys with less than 0.2% of beryllium, and only traces from richer alloys, e.g., 0.02% was found from a 4.5% beryllium alloy. To determine the beryllium in this residue, dissolve it in the tube in 1 ml of 8 N sulphuric acid and 1 ml of 20 vol. hydrogen peroxide. Decompose the excess of peroxide by heating and add 20 mg of fine trimmings of pure aluminium to ppt. the copper. Cool, add 7 ml of 5 N sodium hydroxide soln., dilute to 25 ml filter, and take 5 ml for photometric determination as described above. For the determination of beryllium in copper alloys, dissolve the alloy in nitric and sulphuric acids and remove the copper by electrolysis. S. G. C.

Determination of Nitrite with the Griess Reagent. W. V. B. Sundara Ras (*J. Indian Chem. Soc.*, 1944, 21, 51-52)—For the maximum development of colour a long period—over 3 hr.—is required when the reaction proceeds at the ordinary temp. It is now found that the full colour develops on heating the soln. at 100° C. for 5 min. This modification is advantageous in economising in time when Lovibond glasses are used for the colorimetric comparison. S. G. C.

Analysis of Silicates and Dusts from the Witwatersrand Gold Mines. J. J. Frankel (*J. Chem. Met. and Mining Soc., S. Africa*, 1944, 44, 169-179)—The principal object of this investigation was to determine whether any silicates other than sericite were present in appreciable amounts in the conglomerates and, if possible to isolate quantities sufficient for chemical analysis and other determinations; also to determine which minerals were present in the dusts produced underground. Mineral samples from the conglomerate were collected, where possible, by hand picking, but for those in intimate association, fine grinding, followed by gravity separation or centrifuging in heavy liquids, was necessary. The prepared mineral powder was first subjected to spectrographic analysis; this enabled unnecessary chemical determinations of absent or trace elements to be avoided. Optical and other physical tests were then made and, in some instances, X-ray diffraction photographs, establishing the identity of the mineral, were taken. Chemical analysis was carried out on typical samples of sericite, pyrophyllite, chlorite, actinolite, epidote, chloritoid and clay minerals. The results of all the foregoing investigations confirmed that sericite is the dominant silicate in the Banket. For mine dusts, chemical determinations are unreliable where the sample is small and the particle size is less than 2 μ . For such samples, the surest method of distinguishing between quartz and silicate particles is by X-ray diffraction. Comparison with the patterns obtained from synthetic standards containing known proportions of quartz and sericite enabled quantitative results to be obtained. A number of dust samples, including surface crusher dusts, were examined. All but one contained 85-90% of quartz, but one sample, considered to be fairly representative of inhaled dust, contained 25-30% of sericite. It is suggested that useful correlation may be obtained by the application of X-ray diffraction technique to the examination of mineral matter in silicotic lung tissues and residues (*cf.* Nagelschmidt and King, *Biochem. J.*, 1941, 35, 152). B. S. C.

Physical Methods, Apparatus, etc.

Polarographic Reduction of Rhodium Compounds. J. B. Willis (*J. Amer. Chem. Soc.*, 1944, 66, 1067-1069)—A study of the polarographic reduction of a number of rhodium complexes indicates that a pyridine-potassium chloride medium is probably the most suitable for the analytical determination of rhodium. A 3.80×10^{-4} M soln. of rhodium trichloride in *M* pyridine/*M* potassium chloride gives a well-defined step at -0.414 volt. B. S. C.

Spectrophotometric Analysis of Fats. B. W. Beadle and H. R. Kraybill (*J. Amer. Chem. Soc.*, 1944, 66, 1232)—The spectrophotometric method of Mitchell, Kraybill and Zscheile (*Ind. Eng. Chem., Anal. Ed.*, 1943, 15, 1; ANALYST,

1942, 67, 310) has been extended to include animal fats containing small amounts of arachidonic acid. In order to provide a reference standard, methyl arachidonate, approx. 95% pure, was given the same alkali isomerisation treatment as used in the previous investigation, and its absorption characteristics were measured with a Beckman photoelectric spectrophotometer. The "specific absorption coefficients," calculated for 100% purity, at the analytically important wavelengths, are as follows; values obtained for highly purified linolenic and linolic acids, using the same instrument, are also given.

Isomerised fatty acid soap	Specific absorption coefficient at			
	2340A	2680A	3010A	3060A
Arachidonic ..	59.3	53.4	25.8	22.6
Linolenic ..	60.9	53.2	—	—
Linolic ..	86.0	—	—	—

[Abstractor's note—The "specific absorption coefficient," as defined by Mitchell *et al.*, would, using the nomenclature recommended for use in THE ANALYST, be called "specific extinction coefficient," *i.e.*, the extinction coefficient for a solution of concn. 1 g per litre.] B. S. C.

Spectrochemical Analysis of Copper and Cadmium in the Precipitates of Cadmium and Copper Quinaldinates. A. K. Majumdar (*J. Indian Chem. Soc.*, 1944, 21, 24–26)—Using Nitchie's method (*Ind. Eng. Chem., Anal. Ed.*, 1929, 1, 1), quantitative, spectrographic determinations have been made of the amounts of cadmium and copper adsorbed by copper and cadmium quinaldinates respectively. Separations of copper and cadmium, in proportions ranging from *ca.* 20 copper/80 cadmium to 60 copper/40 cadmium w/w, were carried out, as previously described by the author (*ANALYST*, 1943, 68, 242), and the ppts. were converted into anhydrous sulphates before known amounts were arced. Standards were prepared by mixing suitable proportions of cadmium and copper sulphates and quinaldine acid solns., converting into the anhydrous sulphates and arcing exactly as the tests. The results showed that copper quinaldinate pptd. in presence of cadmium adsorbs 0.05 to 0.07% of cadmium; cadmium quinaldinate may adsorb as much as 0.3% of copper (percentages on the weights of metal in the complex). C. F. P.

Spectrographic Determination of Calcium in Presence of Large Quantities of Magnesium.

C. H. Wood (*J. Soc. Chem. Ind.*, 1944, 63, 253–256)—The Scheibe solution method (*Z. angew. Chem.*, 1936, 49, 443) of spectrographic analysis has the advantages that solns. of the pure salts can be used as standards, and any suitable metal salt may be incorporated in the soln. to produce an auxiliary spectrum or to act as a spectroscopic buffer. This technique may be applied to the determination of calcium in magnesite and other magnesium-rich materials. It was found that graphite electrodes were unsuitable, as their calcium content was neither constant nor low enough. Hilger H.S. carbon electrodes showed no trace of calcium when excited under the selected conditions. *Procedure*—Prepare electrodes of the H.S. carbon, 7 to 10 mm long, and polish one end of each to a flat surface with a fine file. Spark the prepared surfaces for 60 sec., using a 15,000 volt A.C. spark, with inductance of 19.7 μ H, capacity of 0.005 μ F and 3 mm spark gap. Dissolve 5 g of the sample to be analysed in the minimum of dil. hydrochloric acid and dilute to 100 ml. Transfer 5 ml of this soln.

to a test-tube, add an equal vol. of alcohol and 2 ml of a soln. containing 3% of nickel. Transfer one drop of this final soln., using a suitable pipette, to the polished end of each of a pair of electrodes. After about 10 min. in air, transfer the electrodes to an oven and dry at 150° C. for 1 hr. Prepare the spectrogram, using a pre-spark period of 90 sec. and exposure of 40 sec. on an Ilford Ordinary plate in a medium quartz spectrograph. With a microphotometer, obtain the ratio of the galvanometer deflexions corresponding to the lines Ca3158.9A and Ni3101.9A. Deduce the calcium content of the sample from a graph prepared from standard solns. of known calcium content with the same technique. The magnesium content of the sample should be within $\pm 5\%$ of that of the standard solns. An important feature is the use of alcohol, which greatly facilitates the uniform and rapid absorption of the soln. by the carbon electrodes. The method gives results accurate to within $\pm 2.5\%$ of the amount present over the range 2% to 8% of calcium oxide; this corresponds to the lime content of commercial magnesia. B. S. C.

Determination of Cresols in Cresylic Acid.

H. W. Thompson and D. H. Whiffen (*Chem. and Ind.*, Sept. 23rd, 1944, 343)—The infra-red absorption spectra of the three isomeric cresols show characteristic differences in the wavelength region 5 to 20 μ . In the region 12 to 14 μ , an intense absorption band is found which may be used for qualitative or quantitative analysis, since its exact position varies with the particular isomer involved and the individual bands are readily separated. Using pure materials, the absolute extinction coefficient for each isomer has been determined from measurements on dilute solns. in a solvent which is transparent throughout the wavelength range concerned. In one measurement, which takes about 10 min., it is possible to estimate each isomer in a mixture, to within a few per cent. of the amount present, using about 0.5 ml of sample. [Abstractor's Note—The authors give no data beyond the above generalisation respecting the various bands.] B. S. C.

Relationship between Cellulose Viscosities Measured by the T.A.P.P.I. Standard and Cupriethylenediamine Methods.

A. J. Corey (*Paper Trade J.*, 1944, 118, May 11, pp. 51–52, *T.A.P.P.I. Sect.*, 167–168)—The standard T.A.P.P.I. method (T 206 m-37) for the determination of the viscosity val. of cellulose at 20° C. (a modification of the original cuprammonium method, *cf.* Clibbens and Geake, *ANALYST*, 1928, 53, 306) is compared with the cupriethylenediamine method (*Id.*, 1942, 67, 178) at 25° C. for 11 samples of bleached sulphite wood pulp covering the viscosity ranges 10.5–85.5 cp. and 16.2–440.0 cp. for the respective methods; the variations between individual tests on the same pulp were 5–15 and *ca.* 2%, respectively. The graphical expression of the results so obtained (for 1% solns.) enables values obtained by the methods to be inter-converted. A standard National Bureau of Standards reference oil (viscosity, 200 cp. at 25° C.) is preferred to glycerin for calibrating the instruments. For the cupriethylenediamine method the samples were disintegrated by stirring in water, formed into a bulky pad on a Buchner funnel, and dried without pressing; the resulting pulp could be torn up by hand, and then dissolved readily in the solvent in 4 min. Pulps of very high or low viscosity should be evaluated in 0.50 and 0.75% concns., and the value for 1% concn. calculated from these. J. G.

Colour Measurement for Control and Research in Papermaking. S. R. H. Edge and H. M. McKenzie (*Proc. Tech. Sect. Paper Makers' Assoc.*, 1943, 24, 201-211)—Comparative trichromatic coeff. and brightness measurements are tabulated, for 6 papers of various shades of white, obtained with the Hilger "Blancometer" and with the Hardy Recording Spectrophotometer. The agreement between the 2 instruments is regarded as good, bearing in mind the fact that a different Standard-A type illuminant was used for each. Comparisons of papers of similar colours are facilitated by comparing the mean tones and colour factors. The former is the average reflectivity of the paper using the red, green and blue filters; on the whole it represents the general reflectivity of the sample better than does the reflectivity in white

light, although the 2 figures are seldom very different. The colour factor is the arithmetic mean of the differences between the reflectivities with each of the 3 filters and the mean tone; for a neutral shade it is zero, and with departures from the neutral which are all of the same shade, it expresses the relative intensity of the colour. Applications of the "Blancometer" to matching the shades of paper and paper colouring matters, to measuring the fastness to light of paper, and to the recording of colour standards for pulp and paper are described. Each instrument requires separate calibration; a very steady supply of mains electricity is necessary to operate it, and the high-tension batteries need frequent checking; the arrangements provided for focusing the needle on the screen are not very convenient. J. G.

Reviews

NUTRITION AND NATIONAL HEALTH. By SIR ROBERT McCARRISON. Pp. 75. London: Faber & Faber, Ltd. 1944. Price 6s.

Here we find reprinted in most attractive and readable form, although "in complete conformity with the authorised economy standards," the three Cantor lectures delivered in 1936 by the former Director of Research on Nutrition in India. His work at the Coonoor laboratories, where Dr. W. T. Aykroyd became his equally distinguished successor, is well known to all students of nutrition, and indeed to an even wider public, both lay and scientific.

Sir Robert McCarrison's impressive demonstrations of the devastating effects that low-grade diets could have on the animal organism were a milestone in the history of the subject. They are summarised in these lectures, with an emphasis that is legitimate but never exceeds the bounds of modesty. The lectures, indeed, constitute a historical document, epitomising as they do the state of knowledge available eight years ago about the relations between diet and health. It is the historical nature of these lectures, moreover, that justifies their reproduction substantially unaltered, although the book contains a number of statements that might not command general acceptance to-day. Some of them need amendment because knowledge has advanced; others are expressions of the author's particular "Weltanschauung" and must be considered to be *obiter dicta* rather than accepted scientific truths. Among these personal opinions I should include the passage (p. 11) reading ". . . there is something in the freshness of food, especially vegetable food—some form of energy perhaps; it may be certain rays of light or electrical property—which gives to it a health-promoting influence." This reads more like a result of mystical revelation than of laboratory experiment. Among the statements requiring modification in the light of contemporary research are those that describe cod-liver oil as a rich source of iodine, herrings as a rich source of vitamin A and vitamin E as occurring in milk and meat; the references to the vitamin B₂ complex naturally would require considerable alteration to bring them up to date.

Both the author's personal views and the statements that no longer hold good, far from being blemishes, serve to emphasise the value of these lectures as a survey of nutritional science at a particular time in its history by one of the most distinguished workers in the field. A. L. BACHARACH

QUANTITATIVE CHEMICAL ANALYSIS. A STUDENT'S HANDBOOK. By Prof. JOSEPH REILLY, M.A., Sc.D., F.R.I.C., F.Inst.P., and EILEEN A. MOYNIHAN, M.Sc. Pp. xiv + 116. Cork University Press. 1944. Price 7s. 6d.

The worth of a laboratory handbook of elementary quantitative analytical chemistry must of necessity, in these days, depend more upon the manner in which the subject is presented than upon its nature; this nature has now been fixed for several generations by custom and the exigencies of the examination syllabus. In this book, intended for second-year students, although the matter is old, the treatment is up-to-date and in keeping with modern analytical practice.

The authors require that, in addition to this, their bench handbook, a student shall have ready access in the laboratory to a selected library of modern standard text-books. A list

of about a dozen recommended reference books includes the excellent texts of Sutton (A. D. Mitchell's ed.) and A. I. Vogel. This will ensure that a student who takes the second-year course solely for examination purposes, or as part of a general education, may fill his requirements by confining himself to the bench book; on the other hand those who wish to make a profession of analytical chemistry will have the satisfaction of being able to lay a firm foundation.

The book is well written, well produced, and practically free from error; the only statement to which exception can be taken is an obscurity in the table on p. 106, whereby it would appear that manganese can be detected by the red lead test in presence of chlorides.

A lack of uniformity in terminology shown by the use of "process" and "method," "estimation" and "determination" as interchangeable pairs of words, often on the same page and sometimes in the same sentence, combined with the invariable use of "c.c." instead of "ml," gives the pages an old-style appearance that may conceivably be prejudicial to that wider appeal of the book hoped for by its sponsors.

An improved technique for separating phosphate ion by the zirconyl chloride method in qualitative analysis is described in an appendix. This will possibly prove of interest to a wider class of chemists than those for whom the book is primarily intended. The improvement consists in means for avoiding the large excess of zirconium that is usually employed. A method is also given for removing the small remaining excess if so desired. Starting with one mg each of Fe, Al, Cr, Mn, Ca, Mg, and 20 mg of phosphate ion, the reviewer obtained a clean separation, followed by sharp confirmatory tests for the ions present, and considers the method worthy of trial by analysts interested in this separation. This qualitative exercise is included in a quantitative handbook because it "provides excellent practice in careful manipulation." Having tried it, one can only offer the opinion that the basic acetate separation would provide a far greater trial of manipulative ability.

F. L. OKELL

A SOURCE BOOK OF AGRICULTURAL CHEMISTRY. By CHARLES A. BROWNE. Pp. 290. Waltham, Mass.: The Chronica Botanica Co., London: Wm. Dawson & Sons, Ltd. 1944. Price \$5.00.

Essentially the book consists of quotations extracted from old works bearing on agricultural chemistry and notes upon them. Generally a short summary of the writings of an old author is given to indicate his work or to show the advancement made in the science of agriculture during his life. The first articles deal with the early Greek nature philosophers living from about 640 B.C. and conclude with writings of the sixteenth century. During the days of Aristotle and Philo of Byzantium knowledge was indeed scanty, and scientific explanations of agricultural processes were non-existent. In the author's view, advancement was not possible until the advent of Paracelsus (about 1500 A.D.), who conceived the idea of "principles," which led to the overthrow of the doctrine of the four old elements. Subsequent chapters relate the truly scientific achievements of some of those old philosophers often classed as mere gold-seeking alchemists. Bacon, Van Helmont, Stahl and Réaumur gave an impetus to agricultural experiment which eventually made warrantable the establishment of schools of research. A surprising amount of work by Black, Priestley and Cavendish had an agricultural application. The final chapter of the book is devoted to Liebig, not only because of his valuable contributions to the science of agriculture, but also on account of the influence he exerted on the outlook of so many of his pupils who were to become chemists of renown. His English pupils included Frankland, Gilbert, Gladstone, Muspratt and Playfair.

To anyone interested in the subject of alchemy the Source Book is important, as it indicates the real value of the work of some of the men often represented as being solely occupied in the attempt to transmute metals. Then anyone having a desire to obtain a picture of the progress of the science of agriculture through the ages will find that the pages of the Source Book supply this.

The illustrations, consisting of the title pages of some well-known early works, are attractive.

F. W. F. ARNAUD

ADVICE TO AUTHORS

THE Council has approved the following notice by the Publication Committee, which is here given in condensed form.

The Society publishes papers concerned with all aspects of analytical chemistry, inorganic and organic, as, for example, food and drugs analysis, analysis of water (including its bacteriological examination), gas analysis, metallurgical assays, biological standardisation and micro-analysis. Papers on these and allied subjects may be submitted for presentation and publication; they may:

- (1) Record the results of original investigations into known methods or improvements therein;
- (2) Record proposals for new methods and the investigations on which the proposals are based;
- (3) Record analytical results obtained by known methods where these results, by virtue of special circumstances, such as their range or the novelty of the materials examined, make a useful addition to analytical information;
- (4) Record the application of new apparatus and new devices in analytical technique and the interpretation of results.

Communications.—Papers (which should be sent to the Editor) will normally be submitted to at least one referee, on whose advice the Publication Committee will be guided as to the acceptance or rejection of any communication. Papers or Notes accepted by the Publication Committee may not be published elsewhere except by permission of the Committee.

Abstracts.—The MS. should be accompanied by a brief abstract of about 100 to 150 words indicating the scope and results of the investigation.

Notes on the writing of papers for THE ANALYST

Manuscript.—Papers and Notes should preferably be typewritten.

The title should be descriptive and should set out clearly the scope of the paper.

Conciseness of expression should be aimed at; clarity is facilitated by the adoption of a logical order of presentation, with the insertion of suitable paragraph or sectional headings.

Generally, the best order of presentation is as indicated below:

- (a) General, including historical, introduction.
- (b) Statement of object of investigation.
- (c) Description of methods used. Working details of methods are usually most concisely and clearly given in the imperative mood, and should be given in this form, at least while economy of paper is pressing, e.g., "Dissolve 1 g in 10 ml of water and add . . .". Well-known procedures must not be described in detail.
- (d) Presentation of results.
- (e) Discussion of results.
- (f) Conclusions.

To be followed by a short summary (100 to 250 words) of the whole paper: items (e) and (f) can often be combined.

Illustrations, diagrams, etc.—The cost of setting up tabular matter is high and columns should therefore be as few as possible. Column headings should be brief or replaced by a number or letter to be used in combination with an explanatory footnote to the table.

Sketches or diagrams should be on white Bristol board, not larger than foolscap size, in Indian ink. Lettering should be in light pencil.

Tables or graphs may be used, but normally not both for the same set of results. Graphs should have the co-ordinate lines clearly drawn in ink.

References.—References should be numbered serially in the text and collected in that order under "REFERENCES" at the end of the paper. They should be given in the following form:

1. Dunn, J. T., and Bloxam, H. C. L., *J. Soc. Chem. Ind.*, 1933, 52, 189t.
2. Allen, A. H., "*Commercial Organic Analysis*," Churchill, London, 1882.

Notes on the Presentation of Papers before Meetings of the Society are appended to the "ADVICE," copies of which may be obtained on application to the Secretary, 7/8, Idol Lane, London, E.C.3.

Not at all new

but we daren't advertise
them before as we could'nt catch up
with the demand

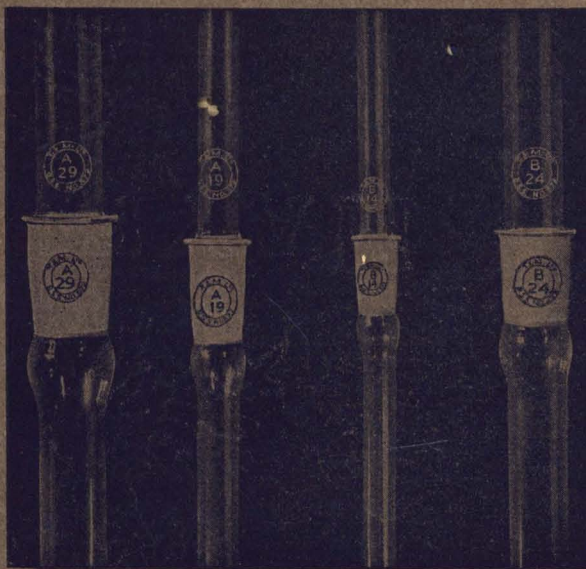

JOINTS TO B.S. SPECIFICATION

Separately, or

As part of a complete apparatus

OUR METAL MASTER JOINTS USED AS STANDARDS ARE N.P.L. CERTIFIED

"NO MORE EXPENSIVE BUT VERY GOOD"

By the way, you may have seen the fuss that the U.S. is making about the ground halfball joints. I feel we ought to tell you that Townson used them in a special Haldane's Apps. he designed 15 years ago.

We shall be delighted to make them again for anyone who really prefers them to B.S. joints, and we agree they have special applications!

R.B.B.



— FOR — "*Service to Science*"

TOWNSON & MERCER LIMITED

390, SYDENHAM ROAD

Telephone: THORnton Heath 3851 (5 lines)

CROYDON

Telegrams: Townson, Croydon

Contents

PROCEEDINGS OF THE SOCIETY OF PUBLIC ANALYSTS AND OTHER ANALYTICAL CHEMISTS		PAGE
Inaugural Meeting of the Microchemical Group, October 4		329
Ordinary Meeting of the Society, October 4		329
Meeting of the North of England Section, April 15		330
New Members		330
Death		330
Some Experiences of Microbiological Assays of Riboflavin, Nicotinic Acid and other Nutrient Factors— D. W. Kent-Jones, Ph.D., B.Sc., F.R.I.C., and M. Melklejohn		330
A Detailed Analysis of the Back Fat of the Pig, with Special Reference to the C_{17-22} Unsaturated Acids— P. B. D. de la Mare, M.Sc., and F. B. Shorland, M.Sc., Ph.D., F.N.Z.I.C.		337
The Determination of Tin in Steels—A. Robertshaw and G. C. Bromfield, Assoc.Met.(Sheff.)		340
Notes—The Fruit Contents of Jams; Estimation of Small Quantities of Diphenylamine; A Micro- Pyknometer		343
Labelling of Food Order		346
Ministry of Food—Statutory Rules and Orders		347
Department of Scientific and Industrial Research—Rapid Surveys of Atmospheric Pollution		347
ABSTRACTS OF PAPERS PUBLISHED IN OTHER JOURNALS		
Food and Drugs—		
RAPID METHOD FOR THE ESTIMATION OF MOISTURE IN DEHYDRATED FISH—R. DAVIES AND W. E. ISAAC		349
DETERMINATION OF GALLIC ACID ADDED TO FATS AND OILS—K. F. MATTEL AND J. J. FILER, JUNR.		349
COMPONENT ACIDS OF SEAL OIL—F. BURKE AND H. JASPERSON		350
DISTINCTIVE TEST FOR SULPHADIAZINE—H. W. RAYBURN		350
ESTIMATION OF THIOURACIL IN URINE—A. B. ANDERSON		350
RAPID ESTIMATION OF PENICILLIN—A. GOTH AND M. T. BUSH		351
Biochemical—		
USE OF DYES FOR THE DETERMINATION OF ACID AND BASIC GROUPS IN PROTEINS—H. FRAENKEL-CONRAT AND M. COOPER		351
COMPOSITION OF CASEIN IN MILK—G. A. RAMSDELL AND E. O. WHITTIER		351
DETERMINATION OF <i>p</i> -AMINO BENZOIC ACID BY ASSAY WITH <i>Clostridium acetobutylicum</i> —J. O. LAMPEN AND W. H. PETERSON		352
COMPONENT FATTY ACIDS OF EARLY AND MATURE HUMAN MILK FAT—A. R. BALDWIN AND H. E. LONGENECKER		352
INTERFERING SUBSTANCES IN THE DETERMINATION OF PHOSPHOGLYCEROL—G. A. LE PAGE		353
IMPROVED THIOCHROME METHOD FOR THE DETERMINATION OF ANEURINE IN URINE—V. A. NAJJAR AND K. C. KETRON		353
EFFECT OF CARAMELISED FRUCTOSE ON THE STABILITY OF <i>l</i> -ASCORBIC ACID—W. E. ISAAC		353
Forensic—		
STAINING OF THE CUTICULAR SCALES OF HAIR—J. DAVIDSON AND W. D. TAYLOR		353
Water—		
MEASUREMENT OF POTENTIAL DIFFERENCE AS A METHOD FOR STUDYING THE ACTION OF WATER ON LEAD PIPES—W. R. G. ATKINS		354
DETERMINATION OF SMALL AMOUNTS OF TANNIN IN WATER—J. HASLAM, J. S. WILSON AND J. E. EDWARDS		354
Agricultural—		
DETERMINATION OF NITRATE, NITRITE AND AMMONIUM NITROGEN IN SOIL AND PLANT EXTRACTS—B. WOLF		354
Organic—		
DETERMINATION OF CARBON-LINKED METHYL GROUPS—W. F. BARTHEL AND F. B. LAForge		355
NEW REAGENT FOR PRIMARY AND SECONDARY AMINES—A. J. BIRCH		355
SEPARATION OF METHYLATED METHYLGLYCOSIDES BY ADSORPTION ON ALUMINA—J. K. N. JONES		356
PURIFICATION AND GRAVIMETRIC DETERMINATION OF 1-DIETHYLAMINO-4-AMINOPENTANE—R. G. JONES		356
IDENTIFICATION OF NATURAL AND SYNTHETIC RUBBERS—H. P. BURCHFIELD		356
Inorganic—		
DETERMINATION OF ANTIMONY IN TIN-BASE ALLOYS—C. L. LUKE		357
RAPID ELECTROLYTIC DETERMINATION OF ZINC IN MAGNESIUM ALLOYS—S. WEINBERG AND T. F. BOYD		357
PHOTOMETRIC DETERMINATION OF BERYLLIUM IN PRESENCE OF ALUMINIUM AND IN ALUMINIUM ALLOY— W. STROSS AND G. H. OSBORN		358
DETERMINATION OF NITRITE WITH THE GRIESS REAGENT—W. V. B. SUNDARA RAO		358
ANALYSIS OF SILICATES AND DUSTS FROM THE WITWATERSRAND GOLD MINES—J. J. FRANKEL		358
Physical Methods, Apparatus, etc.—		
POLAROGRAPHIC REDUCTION OF RHODIUM COMPOUNDS—J. B. WILLIS		358
SPECTROPHOTOMETRIC ANALYSIS OF FATS—B. W. BEADLE AND H. R. KRAYBILL		358
SPECTROCHEMICAL ANALYSIS OF COPPER AND CADMIUM IN THE PRECIPITATES OF CADMIUM AND COPPER QUINALDINATES—A. K. MAJUMDAR		359
SPECTROGRAPHIC DETERMINATION OF CALCIUM IN PRESENCE OF LARGE QUANTITIES OF MAGNESIUM—C. H. WOOD		359
DETERMINATION OF CRESOLS IN CRESYLIC ACID—H. W. THOMPSON AND D. H. WHIFFEN		359
RELATIONSHIP BETWEEN CELLULOSE VISCOSITIES MEASURED BY THE T.A.P.P.I. STANDARD AND CUPRI- ETHYLENEDIAMINE METHODS—A. J. COREY		359
COLOUR MEASUREMENT FOR CONTROL AND RESEARCH IN PAPERMAKING—S. R. H. EDGE AND H. M. MCKENZIE		360
Reviews		360