

THE ANALYST

A Monthly Publication
dealing with all branches
of Analytical Chemistry:
the Journal of the Society
for Analytical Chemistry

Editor: J. B. ATTRILL, M.A., F.R.I.C.

14 BELGRAVE SQUARE, LONDON, S.W.1

Telephone: BELgravia 3258

Published for the Society by

W. HEFFER & SONS LTD., CAMBRIDGE, ENGLAND

Volume 83

Price 10s. 6d.

Subscription Rate, inclusive of Analytical Abstracts, £6 6s. per annum, Post Free

982, Pages 1-64

January 1958



THE FIRST
AND STILL
THE FOREMOST . .

UNIVERSAL
**WATER
BATH**

... WHICH SET NEW
STANDARDS

- ★ 4 STANDARD SIZES
- ★ SPECIAL TOPS FOR INDIVIDUAL DUTIES
- ★ NON-STANDARD SIZES FOR SPECIAL DUTIES WITH OR WITHOUT FORCED CIRCULATION

FULL DETAILS ON REQUEST

LABORATORY THERMAL EQUIPMENT LTD.

GREENFIELD, Nr. OLDHAM, ENGLAND. Tel.: SADDLEWORTH 552

**ANALOID REAGENTS
FOR
METALLURGICAL ANALYSIS**

A range of compressed chemicals specially prepared for the Analoid System of Analysis.

Full particulars and an outline of all methods supplied on request.

**RIDSDALE & CO. LTD.
NEWHAM HALL, MIDDLESBROUGH**

**NEW
BRITISH CHEMICAL STANDARDS**

No. 280 Low Carbon Ferro-Manganese
No. 208/1 High Carbon Ferro-Manganese
No. 181/1 4% Cu Aluminium Alloy to
BS 1490: LM14
No. 182/1 11% Si Aluminium Alloy to
BS 1490: LM20

Full particulars in list No. 390
free on request from

**BUREAU OF ANALYSED SAMPLES LTD
NEWHAM HALL, MIDDLESBROUGH**

IMPORTANT NOTICE TO SUBSCRIBERS

(Other than Members of the Society)

All Subscriptions and renewals to the Journal, including *Analytical Abstracts*, should be sent through a Bookseller or direct to

W. HEFFER & SONS LTD., CAMBRIDGE, ENGLAND

Price 10/6, post free; or to Subscribers in advance post free £6.6s. per annum

N.B.—Members send their subscriptions to the Hon. Treasurer

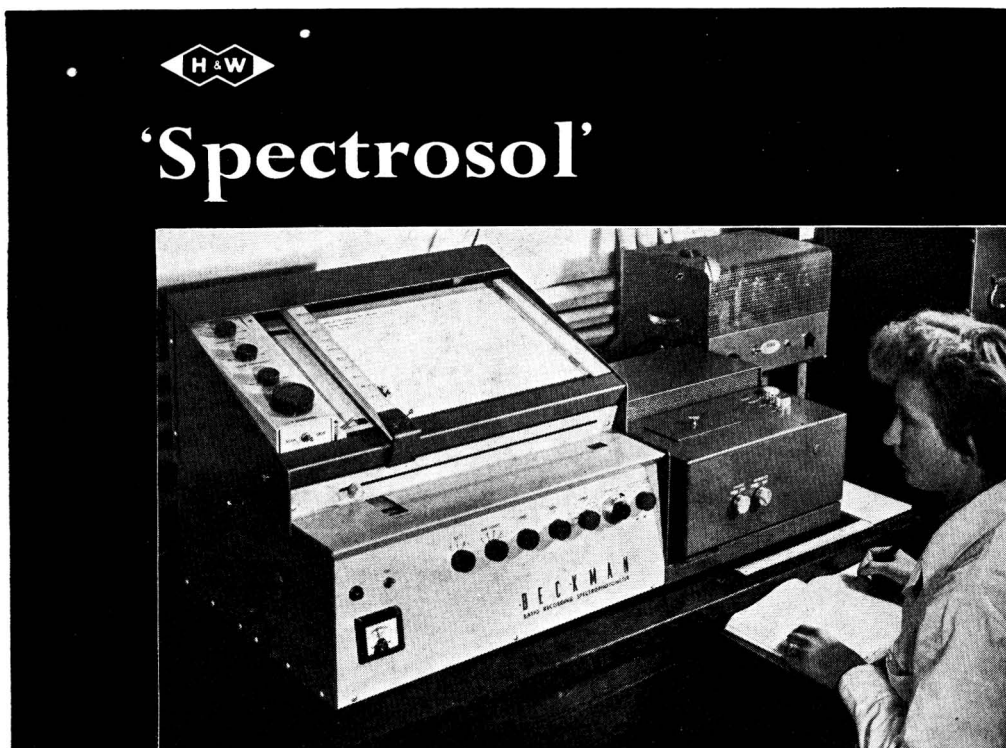

Beckman DK 2 Spectrophotometer in use with 'Spectrosol' Solvents, in the Research and Development laboratories of The Distillers Company Limited at Epsom.

NEW! METHANOL is the latest addition to the range of 'Spectrosol' Solvents for Absorption Spectroscopy.

The first batch of the new solvent has the following characteristics :

TRANSMISSION IN A 1 cm. CELL AT	
2200 A.	2500 A.
53%	93%

Other Solvents in the 'Spectrosol' range have the following typical characteristics :

	TRANSMISSIONS IN A 1 cm. CELL AT	
	2200 A.	2500 A.
Cyclohexane	50%	98%
Ethanol	58%	96%
<i>n</i> -Hexane	78%	98%
<i>iso</i> -Octane	60%	98%

A descriptive leaflet and price list on the complete range of 'Spectrosol' Solvents is available on request.

HOPKIN & WILLIAMS Limited

CHADWELL HEATH · ESSEX · ENGLAND

LONDON · MANCHESTER · GLASGOW and agents all over the world.



**DEHYDRATED CULTURE
MEDIA**

**GRANULES—EASY TO HANDLE,
LESS HYGROSCOPIC**

**TABLETS—FOR SIMPLE PREPARATION OF
SMALL VOLUMES**

Details upon request

Obtainable from Laboratory suppliers or direct from
**OXO LIMITED (Medical Dept) 16, SOUTHWARK BRIDGE ROAD
LONDON, S.E.1
WATERloo 4515**

The BTL wide-range oven

This oven covers the range of 30°C. to 300°C., with excellent heat-up and recovery characteristics. It can be used in three ways—as a **convection oven**, with vent open and without fan, as a **fan-circulated closed oven**, with vent shut and fan on, and as a **forced-draught oven**, with vent open and fan on.

B.S. 2648 readily achieved—conditions easily reproduced for repeat tests—stainless-steel chamber with removable shelves—10" thermo-regulator scale plus built-in thermometer—TV suppressors.

The oven can be supplied with or without fan, which can easily be fitted later if needed.

Write for technical leaflet T.82.

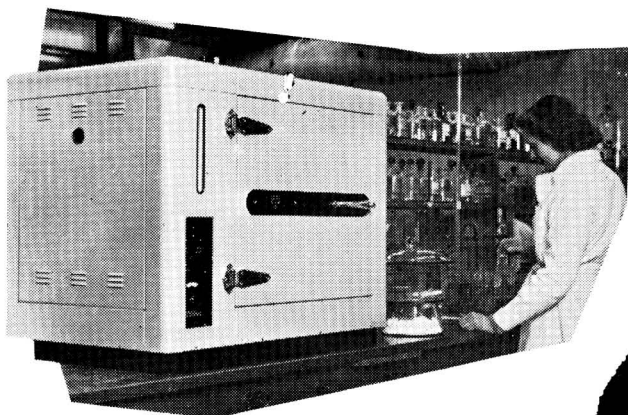

complete laboratory service

BAIRD & TATLOCK (LONDON) LTD., CHADWELL HEATH, ESSEX, ENGLAND.
Branches in London, Manchester and Glasgow. Agents throughout U.K. and all over the world.
TAS/BT.5

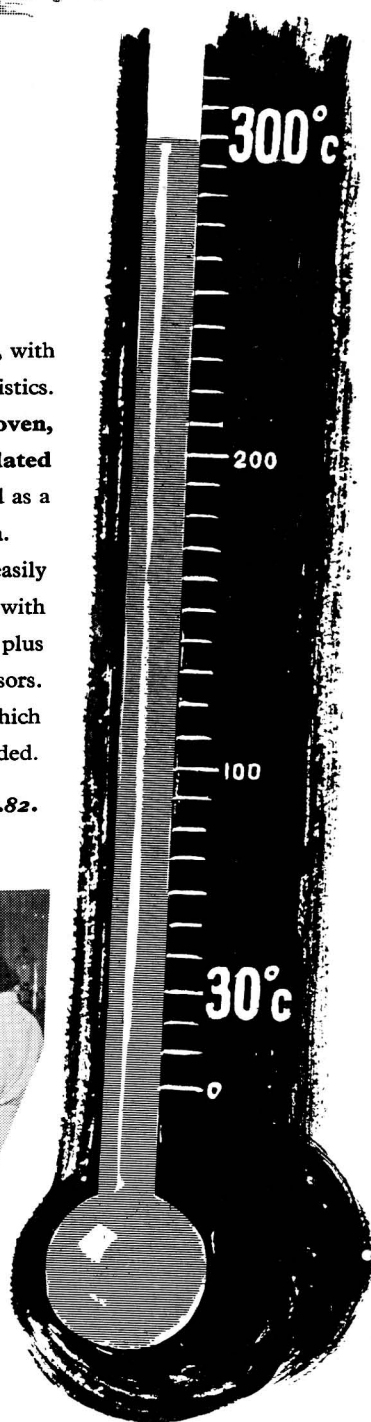

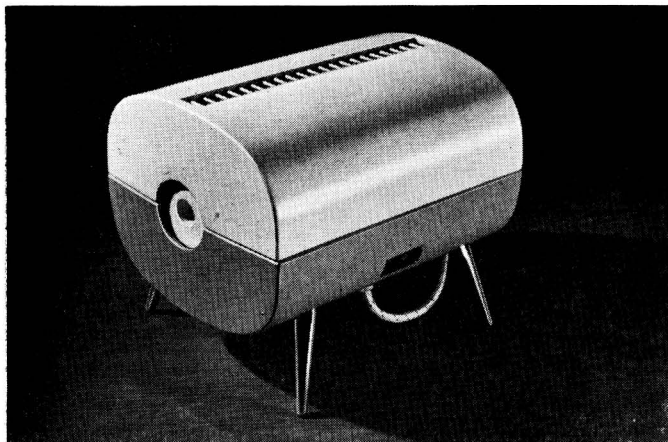

HIGH TEMPERATURE FURNACE DESIGN . . . A NEW APPROACH

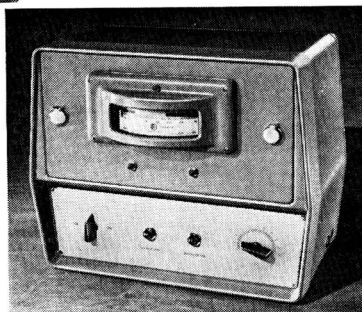

The special control unit supplied for use with the Model 'K' furnace.

The platinum-wound resistance furnace is well-known as the most convenient source of high temperatures for laboratory work and for small-scale processing. It also has the lowest overall operating cost. These advantages are particularly evident in the new JMC Model "K" furnaces. A novel and functional design derived from many years of experience has been developed into a range of furnaces of outstanding reliability and economy, simple and robust in construction and of attractive appearance. The zone of uniform temperature is exceptionally large in relation to the size of the chamber.

Model "K" furnaces are produced in a range of sizes for maximum working temperatures of 1350° or 1500°C. Standard manual or automatic controls are available for single-phase A.C. supply.

Other furnaces with either tubular or rectangular element chambers are manufactured for use at temperatures up to 1750°C.

Full technical details are available on request

SPECIALISED PRODUCTS OF

Johnson  Matthey

JOHNSON, MATTHEY & CO., LIMITED, 73/83 HATTON GARDEN, LONDON, E.C.1
Telephone Holborn 6989

Vittoria Street, Birmingham, 1. Telephone: Central 8004
75/79 Eyre Street, Sheffield, 1. Telephone: 29212

An important
advance in
FLAME
Photometry

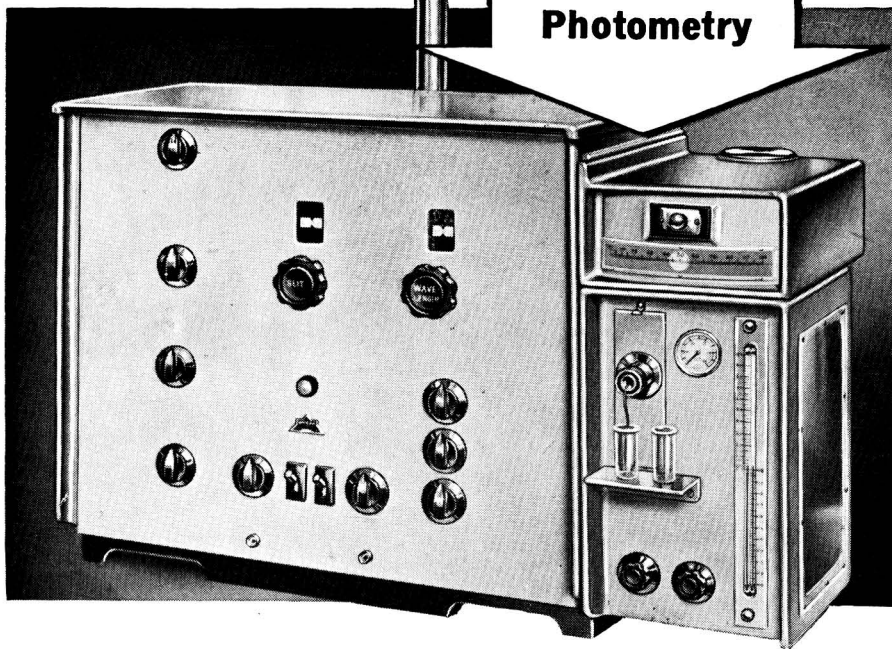

UNICAM

SP.900 FLAME SPECTROPHOTOMETER

FOR EASE • SPEED • SENSITIVITY • RELIABILITY

In the Unicam Flame Spectrophotometer the use of a large fused silica prism for wide dispersion overcomes problems of interference and provides continuous and

accurate wavelength selection from 2,500 Å to 10,020 Å. The high light-gathering power of the optical system gives an improved sensitivity that not only opens new fields of investigation to the research worker but also extends the range and power of flame-photometric applications in the routine laboratory.

The Unicam SP.900 Flame Spectrophotometer is a direct reading instrument, supplied with separate stabilised power supply unit for mains operation. It is quick, reliable and easy to use. Early delivery can be given. Write for full information.

- CONTINUOUS
WAVELENGTH SELECTION
- DIRECT READING
- VARIABLE SLITS
- MAINS OPERATION

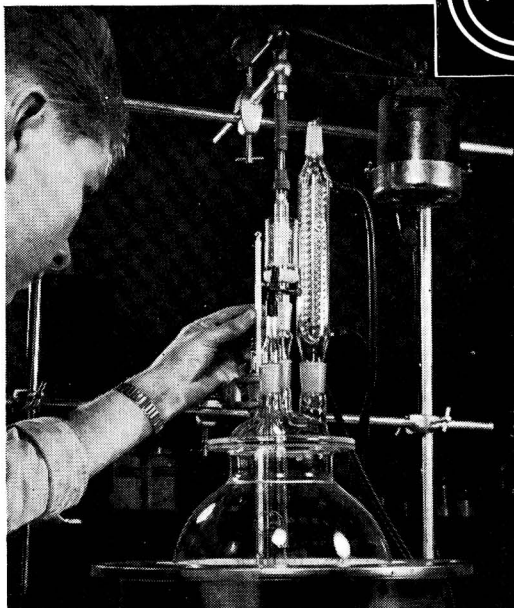

“QUICKFIT” 20 litre Reaction Unit

This relatively large reaction flask makes the unit excellent for the small scale production of fine chemicals. The unit can be quickly and easily converted from reflux to distillation. It requires very little supporting structure.

*Write for Supplement No. 4
giving full details*

TELEPHONE

STONE 481

QUICKFIT & QUARTZ LTD., Dept. O.Y., “Quickfit” Works, Heart of STONE, Staffs.

MODEL



71

Rapid and reliable; the ideal balance for general - purpose laboratory use.

- Capacity 2Kg.
- Sensitivity 0.10g./div.
- Dead-beat scale reading to 10g.
- Stainless-steel pans and robust, vitreous enamel base.

OERTLING

L. OERTLING LTD., CRAY VALLEY ROAD, ST. MARY CRAY, ORPINGTON, KENT.

Telephone: Orpington 25771 (5 lines)

the outstanding purities of

Judactan

analytical reagents

We invite you to compare the actual batch analysis shown here, with the purities guaranteed by the specifications to which you normally work — we are sure the comparison will be helpful to you.

AMMONIUM SULPHATE A.R.

$(\text{NH}_4)_2\text{SO}_4$

Mol. Wt. 132.15

ACTUAL BATCH ANALYSIS

(Not merely maximum impurity values)

Batch No. 11448

Arsenic (As_2O_3)	<0.0001%
Chloride (Cl)	0.00012%
Heavy Metals (Pb)	0.00005%
Iron (Fe)	0.00002%
Nitrate (NO_3)	0.00023%
Non-volatile matter	0.015%
Phosphate (PO_4)	0.00002%
Reaction	pH 5.2
Thiocyanate (SCN)	0.0002%

The above analysis is based on the results, not of our own Control Laboratories alone, but also on the confirmatory Analytical Certificate issued by independent Consultants of international repute

This is the analysis of a Judactan reagent. And, as with every other reagent in the series it is the *actual batch analysis* — it is one of several of which we are especially proud.

THE ANALYST

PROCEEDINGS OF THE SOCIETY FOR ANALYTICAL CHEMISTRY

NEW MEMBERS

ORDINARY MEMBERS

Roger Arnot, B.Sc.(Lond.), F.R.I.C.; Eustace George Coverley Clarke, M.A.(Oxon.), Ph.D. (Reading); Peter Barry Cook, B.Sc. (Lond.), A.R.I.C.; John Aurie Dean, M.S., Ph.D. (Michigan); Peter Albert Charles Jenkins, F.I.M.L.T.; Rhys Haydn Jenkins; Harry McKenzie, A.M.C.T., F.R.I.C.; Margaret Alison McKinnon, B.A.; Robert George Munson, M.Sc. (Bristol); Ronald Samuel Nicolson, A.R.I.C.; James Sanders, A.I.M.

JUNIOR MEMBER

Maduwage Gnanaratna de Silva.

DEATHS

We record with regret the deaths of

Stanley Gordon Kendrick
Frederick Pugh.

NORTH OF ENGLAND SECTION

AN Ordinary Meeting of the Section was held at 7 p.m. on Wednesday, November 13th, 1957, at the College of Further Education, Widnes. The Chair was taken by the Chairman of the Section, Mr. A. N. Leather, B.Sc., F.R.I.C.

The following papers were presented and discussed: "Ion-exchange Chromatography Applied to Closely-related Organic Compounds" and "Trace-element Determinations with the Aid of Ion-exchange Membranes," by D. Logie, B.Sc.

The meeting was preceded at 2.15 p.m., by a visit to the Research Department Laboratories of Imperial Chemical Industries Ltd. (General Chemicals Division).

AN Ordinary Meeting of the Section was held at 2.15 p.m. on Saturday, December 7th, 1957, at the City Laboratories, Mount Pleasant, Liverpool. The Chair was taken by the Chairman of the Section, Mr. A. N. Leather, B.Sc., F.R.I.C.

The following paper was presented and discussed: "Present Trends in the Analysis of Feeding Stuffs," by H. Pritchard, M.Sc., F.R.I.C.

SCOTTISH SECTION

A JOINT Meeting of the Scottish Section and the Department of Chemistry of the University of Edinburgh was held at 4.30 p.m. on Wednesday, November 20th, 1957, at the Department of Chemistry, West Mains Road, Edinburgh, 9. The Chair was taken by Professor E. L. Hirst, C.B.E., LL.D., F.R.S., Department of Chemistry, University of Edinburgh.

The following paper was presented and discussed: "A New Line in the Development of Metal Indicators," by Dr. Rudolf Přebil.

WESTERN SECTION

A JOINT Meeting of the Western Section and the Association of Public Analysts was held at 2 p.m. on Saturday, November 23rd, 1957, at the College of Technology, Ashley Down Road, Bristol. Mr. P. J. C. Haywood, B.Sc., F.R.I.C., Chairman of the Western Section, welcomed the numerous visitors, after which he invited Mr. F. C. Bullock, B.Sc., F.R.I.C., President of the Association of Public Analysts, to take the Chair.

The following papers were presented and discussed: "Instrumentation in Radioactive Analysis," by E. Minshall, M.Sc., F.R.I.C.; "The Effects of Radiation on Living Cells," by H. F. Freundlich, M.A.; "Radioactivity in Sea Foods and Waters," by G. V. James, M.B.E., M.Sc., Ph.D., F.R.I.C., P.A.I.W.E.; "Radioactivity and its Detection in Effluents," by R. H. Burns, B.Sc., F.R.I.C. (see brief summaries below).

MR. MINSHALL briefly described the instrumentation and measurement of radioactivity, together with the necessary precautions to be observed and corrections to be made in order to obtain true values.

MR. FREUNDLICH described the effects of radiation on living cells and discussed the Compton effect and the importance of oxygen and enzyme inactivation by radiation. The speaker covered the death of white cells and the possibility of infection increasing, and also effects on blood vessels and loss of coagulant properties of the blood.

DR. JAMES described the results of examination of imported canned foods, fish, seaweed and so on for radioactivity, as well as samples of drinking water and radioactive spa waters. The problems of preventing uptake of radioactivity by fishing vessels and their gear when in an area where a discharge has been made was also touched upon.

MR. BURNS spoke of the detection of radioactivity in effluents, and the legal aspects of discharge and treatment of wastes, as well as control of discharge by the various Ministries and their Radiochemical Inspectors.

A JOINT Meeting of the Western Section and the Mid-Southern Counties Section of the Royal Institute of Chemistry was held at 7.45 p.m. on Thursday, November 28th, 1957, at the Cathedral Hotel, Salisbury. The Chair was taken by the Chairman of the Western Section, Mr. P. J. C. Haywood, B.Sc., F.R.I.C.

A lecture on "Current Practice in Chemical Pathology" was given by I. MacIntyre, M.B., B.S.

MIDLANDS SECTION

A JOINT Meeting of the Midlands Section and the Birmingham and Midlands Section of the Royal Institute of Chemistry was held at 7 p.m. on Wednesday, November 13th, 1957, in the Main Chemistry Theatre, The University, Edgbaston, Birmingham, 15. The Chair was taken by the Chairman of the Midlands Section, Dr. R. Belcher, F.R.I.C., F.Inst.F.

The following paper was presented and discussed: "A New Line in the Development of Metal Indicators," by Dr. Rudolf Přibil.

AN Ordinary Meeting of the Section was held at 7 p.m. on Thursday, December 5th, 1957, in the Gas Showrooms, Nottingham. The Chair was taken by Mr. C. A. Johnson, B.Pharm., B.Sc., F.P.S., A.R.I.C.

A discussion on "Non-aqueous Titrations" was opened by E. H. Tinley.

AN Ordinary Meeting of the Section was held at 6.30 p.m. on Wednesday, December 11th, 1957, in the Mason Theatre, The University, Edmund Street, Birmingham, 3. The Chair was taken by the Chairman of the Section, Dr. R. Belcher, F.R.I.C., F.Inst.F.

A discussion on "The Analytical Chemistry of Copper and its Alloys" was opened by H. J. G. Challis, F.R.I.C., A.I.M.

PHYSICAL METHODS GROUP

THE thirteenth Annual General Meeting of the Group was held at 6.30 p.m. on Tuesday, November 26th, 1957, in the meeting room of the Chemical Society, Burlington House, London, W.1. The Chair was taken by the Chairman of the Group, Dr. J. E. Page, F.R.I.C. The following appointments were made for the ensuing year:—*Chairman*—Mr. R. A. C. Isbell. *Vice-Chairman*—Mr. G. W. C. Milner. *Hon. Secretary and Treasurer*—Mr. L. Brealey, Boots Pure Drug Co. Ltd., Standards Department, Station Street, Nottingham. *Members of Committee*—Dr. Bella B. Bauminger, Messrs. H. J. Cluley, W. Cule Davies, A. L. Glenn, A. G. Jones and T. L. Parkinson. Dr. D. C. Garratt and Mr. C. A. Bassett were re-appointed as Hon. Auditors.

The Annual General Meeting was followed at 6.45 p.m. by the 60th Ordinary Meeting of the Group. Mr. R. A. C. Isbell, A.Inst.P., was in the Chair and a lecture on "Infrared Spectroscopy and the Analyst" was given by the retiring Chairman, J. E. Page, D.Sc., Ph.D., F.R.I.C.

Recent Advances in the Preparation and Uses of Ion-exchange Resins

A Review*

By D. K. HALE

(*High Polymers Group, Chemical Research Laboratory, Teddington, Middlesex*)

SUMMARY OF CONTENTS

Introduction
New ion-exchange materials
Chelating resins
Ion-exchange papers
Ion-exchange membranes
Other new materials
New techniques
Gradient elution
Ion-exclusion and partition chromatography
Other new techniques
Future developments

MANY of the most important recent developments in pure and applied chemistry have taken place largely as a result of improvements in separation techniques. In many of these developments, ion-exchange resins and ion-exchange chromatography have played an important part. Some of the more spectacular successes of ion-exchange techniques have been in the separation of the rare earths¹ and in the isolation of promethium² and the transuranium elements,^{3,4,5,6,7} but, in many laboratories, ion-exchange resins are now also used as established analytical tools. They are widely employed not only in simple analytical problems, such as the determination of salt concentrations, but also for the separation of complex mixtures of closely related substances, such as amino acids⁸ and nucleic acid degradation products.⁹ Since the publication of the American work on the separation of fission products, a wide variety of procedures for the separation of inorganic ions by ion-exchange chromatography have been described, and Boyd¹⁰ has said—

“That it is now possible to separate every element in the periodic table which forms an ion in solution from every other such element by proper employment of the techniques of ion-exchange chromatography appears to be a reasonably safe conclusion.”

The principles and methods employed in the established ion-exchange techniques are well described in the book by Samuelson,¹¹ whose pioneer work on the application of ion-exchange resins in analytical chemistry has been largely responsible for the widespread adoption of ion-exchange methods in the laboratory. The methods used for the separation of complex mixtures by ion-exchange chromatography are also described in two recent books on ion-exchange technology¹² and on the use of ion-exchangers in organic chemistry and biochemistry.¹³ Since the field of application of ion-exchange resins is now so wide, in this review it will be possible to describe only some of the more recent advances that are likely to be of interest to the analytical chemist. The more important developments may be classified somewhat arbitrarily into two groups: (a) new ion-exchange materials and (b) new techniques.

NEW ION-EXCHANGE MATERIALS

CHELATING RESINS—

Although different ions have different affinities for ion-exchange resins of the conventional type containing either acidic groups, such as the $-\text{SO}_3\text{H}$ group, or basic groups, such as the quaternary ammonium group, these differences in affinity are frequently too small to form the basis of a readily effected separation, especially when the ions to be separated are very similar in their properties. Most of the separations carried out by ion-exchange chromatography have therefore been based on differences in the degree of dissociation of the substances being separated or on the stability of their complexes, rather than on differences in the

* Based on a lecture delivered at the meeting of the Midlands Section on Thursday, October 25th, 1956.

affinities of the ions for the resin. For example, in the separation of the rare earths, use is made of the differences in the stability of their complexes with citric acid or ethylenediaminetetra-acetic acid. This lack of highly selective properties has, however, meant that the conventional ion-exchange resins have been used extensively in chromatographic procedures, since, by appropriate selection of eluting agents, they can be used for a wide variety of applications. In the past few years there has, however, been increasing interest in the development of resins containing special functional groups that would be expected to result in highly selective behaviour. Interest has very largely centred on the preparation of resins containing chelating groups that might be expected to show highly selective absorption behaviour towards metal cations. These resins have been described as chelating resins or chelating ion-exchange resins. Their preparation and properties have been described in recent reviews^{14,15} and only a short account of them will be given in this review.

The first attempt to prepare a resin showing highly selective behaviour was made in 1940 by Skogseid,¹⁶ who synthesised a polystyrene resin containing functional groups similar in structure to dipicrylamine. Dipicrylamine forms a sparingly soluble potassium salt, which may be a chelate compound, and Skogseid was able to show that the resin containing similar groups had a higher affinity for potassium than had other ion-exchange resins. This resin has recently been studied in more detail, and Skogseid's results have been confirmed.¹⁷ Most of the chelating resins so far described have been obtained by condensing compounds such as *m*-phenylenediglycine¹⁸ with formaldehyde, or anthranilic acid with resorcinol and formaldehyde.^{18,19,20} Chelating resins with polymer networks similar to those in the more recently developed ion-exchange resins should, however, have greater physical and chemical stability. Cornaz and Deuel²¹ have described a chelating resin containing hydroxamic groups that was based on a commercial carboxylic resin; this absorbed ferric ions selectively. Chelating resins prepared from cross-linked polystyrene and containing 8-hydroxyquinoline²² and amino acid groups¹⁴ have also been prepared. The former resin strongly absorbed copper, nickel and cobalt ions in the pH range 2 to 3, whereas resins of the latter type showed very similar behaviour, the order of affinity for bivalent ions of the first transition series corresponding to the Irving - Williams order of stability observed with soluble complexes.

Until recently, little has been published on the characterisation or possible applications of chelating resins, but it appears likely that they may eventually prove useful for the determination of trace metals and in some inorganic separations. Blasius and Olbrich²³ have described the application of a chelating resin prepared from *m*-phenylenediaminetetra-acetic acid to the separation of alkali-metal ions from copper or nickel, to the separation of alkaline earths from copper and to the separation of cobalt and nickel. In the first example, the alkali metal was eluted from the chelating resin with 0.01 *N* hydrochloric acid, the effluent was passed through a column of a strongly basic resin in the hydroxyl form, and the solution of the alkali-metal hydroxide was titrated with 0.1 *N* hydrochloric acid. The copper or nickel was then eluted from the chelating resin with 2 *N* hydrochloric acid and determined by direct titration.

A major disadvantage of the chelating resins containing weakly acidic groups is the slow rate of exchange, so that long columns or very slow flow-rates have to be employed. Resins containing stronger acidic groups may prove superior in this respect, and Kennedy and Davies²⁴ have described the application of phosphonic acid chelating resins to the separation of uranium from heavy metals. It may be noted that some of the commercially available ion-exchange resins show highly selective behaviour in special instances. For example, some of the phenolic resins containing methylenesulphonic acid groups have an exceptionally high affinity for caesium²⁵ and have been used for the determination of caesium in sea water²⁶ and for the separation of milligram amounts of caesium from large amounts of other alkali-metal salts.²⁷

ION-EXCHANGE PAPERS—

In conventional ion-exchange chromatography a column of resin is employed, and the effluent is usually collected in fractions, which are subsequently analysed. To obtain a satisfactory separation, local equilibrium should be closely approached at all points in the column; if the rates of exchange are slow, this means that an extremely finely divided resin and a very slow flow-rate have to be employed. In qualitative analysis a procedure similar to that in paper partition chromatography should possess advantages. Ion-exchange properties can be conferred on filter-paper by the introduction of acidic or basic groups into the cellulose

molecule, and the application of ion-exchange papers of this type containing carboxylic, sulphonic and quaternary ammonium groups has been described.^{28,29} More recently, Kember and Wells³⁰ have described chromatographic separations on papers prepared from aminated and phosphorylated cellulose. Cation- and anion-exchange papers can also be made by incorporating finely divided ion-exchange resins in the cellulose pulp used for the preparation of the paper³¹; the chromatographic behaviour of ions on the resultant ion-exchange paper has been found to be similar to that observed in column experiments with the same resin. A similar technique has been described by Lederer,³² who incorporated particles of ion-exchange resin in filter-paper by passing a strip of the paper through a suspension of colloidal aggregates of Dowex 50 or an anion-exchange resin of a fine particle size. Paper prepared in this way has been used for the separation of selenium and tellurium.³³ A spot of a solution containing a mixture of sodium selenite and sodium tellurite was applied to a strip of paper impregnated with Dowex 50. The paper was then eluted with acid and sprayed with a solution of stannous chloride in 5 *N* hydrochloric acid. It was found that the tellurium, unlike the selenium, exhibited a marked cationic character in acid solution, and good separations of the two elements were achieved. The use of filter-paper containing finely divided ion-exchange resins for the quantitative determination of cations and anions has also been described.^{34,35}

ION-EXCHANGE MEMBRANES—

There is at present considerable interest in the development of ion-exchange materials in sheet form for use as membranes in electro-dialytic and electrochemical processes. Cation-exchange membranes are permeable to cations, but are relatively impermeable to anions; similarly, anion-exchange membranes allow the passage of anions, but are relatively impermeable to cations. Ion-exchange membranes of both types are commercially available; the cation-exchange membranes, *e.g.*, Permaplex C-10 (The Permutit Co. Ltd.), contain sulphonic acid groups and the anion-exchange membranes, *e.g.*, Permaplex A-10, contain strongly basic quaternary ammonium groups. Both types of membranes have a low electrical resistance and show highly selective behaviour towards cations and anions, respectively. If these ion-exchange membranes are used instead of the comparatively non-selective membranes previously employed in electro-dialysis, the process becomes very much more efficient and salts can readily be removed from solutions that are too concentrated to be treated by the usual ion-exchange procedures.

Although the commercially available ion-exchange membranes have been developed primarily for large-scale applications, they are also suitable for laboratory use. In the analysis of mixtures of amino acids and other substances by paper chromatography, it is often necessary to remove inorganic salts before the mixture is analysed. The usual methods may result in the loss of 10 or 20 per cent. of many of the amino acids and, moreover, arginine may be largely converted to ornithine. Small laboratory electro-dialysers have been described^{36,37} in which an electrolytic cell fitted with platinum or carbon electrodes is divided into three compartments by a cation- and an anion-exchange membrane. The solution to be desalted is placed in the central compartment and tap water or dilute electrolyte solution in the electrode compartments. When a potential is applied to the cell, cations and anions in the central compartment pass into the electrode compartments through the ion-exchange membranes, which prevent the entry of anions and cations moving in the opposite directions. A similar method has been employed for the de-ionisation of aqueous solutions of plant extracts.³⁸ The use of ion-exchange membranes in the electro-dialysis cell permitted de-ionisation of the solutions without loss of sugars. An electrolytic cell divided into two compartments by a cation-exchange membrane has been used in the determination of boron in a sodium hydroxide solution.³⁹ The anode compartment was filled with the hydroxide solution and the cathode compartment with 0.5 *N* sodium hydroxide. On passage of an electric current, sodium ions passed through the membrane into the catholyte and the boron remained in the anolyte. The concentration of sodium hydroxide in the anolyte was reduced to 0.007 *N*, and the boron was determined colorimetrically after removal of interfering elements such as aluminium, chromium and manganese on a column of a cation-exchange resin. The method could be used for the determination of boron in sodium metal and has proved valuable in the preparation of boron-free sodium hydroxide.

Although membranes based on ion-exchange resins are a relatively new development, the properties of biological membranes that show ion-selective behaviour had been the subject

of extensive investigation many years before the discovery of ion-exchange resins, and highly selective membranes based on collodion had been prepared. The more recent membranes of this type that have been developed by Sollner⁴⁰ have proved to be suitable for the determination of ion activities in solutions of electrolytes. The most effective cation-exchange membranes of this type were prepared by incorporating sulphonated polystyrene in a collodion membrane. Highly selective anion-exchange membranes were prepared by treating collodion membranes with solutions of protamine sulphate. Membranes prepared in this way may be used for the determination of the activities of many ions for which specific reversible electrodes are not available, *e.g.*, fluoride, nitrate and acetate, or when it is difficult to set up a suitable electrode, *e.g.*, with alkali-metal and alkaline-earth cations. These membranes can therefore be used for the determination of ion activities in single electrolyte solutions in much the same way that a glass electrode is used for the determination of hydrogen-ion activities. The membranes developed by Sollner appear to be particularly suitable for this purpose and have been used successfully in studies on the binding of alkali-metal and alkaline-earth cations in protein solutions^{41,42} and in potentiometric titrations.⁴³ Membranes prepared in the laboratory by moulding a finely divided ion-exchange resin with an inert binder such as polystyrene or polyethylene have also been used successfully for the determination of ionic activities and in potentiometric titrations.^{44,45,46} When commercial ion-exchange resin membranes are being applied in the determination of ionic activities, the use of a strip or ribbon of the ion-exchange material has been found to be advantageous.⁴⁷

OTHER NEW MATERIALS—

In the separation of large molecules, such as proteins, by ion-exchange chromatography, the exchange process is confined to the surface of the resin particles. In most of the earlier work on protein separations the weakly acidic cation-exchange resin Amberlite IRC-50 was employed. Recently, special ion-exchange materials for protein separations have been developed. These include chemically modified celluloses^{48,49,50,51} and ion-exchange materials prepared by coating the surface of kieselguhr with sulphonated cross-linked polystyrene.^{52,53} The recent introduction of a new type of highly porous polystyrene ion-exchange resin⁵⁴ may lead to further developments in the ion-exchange separation of large molecules. The use of ion-exchange chromatography for the separation of peptides, proteins and nucleic acids has been described in two recent review articles.^{55,56}

NEW TECHNIQUES

The use of ion-exchange resins in the study of complexes has led in turn to the development of a wide variety of procedures for the separation of inorganic ions by ion-exchange chromatography. The methods developed by Kraus, Moore and Nelson⁵⁷ for the separation of metals in the form of their chloro complexes on anion-exchange resins are of very wide application and some remarkable separations have been achieved by this simple yet elegant technique. The general principles involved in the application of these methods in analytical chemistry have been described by Jentzsch,⁵⁸ and a summary in tabular form of the work of Kraus and his colleagues has recently been published.⁵⁹ Many other methods involving the use of selective eluting agents, *e.g.*, phosphoric acid^{60,61} and organic solvents,^{62,63} have been described. And, as such a wide selection of procedures is now available for the separation of inorganic ions, improvements in experimental techniques such as the use of gradient elution appear to be most likely to lead to important developments. In the organic field some interesting separations have been carried out by the processes known as "ion exclusion" and by partition chromatography.⁶⁴

GRADIENT ELUTION—

The technique of gradient elution is being employed to an increasing extent in ion-exchange chromatography. In elution procedures in which it is necessary, for example, to increase the acidity of the eluting agent to remove the more strongly absorbed components a gradient-elution technique can be used, in which the acid concentration of the eluting agent is increased continuously. When this procedure is employed, "tailing" is reduced or eliminated and the discontinuities or duplication of peaks, which may arise on changing an eluting agent, are avoided. In a typical gradient-elution procedure the eluting agents are passed successively into a mixing chamber, which is mounted over a magnetic stirrer. If the mixing chamber initially contains a solution of one concentration and a solution of a higher concentration is

added continuously, the concentration of the eluting agent will at first increase rapidly and then slowly approach that of the added solution. The composition of the eluting agent may be varied in different ways by suitable adjustment of the rates at which the solutions flow into and out of the mixing vessel.⁶⁵ Gradient elution is now employed in the procedure developed by Moore and Stein for the separation of amino acids,⁸ and its application to the separation of the rare-earth elements⁶⁶ and to the separation of ortho-, pyro-, tri-, trimeta- and tetrameta-phosphates⁶⁷ has recently been described. The theory of gradient elution has been discussed by Drake,⁶⁸ Freiling^{69,70} and Piez.⁷¹

ION-EXCLUSION AND PARTITION CHROMATOGRAPHY—

If a strongly acidic cation-exchange resin in the sodium form is allowed to come in contact with a solution containing sodium chloride and a non-electrolyte such as glycerol, the equilibrium concentration of sodium chloride inside the resin particles will be very much less than in the external solution, owing to the Donnan equilibrium effect. The uncharged glycerol molecules will, however, be absorbed by the resin, and in this way a partial separation of sodium chloride and glycerol could be obtained. By using a column of the resin and a chromatographic procedure with water as eluting agent, a complete separation of charged molecules from uncharged molecules can be achieved. The use of this process, which is known as "ion exclusion," for the purification of sugar⁷² and glycerol⁷³ has been described. Although water is used as an eluting agent and acidic or basic regenerants are not required, the solutions to be treated are diluted in the process unless special procedures are adopted and, moreover, slow flow-rates and resin of fine particle size have to be employed. It is, however, likely that ion-exclusion techniques may eventually prove of value in the laboratory for the separation of strong electrolytes from uncharged molecules, especially as uncharged molecules are sometimes strongly absorbed by ion-exchange resins.^{74,75} Since the extent to which it is absorbed depends on the nature of the uncharged molecule, ion-exchange resins can be used for the separation of mixtures of non-electrolytes or weak electrolytes by partition chromatography.⁷⁶ With alcohols the separation is greatly improved by the use of a salt solution as the eluting agent instead of water, and this method has been described as "salting-out chromatography."^{77,78}

OTHER NEW TECHNIQUES—

A number of analytical procedures involving ion-exchange resins have recently been developed in which chemical reactions take place either at the surface of, or within, the resin particles. For example, the use of anion-exchange resins for the adsorption of trace amounts of cations by the formation of insoluble salts has recently been described.⁷⁹ In experiments with a column of Amberlite IRA-400 and solutions containing trace amounts of caesium, strontium and a zirconium-niobium mixture, it was found that a column in the hydroxide form did not retain the caesium and strontium, but collected quantitatively the zirconium-niobium mixture; a column in the oxalate form retained most of the strontium, but not caesium; and a column in the carbonate form retained strontium. This method is reported to be more efficient and more selective than the conventional co-precipitation techniques and has been found to be suitable for the rapid separation and determination of radiostrontium and radiocaesium in fission-product mixtures.^{80,81} A similar procedure has been described for the separation of barium-140 from lanthanum-140.⁸² This technique has also been used in a method for the rapid determination of the major anions in fresh water,⁸³ in which a column of a strongly acidic cation-exchange resin in the silver form was used for the selective retention of chloride ions, a process similar in principle to the technique developed during the war for the removal of salt from sea water with silver zeolites. It has also been found that the sensitivity of precipitate-forming spot-tests can be improved by the use of ion-exchange resins.⁸⁴ As an example, a strongly basic resin in the chloride form was employed in the detection of silver.

The use of ion-exchange resins for increasing the sensitivity and selectivity of a number of other spot-tests has also been reported recently.^{85,86} In a typical example, an anion-exchange resin that has been treated with haematoxylin solution is used for the detection of germanium^{IV}. An anion-exchange resin with a low degree of cross-linking is added to a haematoxylin solution; after a few hours the resin particles become bright yellow. A few of the dried resin particles are then added to a drop of the sample solution. If germanium is present, the resin particles become brown to red-violet in colour. The limit of identification

is said to be remarkably low ($0.005 \mu\text{g}$) and the limiting concentration 1 in 6×10^6 . Interfering ions such as Fe^{3+} and Bi^{3+} can be removed by preliminary treatment of the sample solution with a cation-exchange resin.

FUTURE DEVELOPMENTS

Many of the special ion-exchange resins that have been developed recently are only of ephemeral interest, but some may become of importance to the analytical chemist. Further research on the preparation and properties of ion-exchange membranes may lead to new techniques for the separation and determination of ions by electrochemical methods.

In recent years, rapid progress has been made in the use of ion-exchange resins in analytical procedures and it may be expected that they will find even wider application in the future, particularly in problems involving the separation of complex mixtures.

This paper is published by permission of the Director of the Chemical Research Laboratory.

REFERENCES

1. Spedding, F. H., *Disc. Faraday Soc.*, 1949, No. 7, 214.
2. Marinsky, J. A., Glendenin, L. E., and Coryell, C. D., *J. Amer. Chem. Soc.*, 1947, **69**, 2781.
3. Seaborg, G. T., and Katz, J. J., *Editors*, "The Actinide Elements," McGraw-Hill Book Co. Inc., New York, 1954.
4. Seaborg, G. T., Katz, J. J., and Manning, W. M., *Editors*, "The Transuranium Elements," McGraw-Hill Book Co. Inc., New York, 1949.
5. Ghiorso, A., Harvey, B. G., Choppin, G. R., Thompson, S. G., and Seaborg, G. T., *Phys. Rev.*, 1955, **98**, 1518.
6. Hyde, E. K., "Peaceful Uses of Atomic Energy," Proceedings of the International Conference in Geneva, August, 1955, United Nations, 1956, Volume VII, p. 281.
7. Coleman, J. S., Penneman, R. A., Keenan, T. K., La Mar, L. E., Armstrong, D. E., and Asprey, L. B., *J. Inorg. Nuclear Chem.*, 1956, **3**, 327.
8. Moore, S., and Stein, W. H., *J. Biol. Chem.*, 1954, **211**, 893.
9. Cohn, W. E., *Ann. N.Y. Acad. Sci.*, 1953, **57**, 204.
10. Boyd, G. E., *Ann. Rev. Phys. Chem.*, 1951, **2**, 309.
11. Samuelson, O., "Ion-exchangers in Analytical Chemistry," J. Wiley & Sons Inc., New York, 1953.
12. Nachod, F. C., and Schubert, J., *Editors*, "Ion-Exchange Technology," Academic Press Inc., New York, 1956.
13. Calmon, C., and Kressman, T. R. E., *Editors*, "Ion-Exchangers in Organic and Biochemistry," Interscience Publishers Inc., New York, 1957.
14. Hale, D. K., *Research*, 1956, **9**, 104.
15. Millar, J. R., *Chem. & Ind.*, 1957, 606.
16. Skogseid, A., Ph.D. Thesis, Norges tekniske Høgskole, Trondheim, 1946, "Noen Derivater av Polystyrol," Aas & Wahls, Oslo, 1948.
17. Woermann, D., Bonhoeffer, K. F., and Helfferich, F., *Z. Phys. Chem.*, 1956, **8**, 265.
18. Gregor, H. P., Taifer, M., Citarel, L., and Becker, E. I., *Ind. Eng. Chem.*, 1952, **44**, 2834.
19. von Lillin, H., *Angew. Chem.*, 1954, **66**, 649.
20. Jenckel, E., and von Lillin, H., *Kolloidztschr.*, 1956, **146**, 159.
21. Cornaz, J.-P., and Deuel, H., *Experientia*, 1954, **10**, 137.
22. Parrish, J. R., *Chem. & Ind.*, 1956, 137.
23. Blasius, E., and Olbrich, G., *Z. anal. Chem.*, 1956, **151**, 81.
24. Kennedy, J., and Davies, R. V., *Chem. & Ind.*, 1956, 378.
25. Miller, H. S., and Kline, G. E., *J. Amer. Chem. Soc.*, 1951, **73**, 2741.
26. Smales, A. A., and Salmon, L., *Analyst*, 1955, **80**, 37.
27. Ring, S. A., *Anal. Chem.*, 1956, **28**, 1200.
28. Lautsch, W., Manecke, G., and Broser, W., *Z. Naturforsch.*, 1953, **8b**, 232.
29. Ströle, U., *Z. anal. Chem.*, 1955, **144**, 256.
30. Kember, N. F., and Wells, R. A., *Nature*, 1955, **175**, 512.
31. Hale, D. K., *Chem. & Ind.*, 1955, 1147.
32. Lederer, M., *Anal. Chim. Acta*, 1955, **12**, 142.
33. Lederer, M., and Kertes, S., *Ibid.*, 1956, **15**, 226.
34. Witkowski, H., *Roczn. Chem.*, 1956, **30**, 549.
35. Lewandowski, A., and Ignasiak, J., *Ibid.*, 1956, **30**, 559.
36. Blainey, J. D., and Yardley, H. J., *Nature*, 1956, **177**, 83.
37. Wood, T., *Biochem. J.*, 1956, **62**, 611.
38. Anderson, A. M., and Wylam, C. B., *Chem. & Ind.*, 1956, 191.
39. Logie, D., *Ibid.*, 1957, 225.
40. Sollner, K., *Ann. N.Y. Acad. Sci.*, 1953, **57**, 177.
41. Carr, C. W., and Woods, K. R., *Arch. Biochem. Biophys.*, 1955, **55**, 1.
42. Carr, C. W., *Ibid.*, 1956, **62**, 476.
43. Gregor, H. P., and Sollner, K., *J. Phys. Chem.*, 1954, **58**, 409.
44. Wyllie, M. R. J., and Patnode, H. W., *J. Phys. Colloid Chem.*, 1950, **54**, 204.
45. Basu, A. S., *Sci. and Culture*, 1956, **21**, 447.

46. Sinha, S. K., *J. Indian Chem. Soc.*, 1955, **32**, 35.
47. Scatchard, G., Coleman, J. S., and Shen, A. L., *J. Amer. Chem. Soc.*, 1957, **79**, 12.
48. Peterson, E. A., and Sober, H. A., *Ibid.*, 1956, **78**, 751.
49. Sober, H. A., Gutter, F. J., Wyckoff, M. M., and Peterson, E. A., *Ibid.*, 1956, **78**, 756.
50. Mitz, M. A., and Yanari, S. S., *Ibid.*, 1956, **78**, 2649.
51. Champetier, G., Kelecsenyi-Dumesnil, E., Montegudet, G., and Petit, J., *Compt. Rend.*, 1956, **243**, 269.
52. Boardman, N. K., *Biochim. Biophys. Acta*, 1955, **18**, 290.
53. Feitelson, J., and Partridge, S. M., *Biochem. J.*, 1956, **64**, 607.
54. Abrams, I. M., *Ind. Eng. Chem.*, 1956, **48**, 1469.
55. Moore, S., and Stein, W. H., *Advanc. Prot. Chem.*, 1956, **11**, 191.
56. Sober, H. A., and Peterson, E. A., in Calmon, C., and Kressman, T. R. E., *Editors, op. cit.*, p. 318.
57. Kraus, K. A., Moore, G. E., and Nelson, F., *J. Amer. Chem. Soc.*, 1956, **78**, 2692.
58. Jentzsch, D., *Z. anal. Chem.*, 1956, **152**, 134.
59. Thomas, H. C., and Frysinger, G. R., *Ann. Rev. Phys. Chem.*, 1956, **7**, 137.
60. Genge, J. A. R., Holroyd, A., Salmon, J. E., and Wall, J. G. L., *Chem. & Ind.*, 1955, 357.
61. Genge, J. A. R., and Salmon, J. E., *J. Chem. Soc.*, 1957, 256.
62. Kember, N. F., Macdonald, P. J., and Wells, R. A., *Ibid.*, 1955, 2273.
63. Davies, C. W., and Owen, B. D. R., *Ibid.*, 1956, 1676.
64. Reichenberg, D., in Calmon, C., and Kressman, T. R. E., *Editors, op. cit.*, p. 178.
65. Lakshmanan, T. K., and Lieberman, S., *Arch. Biochem. Biophys.*, 1954, **53**, 258.
66. Nervik, W. E., *J. Phys. Chem.*, 1955, **59**, 690.
67. Grande, J. A., and Beukenkamp, J., *Anal. Chem.*, 1956, **28**, 1497.
68. Drake, B., *Ark. Kemi*, 1955, **8**, 1.
69. Freiling, E. C., *J. Amer. Chem. Soc.*, 1955, **77**, 2067.
70. —, *J. Phys. Chem.*, 1957, **61**, 543.
71. Piez, K. A., *Anal. Chem.*, 1956, **28**, 1451.
72. Asher, D. R., *Ind. Eng. Chem.*, 1956, **48**, 1465.
73. Asher, D. R., and Simpson, D. W., *J. Phys. Chem.*, 1956, **60**, 518.
74. Reichenberg, D., and Wall, W. F., *J. Chem. Soc.*, 1956, 3364.
75. Davies, C. W., and Owen, B. D. R., *Ibid.*, 1956, 1681.
76. Reichenberg, D., *Chem. & Ind.*, 1956, 958.
77. Sargent, R., and Rieman, W., *J. Org. Chem.*, 1956, **21**, 594.
78. —, *J. Phys. Chem.*, 1957, **61**, 354.
79. James, R. H., and Welch, G. A., *Nature*, 1956, **177**, 183.
80. Woodhead, J. L., Fudge, A. J., and Jenkins, E. N., *Analyst*, 1956, **81**, 570.
81. Dalton, J. C., and Welch, G. A., *Anal. Chim. Acta*, 1956, **15**, 317.
82. Perkins, R. W., *Anal. Chem.*, 1957, **29**, 152.
83. Mackereth, F. J. H., *Proc. Soc. Water Treatment and Examination*, 1955, **4**, 27.
84. Fujimoto, M., *Bull. Chem. Soc. Japan*, 1956, **29**, 646.
85. Kakihana, H., *Mikrochim. Acta*, 1956, 682.
86. Fujimoto, M., *Bull. Chem. Soc. Japan*, 1956, **29**, 600, 776, and 833; 1957, **30**, 274, 278, and 283.

Received August 13th, 1957

The Determination of Uranium by Solvent Extraction

Part I. The Separation of Uranium-233 from Irradiated Thorium as the Diethyldithiocarbamate Complex

By W. H. HARDWICK AND M. MORETON-SMITH

(Chemical Engineering Division, A.E.R.E., Harwell, nr. Didcot, Berks.)

The analytical separation of trace amounts of uranium by solvent extraction has been investigated, with particular reference to the determination of uranium-233 in irradiated thorium. The methods that have been evolved are applicable to the separation of uranium from many other elements under appropriate conditions. The use of *isobutyl methyl ketone* in conjunction with sodium diethyldithiocarbamate is described.

URANIUM-233 is produced by neutron irradiation of thorium as follows—

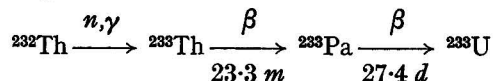

Uranium-233 itself decays by alpha emission with a half-life of 1.62×10^5 years. One microgram of the isotope gives 2.09×10^4 alpha disintegrations per minute and hence it

can be determined in trace amounts by alpha counting. The thermal-neutron capture cross-section for thorium-232 is 7 barns, so that the amount converted to uranium-233 in neutron fluxes of the order of 10^{12} neutrons per sq. cm per second is small. Irradiation for 1 year and then "cooling" for long enough to allow most of the protactinium-233 formed to decay to uranium-233 produces only 0.22 g of uranium-233 per kg of thorium. Fission products are also formed by the fission of a very small amount of the uranium-233. Hence the analytical control of a process in which these small amounts of uranium-233 are separated from irradiated thorium¹ will involve the determination of from 0.01 to 100 μg of uranium-233 per ml in approximately 0.7 *M* solutions of thorium nitrate. The solutions are also 0.05 *M* in fluoride ions to catalyse the dissolution of thorium metal or oxide. The accuracy required is from ± 10 to ± 2 per cent. at the 100 μg per ml level.

Before uranium-233 can be determined by alpha counting, it must first be separated from thorium, which would reduce the alpha count by absorption, and from the decay products of thorium, which would contribute to the alpha count.

The relative amounts of the daughter products of the decay of thorium will depend upon the interval between purification of the thorium before irradiation and the analysis. The total equilibrium alpha activity of the chain is about 1.8×10^4 disintegrations per minute per mg of thorium, or about 3×10^6 disintegrations per minute in 0.7 *M* solutions of thorium. This compares with 2.09×10^2 disintegrations per minute for 0.01 μg of uranium-233.

An excellent review of methods of analysis for uranium has been given by Rodden.² For the present requirements of rapid separation of traces of uranium-233, it seemed that a solvent-extraction procedure would be most suitable. Provided that it were simple enough, it would have the advantage of confining the uranium-233 and fission products to small volumes of liquids and would permit aliquots of the solvent phase containing the purified uranium-233 to be evaporated directly for alpha counting. The equipment required is very simple and this reduces the risk of radioactive cross-contamination.

EXPERIMENTAL

A solvent-extraction procedure that could separate trace amounts of uranium from large amounts of thorium in a single extraction was already available, based on the work of Betts and Cahn.³ This was the extraction by *isobutyl methyl ketone* (hexone) of the uranium-diethyldithiocarbamate complex from a thorium nitrate solution made 2 *M* in ammonium nitrate at pH 2.5 to 3.0. Unfortunately, the thorium daughters lead-212 (half-life 10.64 hours) and bismuth-212 (half-life 60.5 minutes) are also extracted. The alpha activity that results from the decay of the extracted bismuth-212 and from that bismuth-212 formed in the solvent by decay of lead-212 does not permit the determination of uranium-233 in the extract by counting until this unwanted activity has decreased to a relatively insignificant level. This requires at least 4 days, and much longer for very small amounts of uranium-233, and is therefore impractical for plant control. Neither lead nor bismuth is extracted by hexone, whereas uranium, and to a lesser extent thorium, is extracted by this solvent. A method was developed in which uranium is separated from lead and bismuth by extraction with hexone. The thorium that is extracted with the uranium is then separated by washing, under the conditions given above, after the addition of sodium diethyldithiocarbamate. A description of the experiments carried out to establish the four basic assumptions upon which the method depends is given below.

EXTRACTION OF URANIUM BY HEXONE FROM THORIUM NITRATE SOLUTIONS—

To achieve the highest extraction of uranium-233 it was proposed to saturate the aqueous phase with ammonium nitrate. In the absence of thorium nitrate, partition coefficients for uranium-233 (ratio of concentration in solvent phase to concentration in aqueous phase = K) for extraction from saturated ammonium nitrate solution into hexone at acidities of 0.25 and 0.5 *N* were measured by alpha counting. The values found for K_U were 14.5 and 12.5. The effect of thorium and nitric acid on K_U is indicated in Table I. It is apparent that three successive extractions with equal volumes of solvent are necessary to extract more than 98 per cent. of the uranium present in the solution initially 3 *N* in nitric acid, but measurements of extraction by nitric acid under these conditions showed K_{HNO_3} values of 1 and 2 for two successive extractions, and hence, after each extraction, the values of K_U will be improved owing to reduced acid concentrations. These values of K_U were high enough to meet the requirements for the proposed method.

TABLE I
EXTRACTION OF URANIUM AND THORIUM FROM SATURATED SOLUTIONS OF
AMMONIUM NITRATE BY HEXONE

Concentration of thorium,* mg per ml	Concentration of nitric acid,* N	K_U	K_{Th}
176	3.0	3.9	0.28
176	2.0	—	0.25
176	1.5	6.8	—
196	1.0	7.3	0.24
176	0.75	8.4	—
180	0.5	—	0.21
150	1.0	8.5	—
75	1.0	7.6	—
50	0.6	8.1	—

* The concentrations are for the aqueous phase before saturation with ammonium nitrate, which doubles the aqueous volume and halves these concentrations.

The extraction of thorium was measured in this and other experiments; typical results are included in Table I and show a value for K_{Th} of between 0.21 and 0.28. Three half-volume extractions would therefore remove about one-fifth of the thorium. For solutions of thorium containing 25 to 100 μg of uranium-233 per ml, 0.25-ml portions or less are adequate for an analysis, but for the lower range of concentrations of uranium-233, 5-ml portions are necessary to give enough uranium-233 alpha activity. The small portions can easily be diluted with saturated ammonium nitrate solution and nitric acid to give suitable volumes for extraction.

NON-EXTRACTION OF THORIUM DAUGHTERS BY HEXONE—

When thorium nitrate solutions containing daughter activities are equilibrated with hexone, some alpha activity is extracted. This activity does not show the decay characteristics of lead-212 or bismuth-212, but shows growth characteristics associated with thorium-232 and thorium-228. As shown later, this activity is removed at pH 2.8 by washing with an aqueous phase containing sodium diethyldithiocarbamate.

RETENTION OF URANIUM - DIETHYLDITHIOCARBAMATE COMPLEX IN HEXONE—

Control of pH—For the second stage of the analysis, uranium must be held in the hexone phase as the diethyldithiocarbamate complex while thorium is washed into the aqueous phase. Betts and Cahn⁸ found the optimum pH range was 2.5 to 3.0, since above pH 3.5 thorium begins to be precipitated and, under conditions of low pH, the uranium - diethyldithiocarbamate complex becomes unstable. An easy way to control the pH during washing was obviously desirable, and screened methyl orange was a suitable indicator. The hexone containing extracted uranium-233 and acid was stirred with 2 M ammonium nitrate solution and 1 drop of indicator was added. Concentrated ammonia solution was added dropwise until the indicator turned green. Then 0.5 ml of a freshly prepared and filtered solution of sodium diethyldithiocarbamate was added and 3 N nitric acid was added dropwise until the indicator assumed its intermediate colour. As stirring was continued, the pH sometimes rose and the indicator turned green. More acid was added to restore the intermediate colour.

Removal of alpha activity due to the presence of thorium—A 5-ml portion of a solution of thorium nitrate was saturated with ammonium nitrate and stirred with successive 5-ml portions of hexone. The hexone extracts were combined and washed with 2 M ammonium nitrate solution containing sodium diethyldithiocarbamate and the pH was controlled at 2.8 as described above. The solvent was then evaporated and the residue was destroyed with nitric acid, transferred to a tray, prepared for counting and counted. The mean alpha count of this solvent and of others from four similar experiments was equivalent to less than the 0.001 μg of uranium-233 per ml in the original sample. This was acceptable as the limit of alpha interference from thorium.

EVAPORATION OF HEXONE CONTAINING URANIUM-233 FOR ALPHA COUNTING—

When determining the higher concentrations of uranium-233, it is convenient to evaporate aliquots of the purified hexone extract directly on flat stainless-steel trays. The trays are

put on rings made of sections of copper tubing of diameter about 1 inch and $\frac{1}{2}$ inch long, which are placed on a hot-plate controlled by a Simmerstat. The trays are also heated from above by an infra-red lamp. To avoid loss by the solvent "creeping" over the edges of the tray, a technique was devised whereby 1 drop of a 20 per cent. solution of ammonium chloride containing about 1 per cent. of a water-soluble glue (Stephen's Stefix was used) is first placed on the tray and evaporated to dryness under the infra-red lamp. The hexone aliquot and washings from the pipette are added dropwise to the tray, which is kept hot enough to evaporate hexone without spitting. When the solvent aliquot and washings have been evaporated, the tray is heated to redness, thereby volatilising the ammonium chloride and organic matter. When this technique for evaporating the final solvent aliquot was used, recoveries ranged from 98 to 100 per cent.

RESULTS

In practice, duplicate analyses were carried out, and for the range of 30 to 100 μg of uranium-233 per ml, agreement between the duplicates was better than 2.5 per cent. In 80 per cent. of the analyses of solutions containing 0.1 μg per ml or less, agreement between duplicates was better than 5 per cent. The total time required for duplicate analysis, including counting, was about 3 hours. Although this time compares favourably with that required for other methods, such as chromatography, it was thought that the method might be improved by the introduction of ethylenediaminetetra-acetic acid to eliminate the preliminary extractions with hexone. This was only partly successful, but the substitution of 8-hydroxyquinoline for sodium diethyldithiocarbamate was satisfactory, and its use is described in Part II of this series.

METHOD

REAGENTS—

Hexone.

Ammonium nitrate, solid.

Ammonium nitrate solution, 2 M.

Sodium diethyldithiocarbamate solution—A freshly prepared and filtered 20 per cent. aqueous solution.

Ammonia solution, sp.gr. 0.880.

Nitric acid, concentrated and N.

Screened methyl orange indicator solution.

Anti-creeping solution—A 20 per cent. solution of ammonium chloride containing 1 per cent. of a water-soluble glue (Stephen's Stefix was found to be suitable).

PROCEDURE FOR 0.01 TO 1 μg OF URANIUM-233 PER ml—

By pipette place 5 ml of sample solution in a 40-ml centrifuge tube and saturate the solution with ammonium nitrate by adding the solid reagent. Then add 3 ml of hexone and stir the solution for 5 minutes. Spin in a centrifuge and then transfer the hexone layer to a clean 40-ml centrifuge tube. Repeat the extraction with two further 3-ml portions of hexone and combine the three hexone layers. To the combined layers add 5 ml of ammonium nitrate solution and 1 drop of screened methyl orange indicator solution and stir. Make alkaline by adding ammonia solution and then add 0.5 ml of sodium diethyldithiocarbamate solution. Add *N* nitric acid until the aqueous layer is mauve (not red) and stir for 4 to 5 minutes. If necessary, add more acid during this time to maintain the mauve colour.

Spin in a centrifuge and then transfer the hexone layer to a 50-ml beaker. Wash the surface of the aqueous layer with 0.5-ml portions of hexone and add the washings to the hexone in the beaker. Evaporate to dryness under gentle heat from an infra-red lamp in a fume chamber and wash the sides of the beaker twice with 2-ml portions of concentrated nitric acid, evaporating to dryness each time. Then wash the beaker twice with 4 drops of *N* nitric acid each time and transfer the washings to a stainless-steel counting tray. Evaporate the washings to dryness, heat the tray to redness in the flame of a Meker burner and then cool and count.

PROCEDURE FOR 1 TO 100 μg OF URANIUM-233 PER ml—

By pipette place a suitable aliquot of the sample solution in a 40-ml centrifuge tube (0.1 ml is suitable for 100 μg of uranium-233 per ml). Make up to approximately 1.5 ml

with *N* nitric acid and saturate the solution with ammonium nitrate by adding the solid reagent. Continue as for the procedure for 0.01 to 1 μg per ml up to the addition, if necessary, of more nitric acid to maintain the mauve colour.

Spin in a centrifuge and then transfer the hexone layer to a 10-ml calibrated flask, taking care to ensure that none of the aqueous layer is transferred. Wash the surface of the aqueous layer with three 0.5-ml portions of hexone and add the washings to the hexone in the flask. Make the volume in the flask up to the mark by adding hexone and mix thoroughly. Put 1 drop of anti-creeping solution into each of four stainless-steel counting trays and evaporate to dryness. By pipette put 0.25 ml of the hexone solution from the flask into each tray and slowly evaporate, keeping the hexone around the spot of ammonium chloride, and then add the washings from the pipette. Heat the trays to redness in the flame of a Meker burner and then cool and count.

REFERENCES

1. Nicholls, C. M., and Wells, I., "Progress in Nuclear Energy," Series III, Pergamon Press Ltd., London, 1956, Volume I, p. 223.
2. Rodden, C. J., *Anal. Chem.*, 1953, **25**, 1598.
3. Betts, R. H., and Cahn, R. P., National Research Council of Canada Report MX/219, 1946, classified.

Received May 22nd, 1957

The Determination of Uranium by Solvent Extraction

Part II. The Separation of Uranium-233 from Irradiated Thorium as the Oxine Complex in the Presence of Ethylenediaminetetra-acetic Acid

BY R. F. CLAYTON, W. H. HARDWICK, M. MORETON-SMITH AND R. TODD

(*Chemical Engineering Division, A.E.R.E., Harwell, nr. Didcot, Berks.*)

The development of solvent-extraction methods for determining trace amounts of uranium-233 in irradiated thorium is described. Thorium and its alpha-emitting daughters are complexed with EDTA, and, when uranium-233 is extracted as its diethyldithiocarbamate complex, only bismuth-212 accompanies it. This is immaterial for colorimetric or fluorimetric finishes, but, for determination of the uranium-233 by alpha counting, the bismuth-212 must first be allowed to decay. If, however, the uranium-233 is extracted as its 8-hydroxyquinoline complex, no alpha emitter accompanies it and concentrations of uranium-233 ranging from 100 μg per ml down to 0.01 μg per ml in 0.7 *M* thorium solution have been determined in this way.

In Part I of this series¹ a method of determining uranium-233 in irradiated thorium was described, in which uranium-233 was separated from thorium daughters by solvent extraction with *isobutyl methyl ketone* (hexone). Separation from thorium itself was completed by forming the uranium - diethyldithiocarbamate complex, which was retained in the solvent while the thorium was washed into the aqueous phase. It was thought that the method might be improved by the introduction of ethylenediaminetetra-acetic acid (EDTA), since this does not prevent the solvent extraction of uranium as its diethyldithiocarbamate complex, whereas thorium and interfering daughter activities are preferentially complexed by EDTA. Unfortunately, as Bode² has since reported, the bismuth - diethyldithiocarbamate complex is stronger than the bismuth - EDTA complex and, under the conditions for extracting uranium, the separated uranium-233 was found to be contaminated with alpha activity, owing to the presence of bismuth-212.

The problem was to find a complexing agent that would form a strong solvent-soluble complex with uranyl ions, but any complexes formed with thorium and daughter alpha emitters must be weaker than their respective EDTA complexes. Di- and tri-*n*-butyl phosphates were tried, but were found to be unsatisfactory.

* Pribil and Malát³ had reported that only uranium, titanium, vanadium, molybdenum and tungsten are precipitated by 8-hydroxyquinoline (oxine) in the presence of EDTA from an acetic acid - ammonium acetate buffer. Solvent extraction of the uranium complex

appeared promising under these conditions, and experiments were carried out to establish the optimum conditions for determining small concentrations (0.01 to 100 μg per ml) of uranium-233 in thorium nitrate solutions, after the addition of EDTA, by extraction with oxine dissolved in either hexone or chloroform. These experiments are described and the analytical methods that were evolved are given in detail, together with results obtained on a number of solutions during routine use of the methods.

EXPERIMENTAL

All equilibrations were carried out in 40-ml centrifuge tubes, the two phases being mixed by stirring for 5 minutes. After centrifuging, samples of the solvent phase were evaporated on stainless-steel counting trays by using the technique described by Bode.² Counting was then carried out for 10 minutes or for a total of 10,000 counts by using an alpha-scintillation counter.

EXTRACTION WITH SODIUM DIETHYLDITHIOCARBAMATE DISSOLVED IN HEXONE IN PRESENCE OF EDTA—

The experiments carried out to test the efficiency of EDTA as a "masking" agent for thorium-chain alpha activities during the extraction of uranium as its diethyldithiocarbamate complex showed that the extraction of uranium is quantitative even in the presence of thorium and excess of EDTA. Unfortunately, the thorium daughter, bismuth-212, is also extracted and must be allowed to decay before determination of uranium-233 by counting; this time lag will depend on the relative amounts of thorium and uranium originally present and on the accuracy required. When the necessary time lag is permissible, this method is very satisfactory; it has all the advantages of the original procedure,¹ e.g., thin sources are obtained, but is much simpler. For fluorimetric or colorimetric finishes, i.e., for microgram or milligram amounts of natural uranium, the presence of bismuth-212 is immaterial.

EXTRACTION WITH OXINE DISSOLVED IN CHLOROFORM OR HEXONE—

The use of oxine was next investigated, since uranium is precipitated by oxine in the presence of EDTA, but bismuth and thorium are not.³ According to Welcher,⁴ quoting results by Goto, Fleck and Ward, in the absence of EDTA, uranium is completely precipitated by oxine in the pH range 4.1 to 8.8, whereas bismuth is completely precipitated in the pH range 4.5 to 10.5. Below pH 4.5, complexing of bismuth by oxine is incomplete and its retention in the aqueous phase as the EDTA complex is more likely. So experiments were carried out at pH 4.1 to see if thorium-chain activities were extracted by oxine solutions in the presence of EDTA, and, if not, whether uranium itself were quantitatively extracted.

PRELIMINARY EXPERIMENTS—

A solution containing 200 mg of thorium as nitrate and 400 mg of the dihydrated disodium salt of EDTA, a molar ratio of 1 to 1.25, was adjusted to pH 4.1 and stirred with a 2.5 per cent. w/v solution of oxine in chloroform. Portions of the solvent phase were evaporated and no alpha activity was detected. The experiment was repeated with added uranium-233 and showed that about 91 per cent. of the uranium was extracted. The results were similar when a 2.5 per cent. solution of oxine in hexone was used. With an initial aqueous phase containing 18 mg of thorium at pH 4, recoveries of uranium-233 were 100 and 102 per cent. by using oxine dissolved in hexone and in chloroform.

THE EFFECT OF pH ON THE EXTRACTION OF THORIUM-CHAIN ALPHA ACTIVITY—

To assess the effect of pH on the extraction of thorium-chain alpha emitters, 50 ml of a solution containing 180 mg per ml of thorium in nitric acid was treated with a solution of the tetrasodium salt of EDTA, the molar ratio of thorium to EDTA being 1 to 1.25. The thorium-EDTA solution was then adjusted to pH 10 and stirred with 20 ml of a 2.5 per cent. solution of oxine in chloroform. The solvent phase was sampled as the pH was reduced in unit stages. At pH 10 and pH 9 the solvent activities were 24 and 39 disintegrations per minute per ml, respectively, but from pH 8 down to pH 2 the solvent activity was 6 disintegrations per minute per ml, equivalent to only 3×10^{-4} μg of uranium-233 per ml. The aqueous activity was approximately 2×10^5 disintegrations per minute per ml.

THE EFFECT OF pH ON THE EXTRACTION OF URANIUM-233—

The preliminary extraction of uranium-233 with oxine had indicated that a pH of 4.1 was satisfactory. A sample of dissolved irradiated thorium rod solution designated No. 3977

was analysed. Portions of 0.25 ml were diluted with a solution of the tetrasodium salt of EDTA and water and the pH was adjusted to 4.1, the final volume of the solution being about 2 ml. Five millilitres of a 2.5 per cent. solution of oxine in hexone or in chloroform were used as the solvent. The results of duplicate experiments are given in Table I. This sample was also analysed by extraction with a solution of sodium diethyldithiocarbamate in hexone and by extraction with a solution of sodium diethyldithiocarbamate in hexone in the presence of EDTA, the bismuth-212 being allowed to decay.

TABLE I

ANALYSIS OF SAMPLE NO. 3977 BY DIFFERENT METHODS

The aqueous phase contained 354 mg of thorium per ml and 56 μg of uranium-233 per ml; 0.25-ml portions of the solvent phase were taken for each determination

Solvent phase	Uranium-233 found, μg per ml
Oxine in hexone	55.5 \pm 1.7
Oxine in chloroform	56.9 \pm 2.2
Sodium diethyldithiocarbamate in hexone ..	53.5 \pm 1.5
Sodium diethyldithiocarbamate in hexone in presence of EDTA	55.0 \pm 1.5

These results were encouraging. To obtain an indication of the precision and accuracy of the procedure, ten individual analyses were carried out on one sample made up to contain 100 μg of uranium-233 per ml and 150 mg of thorium per ml; 100- μl portions were taken and 80 mg of EDTA were added to each aqueous phase, the molar ratio of thorium to EDTA being 1 to 3.3. Four portions of each solvent phase were counted. The mean recovery was 99.5 per cent., with a coefficient of variation of 1.6 per cent.

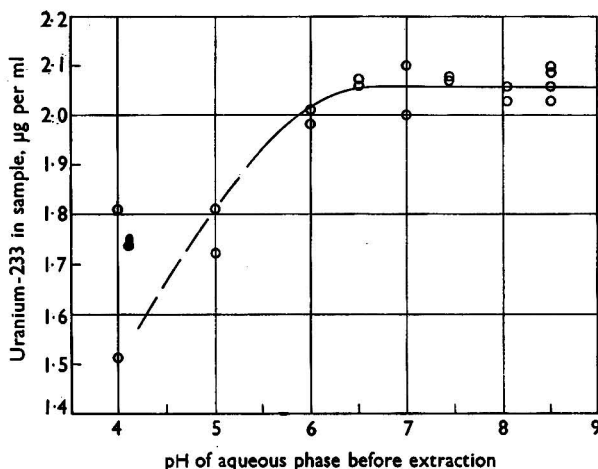

Fig. 1. Extraction of uranium-233 from thorium nitrate solutions by means of a 2.5 per cent. solution of oxine in hexone (0.17 M) as a function of pH. The concentrations of uranium and thorium were $10^{-5} M$ and $1.3 \times 10^{-3} M$, respectively

However, further analyses showed much wider variations and it was thought advisable to investigate the effect of pH on the extraction. A solution was made up to contain about 2 μg of uranium-233 per ml, 3 mg of thorium per ml, 0.06 N nitric acid and 19 mg of EDTA per ml, the molar ratio of thorium to EDTA being 1 to 4. The experiment was carried out by first adjusting the solution to pH 4.1, and then two 5-ml portions were removed. These were extracted with 5 ml of a 2.5 per cent. solution of oxine in hexone. The pH of the solution was then raised to 5.0, when two more 5-ml portions were removed and extracted with the solution of oxine in hexone. The pH was raised in steps to 8.5 and samples were taken for extraction at each stage. The results are shown graphically in Fig. 1 and they indicate that the extraction reaches a maximum at pH 6 and is constant above this value. No extractions

were carried out above pH 8.5. It should be noted that the addition of the solvent causes a drop in pH, and the aqueous phase, initially at pH 8.5, fell to pH 7.9 during extraction.

The fall in recovery that begins as the pH falls below 6 is surprising in view of many satisfactory results obtained at pH 4.1. The recoveries from high concentrations of thorium of sub-microgram amounts of uranium-233 are variable at lower pH values, but are apparently consistent above pH 6. The low recoveries as the pH falls below 7 are discussed later in relation to the complexing of uranium by EDTA.

The application of the method to the determination of sub-microgram amounts of uranium-233 in 0.7 *M* thorium solution had likewise given inconsistent results at pH 4. At pH 6.5, however, complete recovery could be effected provided that adequate volumes of solvent and concentrations of oxine were used. Results of a number of experiments are given in Table II. By using 2 ml of a 10 per cent. solution of oxine in chloroform, recoveries from 3 ml of a solution containing 0.05 μg of uranium-233 per ml and 180 mg of thorium per ml were satisfactory.

Hexone is a more convenient solvent than chloroform, since it is lighter than the aqueous phase and the extracted uranium-233 is separated in the upper layer. After centrifuging, portions of the solvent can be measured by pipette directly without fear of contamination by the aqueous phase. A number of analyses were accordingly carried out with hexone as the solvent. During the adjustment of pH, hexamethylenetetramine was added to the slightly acid solution to buffer the pH at 6.5. This was not really necessary, however, since at these concentrations of thorium and EDTA, the solutions themselves are quite strongly buffered. Two 0.25-ml portions of each solvent phase were taken for counting, but were only counted for 10 minutes and gave about 1300 counts each. In view of this, the results that are summarised in Table I show that the accuracy and precision obtained are satisfactory.

TABLE II

EFFECT OF VARIATIONS OF THE CONCENTRATIONS OF OXINE AND THORIUM ON THE DETERMINATION OF SUB-MICROGRAM AMOUNTS OF URANIUM-233

Extraction No.	Volume of solution containing 180 mg of thorium per ml used, ml	Thorium present, mg	Solvent	Volume of solvent used, ml	Concentration of oxine in solvent, %	Recovery, %
4 a	1	180	chloroform	2	2.5	68, 74
4 b	1.5	270	chloroform	2	2.5	50, 36
4 c	2	360	chloroform	2	2.5	24, 24
4 d	2	360	chloroform	5	2.5	104, 96
4 e	2	360	chloroform	2	10.0	108, 108
4 f	2	360	hexone	5	2.5	60, 72

Single analysis, volume of solvent 2 ml, oxine concentration 10 per cent.—

Extraction No.	Volume of solution containing 180 mg of thorium per ml used, ml	Thorium present, mg	Recovery, %
4 g	5	900	42
4 h	5	900	50
4 i	4	720	80
4 j	3	540	98
4 k	3	540	102
4 l	3	540	94
4 m	3	540	78
4 n	3	540	102
4 o	3	540	100
4 p	3	540	102

EXTRACTION OF SUB-MICROGRAM AMOUNTS OF URANIUM-233 FROM CONCENTRATED THORIUM SOLUTIONS—

Uranium-233 was determined by extraction with either a solution of oxine in chloroform or in hexone from an aqueous phase containing initially 180 mg of thorium per ml, 0.05 μg of uranium-233 per ml and 3 *N* nitric acid. An excess of a solution of the tetrasodium salt of EDTA was added and the pH of the solution was adjusted to 6.5, the final volume of the aqueous phase being about 5 ml. The results are shown in Table II. The accuracy and

precision of the method for sub-microgram amounts of uranium-233 by extraction with 2 ml of a 10 per cent. solution of oxine in hexone were determined by a further series of tests in which the conditions were the same as for extractions 4 *k* to 4 *p* in Table II, except that hexone was used as the solvent. The mean counting rate of the solvent phase was 516 counts per minute per ml (10-minute counts), the coefficient of variation was 6.5 per cent. and the mean recovery was 99.2 per cent.

EFFECT OF THE CONCENTRATION OF OXINE AND THE VOLUME OF THE SOLVENT PHASE ON THE EXTRACTION OF URANIUM-233—

As can be seen from Table II, the recovery of small amounts of uranium-233 from thorium nitrate solutions depends upon both the volume of the solvent used and the concentrations of oxine. Tables IIIA, IIIB, IIIC and IIID give the results of analyses carried out on solutions of four irradiated thorium rods under a variety of conditions, together with the results of extractions with a solution of sodium diethyldithiocarbamate in hexone.

TABLE IIIA

RESULTS OF ANALYSES OF SOLUTION OF IRRADIATED THORIUM METAL IN NITRIC ACID, SAMPLE NO. 3977

Ratio of EDTA to thorium was 1 to 5. Final volume of aqueous phase was 2 ml, containing 354 mg of thorium per ml

Analysis No.	Volume of sample solution taken, ml	Solvent	Volume of solvent, ml	Concentration of oxine in solvent, % w/v	Number of 250- μ l portions prepared and counted	Spread of counts, %	Uranium-233 found, μ g per ml
1	0.1	chloroform	2	2.5	3	1	67.4
2	0.1	chloroform	2	2.5	2	1	63.1
3	0.1	chloroform	2	2.5	3	4	59.8
4	0.1	chloroform	2	2.5	3	2	61.2
5	0.1	chloroform	2	2.5	4	5	59.1
6	0.1	chloroform	2	2.5	4	7	59.5
7	0.5	chloroform	5	2.5	2	8	55.5
8	0.1	hexone	2	2.5	2	1	56.0
9	0.1	hexone	5	2.5	3	1	56.4
10	0.1	hexone	5	2.5	3	3	56.7
11	0.1	hexone	5	2.5	3	4	55.6
12	0.1	hexone	5	2.5	3	1.5	57.2
13	0.1	hexone	5	2.5	3	1	56.5
14	0.1	hexone	5	2.5	3	1	56.0
15	0.1	hexone	5	2.5	3	1	54.8
16	0.1	hexone	5	2.5	3	1	56.7
17	0.1	hexone	5	2.5	3	1	55.5
18	0.1	hexone	5	2.5	3	2	55.7
19	0.1	hexone	5	2.5	2	1	56.6
20	0.25	hexone	5	2.5	3	4	57.1
21	0.25	hexone	5	2.5	2	4.5	55.5
22	0.25	hexone	5	2.5	2	1.25	55.5
23	0.25	hexone	5	2.5	3	1	55.5
24	0.25	hexone	5	2.5	3	5	55.7
25	0.1	hexone	2	10.0	5	5	57.5*
26	0.1	hexone	2	10.0	3	1	59.8*
27	0.1	hexone	2	10.0	3	1	59.4*
28	0.1	hexone	2	10.0	3	1	57.1*

Mean of results 9 to 24 = 56.1 μ g per ml.

Standard deviation = ± 0.7 μ g per ml = ± 1.2 per cent.

Precipitate formed in aqueous phase.

The results, including those for sample No. 5354, are plotted in Fig. 2 and show that recovery is complete when 5 ml of a 2.5 per cent. solution of oxine in hexone or chloroform are used. With 10 per cent. solutions of oxine in hexone, precipitation occurs at these low concentrations of thorium, and, with 10 per cent. solutions in chloroform, the recoveries apparently in excess of 100 per cent. are probably due to evaporation of the solvent.

TABLE IIIB

RESULTS OF ANALYSES OF A SOLUTION OF IRRADIATED THORIUM METAL IN
NITRIC ACID, SAMPLE NO. 5352Ratio of EDTA to thorium was 1 to 5. Final volume of aqueous phase was 2 ml,
containing 304 mg of thorium per ml

Analysis No.	Volume of sample solution taken, ml	Solvent	Volume of solvent, ml	Concentration of oxine in solvent, % w/v	Number of 250- μ l portions prepared and counted	Spread of counts, %	Uranium-233 found, μ g per ml
1	0.1	chloroform	2	2.5	3	6	56.9
2	0.1	chloroform	2	2.5	3	2	57.4
3	0.1	hexone	2	2.5	—	—	49.1*
4	0.1	hexone	2	2.5	—	—	51.5*
5	0.1	hexone	2	2.5	—	—	48.3*
6	0.1	hexone	2	2.5	—	—	49.4*
7	0.1	hexone	2	2.5	—	—	53.2*
8	0.1	hexone	2	2.5	—	—	52.2*
9	0.1	hexone	2	10.0	3	1	57.0†
10	0.1	hexone	5	2.5	3	1	53.2
11	0.1	hexone	5	2.5	3	3	52.9
12	0.1	hexone	5	2.5	3	1	54.2
13	0.1	hexone	5	2.5	3	1	54.2
14	0.1	hexone	5	2.5	3	1	51.5
15	0.1	hexone	5	2.5	3	1	55.4
16	0.1	chloroform	5	2.5	3	10	53.1
17	0.1	chloroform	5	2.5	3	4	55.5
18	0.1	chloroform	5	2.5	3	12	51.2
19	0.1	chloroform	5	2.5	3	3	52.5
20	0.1	chloroform	5	2.5	3	7	55.9
21	0.1	chloroform	5	2.5	2	1	53.1
22	0.1	chloroform	5	2.5	3	8	53.3
23	0.1	chloroform	5	2.5	3	8.5	53.2
24	0.1	chloroform	5	2.5	3	6	54.5

Mean of results 10 to 24 = 53.6 μ g per ml.Standard deviation = ± 1.3 μ g per ml = ± 2.4 per cent.

* Solvent removed with washings and made up to 25 ml.

† Precipitate formed in aqueous phase.

TABLE IIIC

RESULTS OF ANALYSES OF A SOLUTION OF IRRADIATED THORIUM METAL IN
NITRIC ACID, SAMPLE NO. 5354Ratio of EDTA to thorium was 1 to 5. Final volume of aqueous phase was 2 ml,
containing 350 mg of thorium per ml

Analysis No.	Volume of sample solution taken, ml	Solvent	Volume of solvent, ml	Concentration of oxine in solvent, % w/v	Number of 250- μ l portions of solvent prepared and counted	Spread of counts, %	Uranium-233 found, μ g per ml
1	0.1	hexone	2	2.5	3	7	50.7
2	0.1	hexone	2	2.5	2	1	58.9
3	0.1	hexone	2	2.5	3	1	52.4
4	0.1	hexone	2	2.5	3	3	55.5
5	0.1	hexone	3	2.5	3	2	58.8
6	0.1	hexone	4	2.5	33	2.5	61.7 ^o
7	0.1	hexone	5	2.5	3	1	64.6
8	0.1	hexone	5	2.5	2	3	63.1
9	0.1	hexone	7	2.5	2	2	61.7
10	0.1	hexone	10	2.5	2	3	64.1
11	0.25	sodium diethyldithiocarbamate in hexone in presence of EDTA			—	—	63.6 ^o

Mean of results 7 to 11 = 63.4 μ g per ml.

TABLE III D

RESULTS OF ANALYSES OF A SOLUTION OF IRRADIATED THORIUM METAL IN NITRIC ACID, SAMPLE NO. 5355

Ratio of EDTA to thorium was 1 to 5. Final volume of aqueous phase was 2 ml, containing 321 mg of thorium per ml

Analysis No.	Volume of sample solution taken, ml	Solvent	Volume of solvent, ml	Concentration of oxine in solvent, % w/v	Number of 250- μ l portions of solvent prepared and counted	Spread of counts, %	Uranium-233 found, μ g per ml
1	0.1	hexone	2	2.5	2	2.5	46.1
2	0.1	hexone	2	2.5	3	1.5	48.8
3	0.1	hexone	2	2.5	3	2.0	47.2
4	0.1	hexone	5	2.5	2	—	50.3
5	0.25	sodium diethyldithiocarbamate in hexone in presence of EDTA	—	—	—	—	50.2

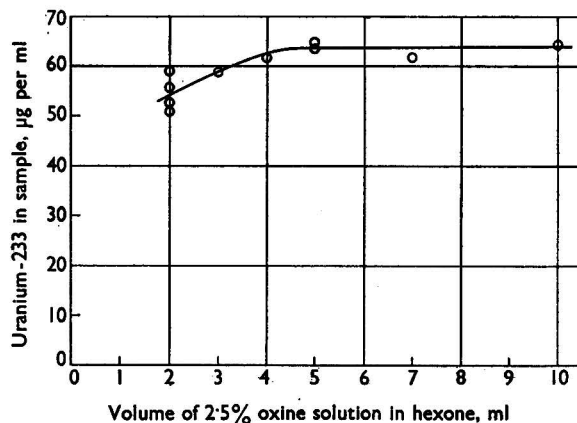
Mean of results 4 and 5 = 50.2 μ g per ml.Fig. 2. Recovery of uranium-233 from sample No. 5354, which contained 63.4 μ g per ml, as a function of volume of solvent

From these experiments, it appears that, for high ratios of uranium-233 to thorium, when an aliquot containing less than 50 mg of thorium is adequate, 5 ml of a 2.5 per cent. solution of oxine in hexone is the optimum volume of solvent. With very low concentrations of uranium-233, 2 ml of a 10 per cent. solution of oxine in hexone is preferable, since this gives a solvent phase of higher specific activity. Sufficient counts can then be obtained from the evaporation of two or more 0.25-ml portions directly on counting trays, rather than by the destruction of much larger portions by the procedure described in Part I of this series.¹ This saves much time and the possibly lower accuracy that results from working with small volumes of concentrated oxine solution is negligible at these levels.

EXTRACTION OF URANIUM-233 IN THE PRESENCE OF FLUORIDE IONS—

It is usual to add fluoride ions to about 0.05 *M* to catalyse the solution of thorium or thorium in nitric acid.⁵ Many of the analyses described earlier, such as those in Table III, were carried out on such solutions. The possible interference of fluoride ions was tested by carrying out duplicate determinations of uranium-233 in the presence of various concentrations of fluoride ions. The solvent phase was 5 ml of a 2.5 per cent. solution of oxine in hexone and the aqueous phase was 0.1 ml of thorium nitrate solution, diluted to 5 ml and containing 101 μ g of uranium-233 per ml and EDTA, the results being as follows—

Initial concentration of fluoride ions, <i>M</i>	0	0.05	0.1	0.5
Uranium-233 found, μ g per ml	100, 104	101, 102	102, 104	103, 103

With 3 ml of a solution containing 180 mg of thorium per ml and 0.05 μg of uranium-233 per ml and which was made 0.5 M in fluoride ions in the presence of excess of EDTA, 84 and 86 per cent. of the total of 0.15 μg of uranium-233 was recovered in duplicate determinations. Since this concentration of fluoride is ten to twenty-times greater than is encountered in practice, and since no effect has been observed with fluoride ions at 0.03 to 0.05 M , it may be concluded that fluoride ions do not interfere at the higher concentration levels and that at very low concentrations of uranium-233 their effect is negligible.

EFFECT OF EDTA ON THE EXTRACTION OF URANIUM-233—

It was found that, with solutions of diethyldithiocarbamate in hexone at pH 2.5, EDTA did not interfere with the extraction of microgram amounts of uranium. Similar experiments with oxine in hexone were carried out, in which 2-ml portions of a solution containing only uranium-233 and different amounts of EDTA were extracted with 2-ml portions of a 2.5 per cent. solution of oxine in hexone at pH 7. The amount of uranium-233 present was 20 μg and the results, which show that there was no interference by EDTA up to a total of 80 mg (0.11 M), were as follows—

Concentration of disodium salt of EDTA in aqueous phase, mg per ml	0	8	16	40
Uranium-233 found, μg	20.3	20.0	20.9	20.1

Cabell⁶ showed that a weak complex was formed between uranyl ions and EDTA in acid solution, but he did not determine the stability constant of the complex. Further, over the pH range in which we are interested, *i.e.*, 4.1 to 6.5, his curve for the titration of the complex with alkali showed a steadily increasing rate of consumption of hydroxyl ions, which indicates considerably less hydrolysis of the complex in the lower part of this range. Thus in this lower pH region, the stability of the complex may be sufficiently great for complexing by EDTA to compete with complexing by oxine. Recoveries will be expected to decrease with decreasing pH and increasing concentration of EDTA.

To test this hypothesis, experiments were carried out in which both pH and concentration of EDTA were varied. A series of solutions containing 2 μg of uranium-233 per ml was treated with increasing amounts of the disodium salt of EDTA and the solutions were adjusted to pH 4.1; another series was treated likewise but adjusted to pH 7. In each series the amount of uranium-233 extracted by a solution of oxine in hexone decreased with increasing EDTA concentration. For 90 mg of EDTA per ml at pH 7, 78 per cent. of the uranium-233 was extracted, but only 20 per cent. was extracted at pH 4.1. These very low recoveries were in marked contrast with the results given in Table II, from which it can be seen that extraction was 100 per cent. at pH 6.5 in the presence of 100 mg of thorium per ml and an excess of EDTA of as much as 140 mg per ml. An explanation is readily found; according to Cabell,⁶ the thorium - mono EDTA complex will bind a further molecule of EDTA (Y)—

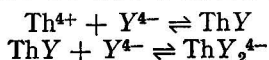

Provided that the second molecule of EDTA (Y) is sufficiently strongly bound under the prevailing pH conditions, complete extraction of the uranium should then be realised at all concentrations of EDTA up to that corresponding to a molar ratio with thorium of 2 to 1.

ACCURACY AND PRECISION OF THE METHOD

The results given in Table III, which were obtained under conditions that are accepted as being reliable, show standard deviations of ± 1.2 and ± 2.4 per cent. An earlier test on sample No. 3977, although at pH 4, had shown a standard deviation of ± 1.6 per cent. No other tests of precision were carried out, but, in the use of the method for plant control, agreement between duplicate analyses was better than 2 per cent. in 80 per cent. of the analyses carried out at the 100 μg per ml level, while at sub-microgram levels, agreement was better than 10 per cent. No systematic error has revealed itself.

The method is rapid, a duplicate analysis at sub-microgram levels taking only 2 hours, of which 1 hour is occupied in alpha counting. The latter operation is done automatically.

DISCUSSION OF RESULTS

It has been shown that a solution of oxine in chloroform or hexone can quantitatively extract sub-microgram to milligram amounts of uranium from a solution containing thorium

and its daughters, while the latter elements are held in the aqueous phase as their EDTA complexes. Drysen and Dahlberg⁷ have studied the extraction of uranium from perchlorate solutions by solutions of oxine in hexone and in chloroform, and it may be estimated from their data that extraction into the solvent phase when a 2.5 per cent. solution of oxine is used as the solvent should be complete above pH 3.5. In all experiments, recovery was complete at pH 4.1 in the absence of EDTA, and often recovery was complete at pH 4.1 from thorium solutions containing EDTA. It is probable that low results at pH 4.1 were due to interference by EDTA, when the amount of EDTA added was in excess of that which could form complexes with the thorium present. In the experiment to determine the effect of pH on the extraction of uranium-233 in the presence of thorium and EDTA, the molar ratio of EDTA to thorium was 3 to 1 and extraction was incomplete below pH 6. However, in the ten extractions to test the precision of the method there was a molar ratio of EDTA to thorium of 3 to 1, but the volume of the aqueous phase was made up to 5 ml, which gave a concentration of EDTA of 20 mg per ml. Interference by EDTA is reduced by raising the pH and complete extraction is readily achieved at higher pH values provided that the amount of EDTA added is not too great. A 10 per cent. excess above equimolar proportions appears to be quite satisfactory and is recommended, although much larger excesses can be tolerated.

TABLE IV

EFFECT OF EDTA ON THE EXTRACTION OF URANIUM IN THE ABSENCE OF THORIUM

Five-millilitre portions of aqueous stock solution were extracted with 5 ml of a 2.5 per cent. solution of oxine in hexone

Volume of aqueous stock solution, ml	Weight of EDTA added, mg	Concentration of EDTA, mg per ml	pH of stock solution before sampling	Uranium-233 found, μg per ml
<i>Experiment A—</i>				
50	—	—	4.1	2.0
40	270	6.8	4.1	1.95
30	2500	90	4.1	0.39
20	—	90	7	1.56
<i>Experiment B—</i>				
50	300	6	7	2.07
40	1300	38.5	7	2.0
30	1300	82	7	1.85
20	1300	137	7	1.45

Extraction with oxine is obviously applicable to other uranium isotopes. When the isotope is of low specific activity, *e.g.*, uranium-238, it may be determined after separation by other methods, such as fluorimetry or colorimetry. For a fluorimetric finish, a portion of the solvent should be evaporated on a clean platinum dish before fusion with sodium fluoride. It is hoped to describe the use of extraction with oxine for the determination of uranium in the presence of other metals, such as bismuth, in Part III of this series.

The use of EDTA in the extraction with a solution of diethyldithiocarbamate in hexone does not prevent bismuth-212 entering the solvent phase, but when the uranium in the solvent is to be determined by methods other than counting this is no disadvantage. Also, when the delay necessary for bismuth-212 to decay is allowable, this represents a very simple and accurate method for determining uranium-233 in thorium solutions.

DISCUSSION OF THE DETERMINATION OF URANIUM-233 BY COUNTING

King and Jackson⁸ have shown that uranium-232 is likely to be present in uranium-233 produced by neutron irradiation of thorium. They point out, for example, that if a thorium ore has contained uranium-238, then its daughter thorium-230 (ionium) will be present in the separated thorium and thorium-230 produces uranium-232 by successive neutron capture as follows—

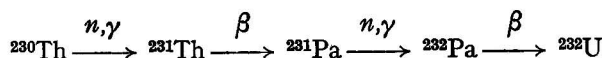

Uranium-232 is an alpha emitter and decays with a half-life of 70 years to give thorium-228, a member of the thorium-232 decay chain. Hence a process that has separated uranium-233 from thorium containing uranium-232 will give a product whose apparent specific activity

will slowly increase because of the growth of thorium-228 and its daughters. King and Jackson have also demonstrated that a specimen containing as little as 0.002 atom per cent. of uranium-232 may show as much as 2 per cent. contamination 1 year after separation.

The analytical methods described separate uranium from thorium and its daughters and the alpha activity of the oxine in hexone phase is due only to uranium isotopes. This has been confirmed by alpha pulse analysis carried out by Mrs. K. M. Glover. However, in experiments in which uranium-233 is used as a tracer and when concentrations are determined by direct alpha counting, without separation from possible thorium contamination, errors may arise.

METHOD FOR DETERMINING URANIUM-233 IN THORIUM NITRATE SOLUTIONS
BY EXTRACTION WITH OXINE

REAGENTS—

Oxine solution A—A 10 per cent. w/v solution of 8-hydroxyquinoline in *isobutyl methyl ketone*.

Oxine solution B—A 2.5 per cent. w/v solution of 8-hydroxyquinoline in *isobutyl methyl ketone*.

EDTA solution—Dissolve 372.9 g of the disodium salt of ethylenediaminetetra-acetic acid in 500 ml of water containing 80 g of sodium hydroxide and make up to 1 litre.

1 ml \equiv 232 mg of thorium.

Nitric acid, N.

Ammonia solution, sp.gr. 0.880.

Ammonia solution, 0.2 N.

Bromothymol blue indicator solution.

Anti-creeping solution—A 20 per cent. solution of ammonium chloride containing 2 per cent. of a water-soluble glue (Stephen's Stefix was found to be suitable).

PROCEDURE FOR 0.01 TO 1 μ g OF URANIUM-233 PER ml—

With a pipette place a suitable volume of sample solution, containing not more than 600 mg of thorium, in a 40-ml centrifuge tube fitted with a glass stirrer. Add EDTA solution to give about a 10 per cent. excess over the thorium equivalent and then add 3 drops of bromothymol blue indicator solution.

Add ammonia solution, sp.gr. 0.880, until the indicator turns blue. Return the colour of the indicator to yellow by adding *N* nitric acid and then add 0.2 *N* ammonia solution until the colour of the indicator just turns back to blue (pH 7). Add 2 ml of oxine solution A, stir for 5 minutes, spin in a centrifuge to separate the phases and then stopper the tube.

Evaporate duplicate 0.25-ml portions of the solvent phase slowly on stainless-steel counting trays that have had 1 drop of anti-creeping solution evaporated at their centres.¹ Heat the trays to redness in the flame of a Meker burner, cool and count.

PROCEDURE FOR 1 TO 100 μ g OF URANIUM-233 PER ml—

With a pipette place a suitable volume of sample solution, containing about 10 μ g of uranium-233, in a 40-ml centrifuge tube and dilute to 3 ml with water. Add EDTA solution to give a 10 per cent. excess over the thorium equivalent. Add 2 drops of bromothymol blue indicator solution and adjust the pH to 7 as previously described.

Add 5 ml of oxine solution B, stir for 5 minutes, spin in a centrifuge to separate the phases and then stopper the tube. Evaporate duplicate 0.1 or 0.25-ml portions of the solvent phase for counting, as before.

Note that for a fluorimetric finish to either procedure, suitable duplicate portions of the solvent phase should be evaporated in platinum fluorimeter dishes before fusion with sodium fluoride.

METHOD FOR DETERMINING URANIUM-233 IN THORIUM NITRATE SOLUTIONS
BY EXTRACTION WITH SODIUM DIETHYLDITHIOCARBAMATE

REAGENTS—

Hexone.

Sodium diethyldithiocarbamate solution—A freshly prepared and filtered 20 per cent. w/v aqueous solution.

EDTA solution—Prepared as described in reagents list, p. 22.

Ammonium nitrate solution, 2 M.

Ammonia solution, *p.gr.* 0.880.

Nitric acid, concentrated and N.

Screened methyl orange indicator solution.

Anti-creeping solution—A 20 per cent. solution of ammonium chloride containing 1 per cent. of a water-soluble glue.

PROCEDURE FOR 1 TO 100 μg OF URANIUM-233 PER ml—

With a pipette place a suitable volume of sample solution, containing about 10 μg of uranium-233, in a 40-ml centrifuge tube fitted with a glass stirrer. Dilute to 4-ml with 2 M ammonium nitrate and add EDTA solution to give a 10 per cent. excess over the thorium equivalent. Stir and make just alkaline to screened methyl orange by adding ammonia solution and then add 0.5 ml of sodium diethyldithiocarbamate solution.

Stir and add *N* nitric acid until the solution is mauve (not red). Add 5 ml of hexone, stir for 5 minutes and add more acid to maintain the mauve colour if necessary. Spin in a centrifuge to separate the phases and then stopper the tube.

Evaporate suitable duplicate portions of the solvent phase on stainless-steel counting trays that have had 1 drop of anti-creeping solution evaporated at their centres. Heat the trays to redness in the flame of a Meker burner, allow the bismuth-212 to decay, and then count. Alternatively, for a fluorimetric finish, evaporate duplicate portions of the solvent phase in platinum fluorimeter dishes for fusion with sodium fluoride.

Note that greater sensitivity can be obtained by starting with a larger volume of sample or by evaporating larger portions of the solvent phase.

REFERENCES

1. Hardwick, W. H., and Moreton-Smith, M., *Analyst*, 1958, **83**, 9.
2. Bode, H., *Z. anal. Chem.*, 1955, **144**, 165.
3. Přebil, R., and Malát, M., *Coll. Czech. Chem. Comm.*, 1950, **15**, 120.
4. Welcher, F. J., "Organic Analytical Reagent," D. Van Nostrand Co. Inc., New York, 1947, Volume I, p. 266.
5. Seaborg, G. T., and Katz, J. J., "The Actinide Elements," McGraw-Hill Book Co. Inc., New York, 1954, p. 176.
6. Cabell, M. J., *Analyst*, 1952, **77**, 859.
7. Drysen, D., and Dahlberg, V., *Acta Chem. Scand.*, 1953, **7**, 1186.
8. King, D. T., and Jackson, N., Atomic Energy Research Establishment Report CE/R 1876, Harwell.

Received May 28th, 1957

The Molybdate Method for the Determination of Phosphorus, Particularly in Basic Slag and in Steel

By D. STOCKDALE

(The University Chemical Laboratory, Cambridge)

The yellow precipitate of molybdophosphate obtained under controlled conditions has the empirical formula $(\text{NH}_4)_2\text{H}[\text{P}(\text{Mo}_3\text{O}_{10})_4]\cdot\text{H}_2\text{O}$, and it is transformed into the triammonium salt, $(\text{NH}_4)_3[\text{P}(\text{Mo}_3\text{O}_{10})_4]$, by washing it with a dilute solution of ammonium nitrate. Conditions for the complete removal of phosphoric acid from solution as the former salt have been delimited and the results have been applied to the determination of the phosphorus in basic slag and in steel.

When the precipitate is formed in the presence of substantial concentrations of sulphates or of ferric salts it is too heavy, and the method used to obtain a correct result is to dissolve the first precipitate in ammonia solution, to remove the molybdenum as molybdenum sulphide and to re-precipitate the phosphorus as molybdophosphate.

Volumetric methods, with and without the use of formaldehyde, have been examined. Some pH curves are given and the use of ammonium paramolybdate as a volumetric standard is described.

INVESTIGATION OF THE CONDITIONS FOR PRECIPITATING MOLYBDOPHOSPHATE

COMPOSITION OF THE PRECIPITATE—

There is some doubt about the composition of the salt obtained by adding a solution of ammonium molybdate to a solution of an orthophosphate containing large excesses of nitric acid and ammonium nitrate. The formula of the salt prepared under the conditions to be described later and after the precipitate had been washed with dilute nitric acid and dried at 140°C was $(\text{NH}_4)_2\text{H}[\text{P}(\text{Mo}_3\text{O}_{10})_4]\cdot\text{H}_2\text{O}$. It was found that 1877.5 g of precipitate (1 gram-formula-weight) were equivalent to 24 gram-equivalents of sodium hydroxide; the neutral solution required a further 2 gram-equivalents of sodium hydroxide after treatment with formaldehyde. In addition, the ammonia evolved on distilling the precipitate after treatment with sodium hydroxide was found, on collection in standard acid, to be equivalent to 34.8 g per gram-formula-weight (required by formula, 34.0 g); also, on heating the precipitate and passing the gases over copper oxide, the water collected in traps containing anhydrous calcium chloride was equivalent to 98.6 g per gram-formula-weight (required by formula, 99.1 g).

There are many reports in the literature that the precipitate as first prepared is the triammonium salt, with either one or two molecules of nitric acid in addition, *e.g.*, $(\text{NH}_4)_3[\text{P}(\text{Mo}_3\text{O}_{10})_4]\cdot\text{HNO}_3\cdot 2\text{H}_2\text{O}$. If the precipitates obtained in these experiments were originally of this composition, heating them to 140°C would entail the loss of ammonium nitrate. To get more information on this point, precipitates were prepared in the usual way and were kept at room temperature after they had been washed. One sample was dried in a desiccator over pellets of potassium hydroxide and another was air-dried on a porous plate, it being found later that there was no substantial difference between the two. As 1877 g of sample were found to be equivalent to 22.51 gram-equivalents of sodium hydroxide and to 24.48 gram-equivalents after the addition of formaldehyde, there would appear to be only two ammonium groups present. Other portions of the precipitates were dried at 140°C to constant weight and the above-mentioned equivalents were corrected to a "dry" basis, becoming 24.19 and 26.30, respectively. As the yellow precipitate is hygroscopic, these results are consistent with the view that the original material was the diammonium salt of the formula given above, but damp and contaminated by a small quantity of nitric acid. The pure compound appears to be $(\text{NH}_4)_2\text{H}[\text{P}(\text{Mo}_3\text{O}_{10})_4]\cdot\text{H}_2\text{O}$.

When washed with a dilute solution of ammonium nitrate, the diammonium salt passes easily into the triammonium salt, $(\text{NH}_4)_3[\text{P}(\text{Mo}_3\text{O}_{10})_4]$, with a decrease in the pH of the solution used for washing. It was found that 1876.5 g of precipitate (1 gram-formula-weight) were equivalent to 23 gram-equivalents of sodium hydroxide; the neutral solution required approximately a further 3 gram-equivalents of sodium hydroxide after treatment with formaldehyde.

Note that the molecular weights of these salts are so nearly the same that it is a matter of indifference in gravimetric analysis whether one or other or a mixture of the two is weighed. The gravimetric factors for the diammonium and triammonium salts are, respectively: for P_2O_5 , 0.016506 and 0.016515; for P_2O_5 , 0.03781 and 0.03783.

CONDITIONS FOR PRECIPITATION—

Stirring—Local supersaturation can persist for long periods in a stagnant solution even in the presence of the precipitate, no matter what the composition of the solution. Stirring, therefore, is essential if erratic results are to be avoided. When borderline conditions are being examined, the stirring must be done in some standard way, and in this work it was done with a stout glass rod by hand during the addition of the precipitant and thereafter for 1 minute every 15 minutes, four times in all during the hour allowed for precipitation.

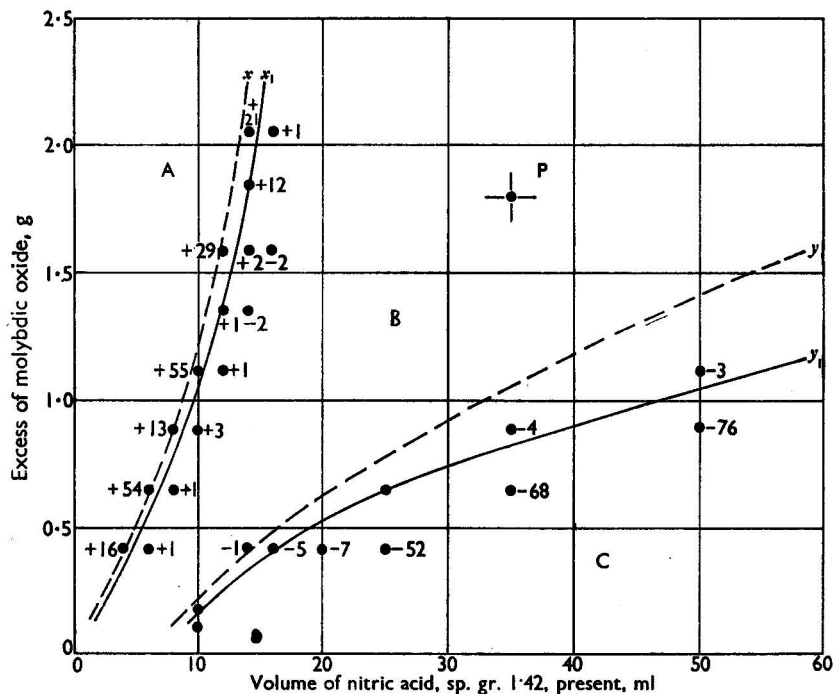

Fig. 1. Conditions for the precipitation of molybdophosphate in 250 ml of solution at 70° C: x and y , the boundaries between zones A and B and B and C, respectively, are for 12.5 g of ammonium nitrate in the solution; similarly x_1 and y_1 are for 25 g of ammonium nitrate in solution. Point P indicates the standard conditions under which the work described in the paper was carried out. The numerical values indicate the difference, in mg, between the calculated and determined weights of precipitate

Effect of molybdic oxide and nitric acid—Of the many factors that affect the formation of the precipitate, the excess of molybdic oxide used and the concentration of the nitric acid are the most important. These have been investigated, the precipitates being formed in 1 hour at 70° C from a final volume of 250 ml containing 25 g of ammonium nitrate, stirring being as described above. A weight of AnalaR potassium dihydrogen orthophosphate to give a precipitate of about 300 mg was taken and the solution was brought to 70° C and so adjusted that after the molybdate had been added the final volume was 250 ml with the concentration of the reagents as desired. The molybdic oxide was added as a solution of ammonium paramolybdate, in small part from a burette to make up the weight of molybdic oxide required, but the bulk, itself at 70° C, from a free-running pipette, this being the last adjustment to be made to the solution. The results are shown in Fig. 1, the numbers on the diagram being the "found less calculated" weights in mg and refer only to solutions containing 25 g of ammonium nitrate (full lines). With too little molybdic oxide and too much nitric acid, some phosphate remains in solution, but when the proportion of these reagents

is reversed, the precipitates are too heavy. For this condition there is a time effect: in many experiments the particles of yellow precipitate were coarse and settled out quickly, leaving a clear solution, which became turbid or threw down a white precipitate during the last few minutes of the hour. The position of the boundary between zones A and B, therefore, depends to some extent on the time allowed for precipitation and also, presumably, on the temperature. There is, however, a very wide range of conditions, zone B, under which precipitates of the correct weight can be obtained. These precipitates have been washed with untreated nitric acid, and all are therefore slightly light. The following concentrations have been standardised for much of the further work described in this paper: 1.8 g of molybdic oxide in excess, 35 ml of nitric acid, sp.gr. 1.42, and 25 g of ammonium nitrate in a final volume of 250 ml (point P in Fig. 1).

Effect of ammonium nitrate—The broken lines in Fig. 1 show the effect of reducing the concentration of ammonium nitrate from 25 to 12.5 g in 250 ml. This is unimportant except with high concentrations of nitric acid.

Effect of temperature—This was investigated by using potassium dihydrogen phosphate and the standard mixture, with a precipitation time of 1 hour. Results for precipitation between 30° and 70° C were satisfactory, but those at 80° C were about 2 per cent. too high. Clearly a temperature of 70° C is about the maximum at which the pure molybdophosphate can be obtained, and it was decided for greater certainty to adopt 60° C as the standard temperature for precipitation. This has proved satisfactory for basic slag and for other determinations of phosphorus, except in the presence of a large concentration of iron, as for phosphorus in steel. In this last analysis precipitates obtained at 60° C were too heavy, but those got at 40° C were of approximately the correct weight (see Table III, p. 32).

Attempts were made to throw down the precipitate at room temperature (15° C), by leaving the solutions overnight with clean air bubbling through them, but about 10 per cent. of the phosphate was not precipitated.

Washing the precipitate—If the yellow precipitate is washed with pure water, there is a serious risk of it breaking up and passing through the filter as very fine white particles. If the water contains a high enough concentration of some suitable electrolyte, this does not happen. Electrolytes often used are nitric acid, ammonium nitrate and potassium nitrate, the last only when the yellow precipitate is not to be weighed directly. In rare instances, 1 per cent. solutions have not prevented break-up, and the use of solutions of double this concentration is recommended. Losses during washing may be serious. With 2 per cent. ammonium nitrate, 350 mg of clean precipitate in a Gooch crucible lost about 1 mg per 100 ml of solution added at the rate of 10 ml per minute. With 2 per cent. nitric acid under the same conditions the losses were 15 to 20 mg. Somewhat crude attempts to measure the solubilities at room temperature were made, it being found that the solubility of the molybdophosphate in 2 per cent. ammonium nitrate was 55 mg per litre and somewhat more in a 5 per cent. solution. Two per cent. nitric acid reacts slowly with the precipitate, so that the true solubility in it was not found. The solubility after 24 hours was 250 mg per litre, but the solid had completely disappeared after a further 5 days, indicating a solubility greater than 400 mg per litre. The effect of potassium nitrate was examined only superficially, but it also seems to react with the precipitate, losses in the crucible being rather smaller than with nitric acid.

Clearly 2 per cent. ammonium nitrate is a suitable liquid for washing, provided care is taken not to over-wash. Its use, however, demands that in exact work the precipitates should be dried at 280° C to eliminate the ammonium nitrate. Acceptable results have been obtained by using 2 per cent. nitric acid that had been shaken with molybdophosphate, either specially made or old precipitates contaminated with asbestos, leaving the residues in the nitric acid overnight and filtering through No. 42 Whatman filter-paper before use. The beakers were cleaned with two 20-ml volumes of pure 2 per cent. acid and the crucibles were washed with five 10-ml volumes of the treated acid. The precipitates were dried at 140° C. This seems to be no more than a trick whereby the loss in weight of the precipitate through dissolution in the acid is made up by the weight of the solids that the treated acid leaves behind.

Accidental introduction of phosphorus—It must be remembered that in the determination of phosphorus relatively very large amounts of reagents are used. It follows that what appear to be quite insignificant traces of phosphorus in a reagent may have an important effect on a result. In accurate work, therefore, it is essential either to use a pure phosphate as

a control or to have reagents free from phosphorus. In this connection most samples of ammonium nitrate have been found to contain significant amounts of phosphate.

Precipitant—The precipitates have been produced by adding enough nitric acid and concentrated solution of ammonium nitrate to the phosphate solution to give the desired final concentration, and then by adding molybdic oxide as ammonium paramolybdate; a solution often used contained 50 g of the salt per litre to which small amounts of ammonia had been added as a stabiliser. A 50-ml portion of this solution contained 2 g of molybdic oxide, which will usually give the required excess in 250 ml.

A precipitant suitable for general use and free from phosphorus was prepared as described below under "Reagent."

METHOD FOR DETERMINING PHOSPHATE

REAGENT—

Ammonium molybdate reagent—Dissolve 250 g of ammonium nitrate in 250 ml of water in a flask and add 350 ml of nitric acid, sp.gr. 1.42. Dissolve 25 g of ammonium paramolybdate in 150 ml of water and slowly add this solution to the nitrate solution, shaking the flask well during the addition. Dilute to 1 litre and add 1 mg of potassium dihydrogen phosphate in solution. Put the flask into a water bath at 60° C and leave it there for 6 hours, shaking it occasionally. Allow the solution to cool with the bath overnight and filter it next day through a No. 42 Whatman filter-paper, without washing the filter-paper.

No precipitate formed in a sample of the reagent that was kept for 3 months.

PROCEDURE—

Dilute the approximately neutral solution, which should not contain more phosphate than will give a precipitate of 400 mg, to 150 ml. Raise its temperature to 60° C, preferably by using a water-bath with crude thermostatic control, and run into it 100 ml of ammonium molybdate reagent, itself at 60° C. Use a fast-flowing pipette and stir to mix the two solutions thoroughly. Maintain the temperature for 1 hour, well stirring the contents of the beaker from time to time. Collect the precipitate in a Gooch or sintered-glass crucible, using two 20-ml portions of 2 per cent. ammonium nitrate solution to transfer it from the beaker, and rubbing over the glass with a rubber-tipped glass rod. Wash the precipitate in the crucible with five 10-ml volumes of the ammonium nitrate solution. Dry the precipitate at 280° C.

RESULTS

For 12 determinations on potassium dihydrogen phosphate made in four groups by the procedure described above, on different days, the results were: found, 343.9 mg, with a standard deviation of ± 0.8 mg; required, 343.8 mg. With precipitates washed with nitric acid, for 16 determinations on 5 days: found, 343.8 ± 0.4 mg; required, 344.0 mg.

There is no reason for thinking that these precipitates are other than stoichiometric. Although there is an element of adjusting the technique to give the desired result when weighing as the diammonium salt, this is absent for the other salt, when the precipitates were washed until they were only just clean, the test being made by adding a small amount of ammonium chloride to the solution before filtration and looking for chloride in the washings.

The potassium dihydrogen phosphate used came from three sources. A sample from one of the sources was recrystallised from water and also from dilute hydrochloric acid. No difference between any of the five samples could be detected and therefore it seems probable that all were of high purity. The samples were dried at 110° C for 1 hour before use. Additional evidence about the purity of the phosphate is given on p. 29.

GRAVIMETRIC DETERMINATION OF TOTAL PHOSPHATE IN BASIC SLAG

• The slag analysed was a sample of Basic Slag A from the British Chemical Standards series, used in the "as received" condition. This slag had been examined by 16 analysts by a variety of methods. Their mean result was 12.92 per cent. of P_2O_5 . For gravimetric and volumetric molybdate procedures only (15 results), the median result was 12.88 per cent. and the mean 12.96 per cent., with a standard deviation of 0.21 per cent.

In the analysis of slag, the reagent used to get the phosphate into solution must not interfere in the precipitation of the molybdophosphate. It should be efficient in that no

further treatment of any insoluble residue should be necessary, and the solutions should be quick to filter. The efficiencies of hydrochloric, nitric, perchloric and sulphuric acids have been examined for these requirements, the usual methods for extraction being employed. At some stage, and more particularly during the final stages of washing, filtration was always slow, but from this point of view the treatments with hydrochloric and perchloric acid were of about equal efficiency and markedly superior to the others. All the acids left coloured residues containing phosphorus, which were got into solution by fusion with sodium bicarbonate after digestion with hydrofluoric acid. In this respect hydrochloric acid was the least efficient. It was found, with 2-g samples, that about 1 per cent. of the phosphate was retained in the residue after the treatment with hydrochloric acid, while the phosphate left behind by each of the other acids was about one-third of this. It would seem, therefore, that for the most accurate results the first residues cannot be neglected, no matter what the treatment, and that there is nothing to be gained by departing from the well tried preliminary opening with hydrochloric acid. In work of a less exact nature, perchloric acid might be used and the residues neglected.

The determinations were made on aliquot portions representing about 100 mg of slag and giving about 350 mg of molybdophosphate, at least two solutions of the phosphate prepared by each of the four methods being used. Either the diammonium or the triammonium salt was produced and the determinations were made with and without controls of pure potassium dihydrogen phosphate. As is to be expected in view of the results given earlier, the effect of controls on the final result was either very small or negligible. All the determinations were made in accordance with the procedure described on p. 27, and the results are shown in Table I.

TABLE I
ANALYSIS OF BASIC SLAG

Treatment	Number of determinations	Range of P_2O_5 content, %	Mean P_2O_5 content, %	Standard deviation, P_2O_5 per 100 parts of slag
Hydrochloric acid ..	8	12.63 to 12.73	12.68	± 0.036
Nitric acid ..	10	12.68 to 12.76	12.73	± 0.028
Perchloric acid ..	14	12.65 to 12.80	12.74	± 0.046
Sulphuric acid ..	6	13.28 to 13.79	13.49	± 0.18

From these results it is seen that, the anomalous result with sulphuric acid apart, the means do not seem to be significantly different and give a final result of 12.72 per cent. of P_2O_5 . This is about 1 in 50 lower than the stated P_2O_5 content.

INFLUENCE OF SULPHATE AND IRON—

Precipitates produced in the presence of substantial concentrations of sulphuric acid or of ferric salts are always heavier than expected, sometimes to the extent of 20 mg in 300 mg. The traces of sulphate or iron they contain are in no way sufficient to account for this increase in weight. It is thought that in the presence of these ions a precipitate of a molybdophosphate richer in molybdenum than the duodeca salt is formed in part. If this view is correct, it would seem that to determine the molybdenum in an impure precipitate is no way out of the difficulty. To substantiate this view, precipitates made from potassium dihydrogen phosphate were heated to 470° C and weighed as $P_2O_5 \cdot 24MoO_3$, it being expected that any occluded sulphate would be eliminated at this temperature. The results were as follows: required, 366.8 mg; found, in absence of sulphate, 366.1 mg; found, after precipitation from 250 ml containing 5 g of ammonium sulphate, 388.3 mg. In another experiment, precipitates were made with and without the addition of ammonium sulphate. The ratio of their mean weights was 1.052. These were then determined volumetrically, when the ratio of their sodium hydroxide values was found to be 1.048. The interfering substance must neutralise sodium hydroxide, and must, I think, be molybdenum trioxide.

INFLUENCE OF PERCHLORATE—

The general similarity between the sulphate and perchlorate ions gave rise to the expectation that the precipitates would be too heavy when thrown down in the presence of perchlorates. In one experiment, in which pure potassium dihydrogen phosphate and 18 g

per 250 ml of perchloric acid were used, the mean weight of the precipitates was 390.7 mg, the calculated weight being 383.0 mg, and the sodium hydroxide ratio was 1.024. The standard deviations were large, as with sulphate. The effect, therefore, exists, but it is unlikely to prove of importance in practical analysis, as the concentration of acid used in these experiments was many times that likely to be found in a solution from the extraction of a phosphate.

It also seemed that it might be possible to lose phosphoric acid by volatilisation when fuming with perchloric acid, as with sulphuric acid. Therefore, some potassium dihydrogen phosphate was fumed with 10 g of 60 per cent. perchloric acid, the operation being more prolonged than would have been necessary in the extraction of a slag. The first effect should have caused the weight of the precipitate to be rather high; this second effect would cause it to be low. In fact, about exactly the calculated weight was obtained. It would seem, therefore, that this second effect also exists, but again to an extent unlikely to prove of importance.

PURIFICATION OF THE PRECIPITATE—

Many unsuccessful attempts have been made to purify molybdophosphate precipitates by simple dissolution in an alkaline liquid followed by re-precipitation from a solution containing nitric acid. Stoichiometric precipitates made from potassium dihydrogen phosphate were almost invariably heavier after such treatment. The reason for this has not been found, but the only successful method of purifying precipitates that were heavy because they had been made in the presence of sulphate or iron was to remove the molybdenum and to make a fresh start with the solution of orthophosphoric acid (see p. 30).

THE MAGNESIUM PYROPHOSPHATE METHOD—

The purity of one of the samples of potassium dihydrogen phosphate after being dried, but without recrystallisation, was tested by the method of Schmitz,¹ the precipitates weighed being either magnesium pyrophosphate or magnesium ammonium phosphate. The salt appeared to be about 99.7 per cent. pure. This low result was accounted for in part by the dissolution of the magnesium ammonium phosphate during washing. No phosphate could be found in the solution from which the salt had been precipitated, but the later washings after concentration always gave a yellow precipitate by the molybdate test. The final result for the purity of the phosphate after correcting for this loss was 99.83 ± 0.10 per cent.

DETERMINATION OF PHOSPHORUS IN STEEL

As is well known, the molybdophosphate will not form quantitatively in a solution containing a high concentration of ferric ions unless the concentration of molybdic oxide is correspondingly increased. If, however, the standard conditions are modified in this way, the results are unsatisfactory, because the weight of precipitate obtained depends on the amount of precipitant used. This is shown in Fig. 2. The points X near the curve for the steel containing 0.076 per cent. of phosphorus refer to experiments in which the nitrate ion was replaced by the perchlorate ion—there is no improvement. There is, however, some improvement if the precipitate is formed at 40° C instead of at 60° C, and indeed it is possible to get reasonable results at the lower temperature by a single precipitation, followed by either gravimetric or volumetric analysis. Some representative results are given later.

The horizontal lines, x , in Fig. 2 represent the limiting conditions under which a quantitative result can be obtained with a solution of pure potassium dihydrogen phosphate, and show the marked retardation caused by iron. The vertical lines represent estimates of the weights of precipitate that should have been obtained from the steel used. It might be thought that it would be possible to devise a method in which only a limited excess of oxide is used, as shown by the intersection of these lines with the curves (about 2.4 g in Fig. 2), but attempts to do this gave unsatisfactory results. Under this condition the weight of precipitate obtained is sensitive to small changes in experimental detail, and the results lacked precision.

If the earlier findings of this paper are correct, namely that the increase in weight of the precipitate is due to excess of molybdenum oxide and that this cannot be removed by simple dissolution and reprecipitation and also that the molybdophosphates are suitable gravimetric compounds in that they are completely insoluble in the mother liquors and normally stoichiometric, it would seem reasonable to isolate the phosphate by using a large

excess of molybdic oxide to be quite certain of complete precipitation, to remove the molybdenum from this precipitate and to precipitate the phosphate anew as molybdophosphate from what would be essentially a solution of orthophosphoric acid free from interfering substances. A method on these lines is described below.

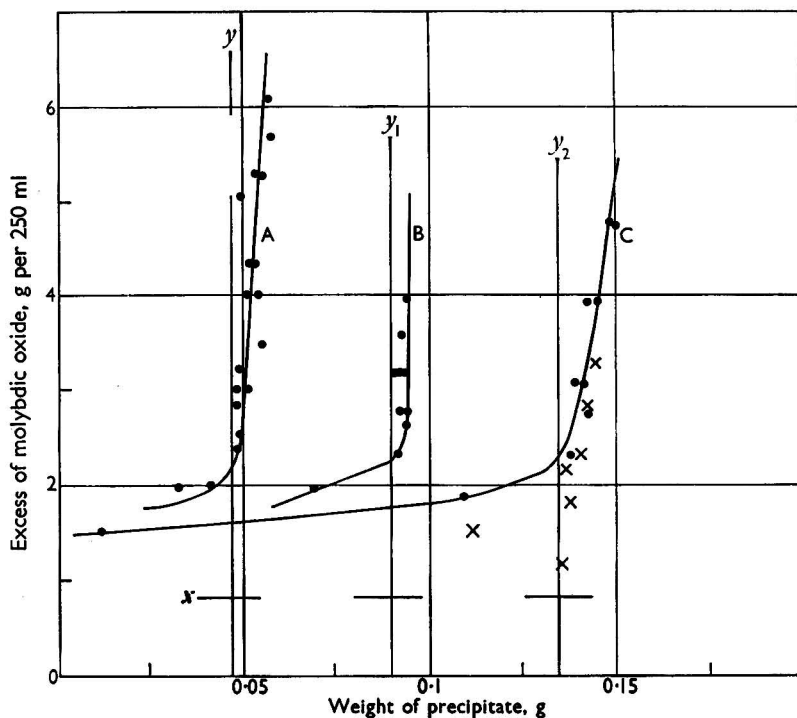

Fig. 2. Determination of phosphorus in various steels: curve A, 3 g of a steel containing 0.028 per cent. of phosphorus at 60° C; curve B, 2 g of a steel containing 0.076 per cent. of phosphorus at 40° C; curve C, 3 g of a steel containing 0.076 per cent. of phosphorus at 60° C. Points marked X represent an experiment in which nitrate ions were replaced by perchlorate ions. Ordinates y , y_1 and y_2 represent the theoretical weight of precipitate; the abscissa x represents the limiting conditions when potassium dihydrogen phosphate is used in place of the steel

MOLYBDENUM SULPHIDE METHOD

REAGENTS—

Concentrated ammonium molybdate reagent—A solution containing 40 g of ammonium molybdate, 250 g of ammonium nitrate and 250 ml of nitric acid, sp.gr. 1.42, per litre, made as described on p. 27. As this solution is slightly unstable, after a week or so a small deposit forms. The solution should be decanted from this before use.

Dilute ammonium molybdate reagent—A solution containing 20 g of ammonium molybdate, 200 g of ammonium nitrate and 250 ml of nitric acid, sp.gr. 1.42, per litre. There was no precipitate after the solution had been kept for 3 months.

PROCEDURE—

To 2 g of the steel and 40 ml of water in a covered 400-ml beaker add 20 ml of nitric acid, sp.gr. 1.42, in such a way that the reaction does not get out of control. (Note 1.) Gently boil the solution on a hot-plate until most of the nitrous fumes have been driven out. Add 2 ml of 2.5 per cent. w/v potassium permanganate solution, stir and continue to boil for 3 minutes. Dissolve the manganese dioxide by adding water saturated with sulphur dioxide drop by drop to the stirred solution (about 1.5 ml may be required) and continue the gentle boiling for 2 minutes longer. Dilute the solution to 150 ml with water, and heat it to 60° C. Add 100 ml of concentrated ammonium molybdate reagent, itself at 60° C, to the

stirred solutions, delivering from a free-running pipette. Stir the contents of the beaker from time to time and filter through a 9-cm Whatman No. 40 filter-paper after 1 hour. Rinse the beaker twice with 2 per cent. ammonium nitrate solution at room temperature, using 20-ml portions. Wash the paper four times with 10-ml portions of this solution. Discard the filtrate.

Drip 5 ml of diluted ammonia solution (1 + 2) on to the paper and collect the filtrate in the original beaker. Cover the funnel with a clock-glass. When all traces of the yellow precipitate have disappeared, wash the paper with six 10-ml portions of near-boiling water. Bring the volume of the filtrate to 100 ml and pass in hydrogen sulphide until there is no further change of colour. Dilute 10 ml of diluted hydrochloric acid (1 + 1) to 50 ml in a 400-ml beaker. Pour the acid into the sulphide solution and raise the temperature nearly to the boiling-point. Filter the solution through a 9-cm Whatman No. 40 filter-paper, collecting the filtrate in the beaker used for the hydrochloric acid. Wash the beaker with three 20-ml portions of near-boiling 1 per cent. hydrochloric acid, using a rubber-tipped glass rod to remove the last traces of precipitate, and then wash the precipitate on the paper seven times with the hot acid (see Note 2).

Reduce the volume to about 30 ml by evaporation. Dissolve any precipitate by adding nitric acid drop by drop, and then increase the pH by adding diluted ammonia solution (1 + 2) until methyl orange just turns yellow. Bring the volume to 50 ml and the temperature to 60° C. Add 50 ml of dilute ammonium molybdate reagent, itself at 60° C, and continue the precipitation as before. Collect the precipitate in a Gooch or sintered-glass crucible, washing it as before, but using five portions of the ammonium nitrate when washing it in the crucible. The use of a rubber-tipped glass rod is essential. Dry the precipitate at 280° C.

NOTES—

1. As about 5 ml of nitric acid are used per g of steel, about 10 ml of nitric acid will be left.
2. As phosphate may be retained by the molybdenum sulphide, the precipitate must be washed thoroughly, and the correctness of the washing technique used should be checked from time to time by dissolving the molybdenum sulphide and testing for phosphate in the solution. Almost certainly some molybdenum sulphide will pass into solution during the washing and will appear as a brown scum when the filtrate is evaporated. This scum is dissolved by nitric acid and the presence of this molybdenum does not affect the final result.

METHOD FOR DETERMINATION BY A SINGLE PRECIPITATION

Prepare the solution of 2 g of steel as described above under the molybdenum sulphide method. Bring the volume to 150 ml and the temperature to 40° C. Add 100 ml of concentrated ammonium molybdate reagent, itself at 40° C and refiltered if necessary. Stir the solution from time to time. After 1 hour, collect, wash, dry and weigh the precipitate, as described above for the molybdenum sulphide method.

THE ANALYSIS OF STEELS

These methods have been tested against the British Standard method² and against controls made by adding potassium dihydrogen phosphate to a solution of high-purity iron. In the British Standard method the phosphorus is precipitated as molybdophosphate after the removal of silicon by baking and of arsenic by means of bromine. The phosphate is then converted into lead molybdate and is weighed as such. The iron used was A.H.R.4, supplied by the courtesy of the British Iron and Steel Research Association and declared to contain less than 0.001 per cent. of phosphorus. Somewhat uncertainly, by a difficult analysis, it was found to contain 8 p.p.m. of phosphorus.

The steels analysed were from the British Chemical Standards series. They were B.C.S. Nos. 240, 232 and 152 and were declared to contain about 0.028, 0.076 and 0.083 per cent. of phosphorus, respectively. There was nothing unusual about their content of other elements, except that No. 152 contained 0.24 per cent. of sulphur and 0.015 per cent. of arsenic. The steels had been analysed by groups of independent analysts by the British Standard method for the most part, except for No. 152, an older standard, for which a direct molybdate procedure had been used.

Usually at least four determinations were made for each steel by each method (see last column of Table III). These were made in groups, each group consisting of two samples of a steel and two controls containing a similar weight of phosphorus made by adding known weights of potassium dihydrogen phosphate to high-purity iron. The phosphate was added to the control at the earliest possible stage and the two pairs were treated as nearly as possible in the same way. It was expected that day-to-day variations in technique would cause all the results of a group of four to have errors of the same sign. It was found, however, that the errors were nearly random and that the final results would have been almost the same had the controls and the steels been treated apart. The results were in small groups and the standard deviation for each was calculated. If the deviation for a result was more than twice the standard deviation, that result was rejected on the ground that a "wild" result might have been caused by an abnormal error: in any event its inclusion in such a small population would no doubt have an undue effect. Of 94 determinations in 15 groups, five, of which four were for steels by the British Standard method, were rejected in this way.

The results for the controls are given in Table II.

TABLE II

DETERMINATION OF PHOSPHORUS IN STEEL: RESULTS OF CONTROLS

Method	Phosphorus found (F), %	Phosphorus sought (S), %	F-S, p.p.m.	Number of determinations
British Standard	0.0340	0.0308	+32	6
Molybdenum sulphide	0.0319	0.0308	+11	6
Single precipitation	0.0320	0.0308	+12	4
British Standard	0.0759	0.0757	+ 2	11
Molybdenum sulphide	0.0764	0.0757	+ 7	10
Single precipitation	0.0768	0.0757	+11	8

Points to note in Table II are the exceptionally high value got for low-phosphorus steels by the British Standard method and that the "found" values are always high. It may be that all the methods have a bias in the high direction, but it is more probable that phosphorus has been accidentally introduced, because the differences do not depend on the amount of phosphorus sought. The appearance of 0.02 mg of phosphorus from the reagents or elsewhere would account for this discrepancy.

The results for the steels are given in Table III. The found-less-calculated values were obtained for the controls and were applied to the absolute results got for the steels. The results after adjustment in this way are given in the fourth column of the Table.

TABLE III

DETERMINATION OF PHOSPHORUS IN STEEL

Steel	Method	Absolute result, % of P	Controlled result, % of P	Number of determinations
B.C.S. No. 240	British Standard	0.0296	0.0268	4
	Molybdenum sulphide	0.0270	0.0261	4
	Single precipitation	0.0273	0.0263	6
	B.C.S. value	0.0280		
B.C.S. No. 232	British Standard	0.0749	0.0746	5
	Molybdenum sulphide	0.0741	0.0739	8
	Single precipitation	0.0753	0.0742	4
	B.C.S. value	0.0760		
B.C.S. No. 152	British Standard	0.0814	0.0808	9
	Molybdenum sulphide	0.0794	0.0785	4
	Single precipitation	0.0806	0.0796	4
	B.C.S. value	0.0830		

In an attempt to obtain some idea of the precisions of the three methods, the results for the low-phosphorus controls and steel were collected together to give reasonably large groups, and so also for the high-phosphorus determinations. The grouped standard deviations are shown in Table IV. There is some indication that the British Standard method is the least precise, at least for steels containing substantial quantities of phosphorus.

The results given in the Tables have been examined statistically at some length, but little has emerged. It seems probable that there is no significant difference between any of the controlled mean results got by the three methods, except that the molybdenum sulphide method may have given a lower result for B.C.S. No. 152. This is the steel that contains 0.015 per cent. of arsenic, and it may be that the sulphide method eliminates arsenic or some other interfering element more thoroughly than do the other methods. The interference, if any, is very small, and is equivalent to about 1 part per hundred thousand of phosphorus. The method of additions showed that small quantities of chromium, silicon, titanium and vanadium do not interfere in the molybdenum sulphide method.

TABLE IV

DETERMINATION OF PHOSPHORUS IN STEEL: PRECISION OF RESULTS

Method	(a)		(b)	
	Standard deviations for low-phosphorus results, p.p.m.	Standard deviations for high-phosphorus results, p.p.m.	Standard deviations for low-phosphorus results, p.p.m.	Standard deviations for high-phosphorus results, p.p.m.
British Standard ..	±5 (10)	±10 (25)	±16 (11)	±17 (28)
Molybdenum sulphide ..	±2 (10)	± 5 (22)	± 2 (10)	± 6 (23)
Single precipitation ..	±7 (10)	± 4 (16)	± 7 (10)	± 4 (16)

Columns (a) refer to results after the rejection of five determinations (see p. 32); columns (b) refer to all results. The numbers of determinations are shown in brackets.

COMMENTS ON THE BRITISH STANDARD METHOD—

In this method the use of a rather greater concentration of molybdic oxide in the initial precipitation of the molybdophosphate than is employed here is recommended. I should, therefore, expect the results given by the method to be rather high. Co-precipitation of lead orthophosphate with the lead molybdate might also cause the results to be high. On the other hand, they might well be low, because the specification does not insist on vigorous and repeated stirring, but says only "shake the solution until the precipitate forms and allow to stand on the bench for 20 min." These effects might quite well lead to a correct final result, but a rather large deviation is perhaps to be expected.

Collected precipitates of lead molybdate have been examined from time to time and phosphate has always been found in them, but only to a trifling extent. My estimate is that the co-precipitation of phosphate causes the final result to be high by 1 in 200.

Phosphate, however, has been found in the washings in important amount. Table V shows results got by working with low and high phosphorus controls and with two of the steels. In these experiments the specification for the precipitation as molybdophosphate was followed as closely as possible. The mother liquor was then diluted and the phosphate in it was precipitated as suggested earlier in this paper, 1 hour being allowed for the salt to form. The final weighing was as lead molybdate. Each experimental result in the Table is the mean of four determinations that differed rather widely among themselves.

TABLE V

PHOSPHORUS IN RESIDUES BY THE BRITISH STANDARD METHOD

2-g samples of steel were taken in each experiment

	Lead molybdate in main precipitate, g	Lead molybdate in residue, g	Total lead molybdate, g	Lead molybdate sought, g
Low-phosphorus control	0.0964	0.0075	0.1039	0.0876
B.C.S. steel No. 240 ..	0.0835	0.0069	0.0904	—
High-phosphorus control	0.2170	0.0152	0.2322	0.2153
B.C.S. Steel No. 152 ..	0.2289	0.0153	0.2442	—

The calculated weights for the steels are 0.075 g of lead molybdate for B.C.S. No. 240 at 0.026 per cent. of phosphorus and 0.225 g of lead molybdate for B.C.S. No. 152 at 0.079 per cent. of phosphorus. These results confirm those of Table III, namely that without controls

high results were got for the steel low in phosphorus and that those for the other were nearly correct. There is always, however, an important fraction of the phosphorus left in solution. There must be compensating errors, and hence the experimental conditions must be varied as little as possible if a high precision is to be obtained. It will be seen from Table V that, if a control is applied at either stage, the effect will be to give approximately correct results for both steels.

It is suggested that the reason for the relatively large precipitates got for the low-phosphorus steel is that when the phosphorus content is low, the precipitate is somewhat slow to form, its grain size is small and it settles slowly, so leading to less supersaturation.

CONCLUSIONS—

It should be noted that, although the results got for the controls were either nearly correct or slightly high, the percentages of phosphorus both in the slag and in the steel as now determined are definitely lower than the accepted values, by about 1 in 50 for the slag and by about 0.002 per cent. for the steel.

VOLUMETRIC FINISH FOR DETERMINING PHOSPHATE

Possibly the volumetric methods for the determination of phosphorus that are now most used are based on the method of Pemberton.^{3,4} Pemberton washed his precipitates with water, dissolved them in standard potassium hydroxide and titrated the excess of hydroxide with nitric acid, with phenolphthalein as indicator. He standardised his acid against sodium carbonate. He stated that his precipitates were the triammonium salt and that 23 gram-equivalents of base were equivalent to 1 gram-atom of phosphorus.

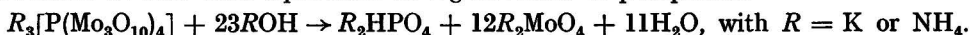

Pemberton's method was followed in general outline in the present work. After the gravimetric analysis, dry precipitates of known weight were dissolved in an excess of sodium hydroxide that had been standardised against AnalaR potassium hydrogen phthalate, and the excess was titrated with hydrochloric acid, with phenolphthalein as indicator. It was found advantageous to have some of the hydroxide in a second burette, to overshoot the titration with the acid and to finish with the solution a very faint pink, at a pH of about 8.

There have been many suggestions that better results are to be obtained by the elimination of the ammonia before the completion of the titration. This can be done either by heating the precipitate to about 450°C by boiling the solution in sodium hydroxide, or through the use of formaldehyde. The last of these methods is the most convenient and it has been tested extensively.

In addition to the Pemberton equation, the relevant equations are—

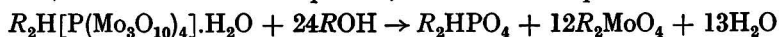

It was found for the diammonium salt that without and with formaldehyde 1 gram-formula-weight was equivalent, respectively, to 23.96 ± 0.16 and 25.98 ± 0.13 gram-equivalents of sodium hydroxide, and similarly for the triammonium to 23.02 ± 0.07 and 25.73 ± 0.09 gram-equivalents of sodium hydroxide. The number of titrations in each group was about 20, about 350 mg of precipitate being used for each titration, with approximately 0.25 *M* hydrochloric acid and sodium hydroxide. The deviations given are the standard deviations. Reasons for the low result for the triammonium salt after the elimination of the ammonia, and for the greater precision of the work with this salt, have not been found.

In routine analysis it will usually be undesirable to eliminate by heat a reagent used in washing and therefore the work on the diammonium salt is of academic interest only. If, however, the precipitate is collected on a pad in a filter crucible and washed with a dilute solution of ammonium nitrate, in accordance with the technique described on p. 27, with a single final wash with 20 ml of absolute ethanol, and dissolved straightway in sodium hydroxide, good results can be obtained relatively quickly. For precipitates made from a solution of potassium dihydrogen phosphate, and collected on asbestos pads, after the removal of the ammonia with formaldehyde the results were as follows: required, 18.81 ml of the standard hydroxide; found, after correction, 18.87 ± 0.03 ml. The correction for the nitrate retained by the pad was only 0.03 ml of 0.25 *M* hydroxide. The conclusion is that in general outline the method of Pemberton is quite satisfactory, and entirely so if the acid

and alkali are standardised against precipitates made from pure potassium dihydrogen phosphate. If, however, the precipitates are washed with water, as advised by Pemberton, there is serious risk that they will break up and pass through the filter. Phenolphthalein is satisfactory as indicator, and there is little to be gained, and indeed there may sometimes be a small loss of accuracy, through the use of formaldehyde.

The commoner practice is to wash the precipitate with a solution of potassium nitrate instead of ammonium nitrate. The potassium ions replace the protons as before and a neutral molybdophosphate is obtained. This method has not been examined in detail, but it seems to be satisfactory even though the yellow precipitate is substantially more soluble in the 2 per cent. potassium salt than it is in 2 per cent. ammonium nitrate, as an examination of the used washing solutions will show. The cationic exchange, however, does not stop with the replacement of the protons, but one of the ammonium groups is replaced also to give $(\text{NH}_4)\text{K}_2[\text{P}(\text{Mo}_3\text{O}_{10})_4]$. This exchange, which takes place fairly easily, has little effect on the result of an ordinary titration, but 24 gram-equivalents, somewhat indefinitely, of sodium hydroxide are required per gram-atom of phosphorus if formaldehyde is used. If this salt is kept under a dilute solution of potassium nitrate, the solid remains of constant composition, but it dissolves slowly and it may be that there is further slow displacement to give a soluble salt.

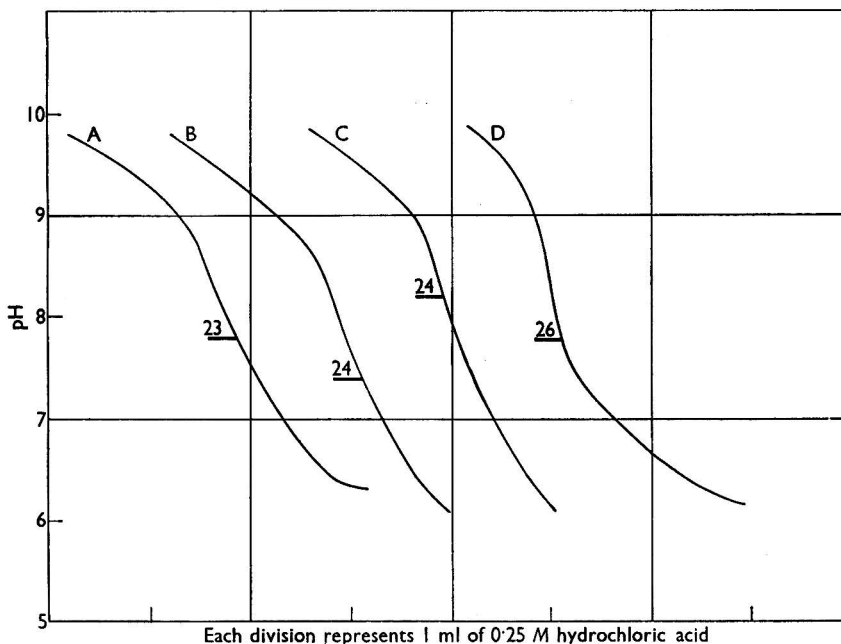

Fig. 3. Titration of unused 0.25 *M* sodium hydroxide after addition of: curve A, $(\text{NH}_4)_3[\text{P}(\text{Mo}_3\text{O}_{10})_4]$; curve B, "synthetic" $(\text{NH}_4)_2\text{H}[\text{P}(\text{Mo}_3\text{O}_{10})_4]$; curve C, $(\text{NH}_4)_2\text{H}[\text{P}(\text{Mo}_3\text{O}_{10})_4]\cdot\text{H}_2\text{O}$; curve D, $(\text{NH}_4)_2\text{H}[\text{P}(\text{Mo}_3\text{O}_{10})_4]\cdot\text{H}_2\text{O}$, after treatment with formaldehyde. The theoretical end-points are shown on each curve

Some of the pH curves plotted during this work are reproduced in Fig. 3; a Cambridge pH meter was used. Usually about 350 mg of the salt were dissolved in 25 ml of 0.25 *M* sodium hydroxide and the solution was then titrated with 0.25 *M* hydrochloric acid, so that 1 ml of acid represents about 1.4 gram-equivalents per gram-formula-weight. The calculated end-points, on the basis of the equations, are shown on the curves. An indicator that changes near pH 8.0 is suitable, and phenolphthalein would seem to be the best in view of the ease with which the first appearance of red can be seen. As none of the curves for the ammonium salts shows an abrupt change of slope, it is somewhat surprising that the precision to be obtained in an ordinary titration is as great as it is. The destruction of the ammonia with formaldehyde approximately doubles the rate of change of the pH near the end-point for the triammonium salt, but the greater complication introduced by the use

of this reagent counter-balances this advantage and does not lead to an increase in precision. The curve for the "synthetic" diammonium salt was obtained by dissolving suitable weights of diammonium hydrogen phosphate and molybdic oxide in 25 ml of standard sodium hydroxide, and the similarity of curves B and C, Fig. 3, is further proof of the formula $(\text{NH}_4)_2\text{H}[\text{P}(\text{Mo}_7\text{O}_{24})_4]$.

Although the Pemberton method is so satisfactory that an attempt to improve on it is perhaps redundant, the matter has been pursued further by introducing ammonium paramolybdate, $(\text{NH}_4)_6(\text{Mo}_7\text{O}_{24})_4 \cdot 4\text{H}_2\text{O}$, as an analytical standard. Such samples of the AnalaR grade of this salt as I have handled have been without exception of very high purity, and a preliminary check of the purity can be made by heating the salt to 300°C . Most samples then lose a trifle more weight than the theoretical and acquire a slight bluish tinge. The weight is regained and the blue tinge lost on moistening with nitric acid and reheating. Two 6-g samples lost 1.1079 and 1.1081 g (required, 1.1083 g). Had a sample contained 1 part per thousand of non-volatile impurity the loss in weight would have been 1.1072 g. The powdered salt is stable when kept in a desiccator with technical calcium chloride. As the end-point with phenolphthalein is very poor when the salt is titrated with sodium hydroxide, the removal of the ammonia with formaldehyde is essential. Portions of the paramolybdate and the yellow precipitate are dissolved separately in an excess of sodium hydroxide and neutral formaldehyde is added; the solutions are titrated with hydrochloric acid after 15 minutes, with slight over-shooting, and the end-point is reached by adding a few drops of hydroxide. As titrations can be carried out in exact parallel, uncertainties about the complete destruction of the ammonia are partly eliminated. In these experiments the spent solutions were kept and the end-points were again determined after 3 hours and again next day, the additional sodium hydroxide required after 3 hours being 0.2 or 0.3 ml in 50 ml, and 0.05 ml next day. The results obtained after 3 hours were slightly better than those obtained after 15 minutes, but nothing was gained by putting aside the flasks for a longer time. When about 350 mg of weighed, heated diammonium molybdophosphate and 500 mg of paramolybdate were used, the ratios by volume of 0.25 M sodium hydroxide for equal weights of the salts were 1.226 ± 0.004 after 15 minutes and 1.223 ± 0.004 after 3 hours (required, 1.223). Starting from potassium dihydrogen phosphate without intermediate weighing, the ratio of volumes for 0.1 g of phosphate to 1 g of paramolybdate were 1.689 ± 0.003 and 1.686 ± 0.004 , respectively (required, 1.686). The results after 3 hours are slightly more accurate and rather more precise than those obtained by using sodium hydroxide standardised against potassium hydrogen phthalate.

Guidance in the statistical analysis was given by the late Mr. J. Wishart. I thank the British Iron and Steel Research Association for the gift of the high-purity iron.

REFERENCES

1. Schmitz, B., *Z. anal. Chem.*, 1924, **65**, 46.
2. British Standard 1121 : Part I : 1943.
3. Pemberton, H., *J. Amer. Chem. Soc.*, 1893, **15**, 382.
4. —, *Ibid.*, 1894, **16**, 278.

Received June 8th, 1956

Determination of the Major Constituents of Small Amounts of Tissue

(H.E.R.T. Tissue Culture Laboratory, Department of Biochemistry, The University, Glasgow, W.2)

By JOHN PAUL

A fractionation procedure that permits the determination of lipid, carbohydrate, protein nitrogen, ribonucleic acid and deoxyribonucleic acid in single samples of tissue of about 1 mg dry weight is described. Lipids are extracted with organic solvents and determined by oxidation with chromic acid. Acid-soluble substances are extracted with cold *N* sulphuric acid and carbohydrate is determined in this extract by the anthrone method. Nucleic acids are extracted, together with the remaining carbohydrate, with hot *N* perchloric acid. The carbohydrate is determined by the anthrone method and the nucleic acids are determined by ultra-violet absorption. Deoxyribonucleic acid is determined by reaction with indole and ribonucleic acid is found by difference. Protein nitrogen is determined in the residue. The method is straightforward and reliable.

In previous studies the fractionation procedure of Schmidt and Thannhauser¹ has been applied to small amounts of tissue, such as tissue cultures, for the determination of ribonucleic acid and deoxyribonucleic acid.² Other components of tissue have been determined,^{3,4} but this has usually involved the analysis of replicate specimens, owing to the very small amounts of material available in tissue culture studies, and the necessity to prepare the samples for analysis in different ways. The method to be described, which is applicable to a very wide variety of tissues, was evolved to overcome this difficulty. It is based on Schneider's procedure⁵ for the determination of nucleic acids.

EXPERIMENTAL

Before fractionation is commenced, it is necessary to remove any medium or serum adhering to the tissue without removing cell constituents. It was found that this could be done by washing the tissue rapidly with a physiological salt solution while the cells were still alive.

DETERMINATION OF LIPID—

A modification of Bloor's method⁶ for determining total lipid by the colorimetric determination of the lipid-soluble material that can be oxidised by chromic acid was used, the intensity of the coloured solution being measured at 620 m μ . It was found that prior extraction of the tissue with the usual acids interfered with the reaction, since trichloroacetic acid appeared in the solvents and perchloric acid caused oxidation of the lipid material on evaporation of the solvents. By performing the extraction with fat solvents first, as in Ogur and Rosen's procedure,⁷ these difficulties were avoided. An ethanol-ether mixture was used as the first solvent in order to minimise the risk of extracting protein. A carbon tetrachloride-ether mixture was used as the second solvent, as the more usual chloroform interfered in the colorimetric reaction. Subsequent extraction of the lipid solvents with 1 per cent. sodium hydrogen carbonate solution gave slightly lower results for lipid material, presumably owing to the removal of small acid radicles. The mean of six determinations of lipid in embryonic chick liver by Bloor's method without extraction with 1 per cent. sodium hydrogen carbonate was 685 μ g, with a standard deviation of ± 15 μ g, and the mean of six determinations after extraction with 1 per cent. sodium hydrogen carbonate was 642 μ g, with a standard deviation of ± 15 μ g.

DETERMINATION OF NUCLEIC ACIDS—

The procedure of Ceriotti⁸ was modified. Excellent results were obtained for some tissues by the original fractionation, but it was found that with others, especially embryonic chick tissues, a constant loss of ribonucleic acid occurred during treatment with cold perchloric acid. It was observed that pure solutions of ribonucleic acid were much more stable to treatment with trichloroacetic acid or sulphuric acid than they were to perchloric acid and, when lipid extraction of the tissue was performed as the first stage, *N* sulphuric acid

could be used successfully to remove acid-soluble material. Thereafter, measurement of the ultra-violet absorption and determination of the deoxyribonucleic acid by the indole method⁹ in a warm perchloric acid extract, as described by Ceriotti,⁸ gave results for ribonucleic acid and deoxyribonucleic acid in good agreement with those obtained by the Schmidt and Thannhauser procedure (see Table I). Trichloroacetic acid was not used for the extraction of the acid-soluble substances, since its ultra-violet absorption interfered with the subsequent determination of nucleic acids.

TABLE I

COMPARISON OF AMOUNTS OF RIBONUCLEIC ACID AND DEOXYRIBONUCLEIC ACID DETERMINED BY THE SCHMIDT AND THANNHAUSER PROCEDURE AND BY THE PROPOSED FRACTIONATION SCHEME

Determinations were performed on at least six aliquots of each tissue

	Schmidt and Thannhauser method			Proposed scheme		
	Ribonucleic acid phosphorus (X), μg	Deoxyribo-nucleic acid phosphorus (Y), μg	Ratio of X to Y	Ribonucleic acid phosphorus (X), μg	Deoxyribo-nucleic acid phosphorus (Y), μg	Ratio of X to Y
Ehrlich mouse ascites tumour	80.5 ± 3.03	42.2 ± 0.354	1.91	82.5 ± 1.36	43.9 ± 0.171	1.88
Mouse liver (ascitic) ..	67.7 ± 5.36	15.85 ± 0.771	4.26	64.9 ± 1.19	17.6 ± 0.165	3.69
Embryonic chick liver ..	62.4 ± 1.76	22.3 ± 1.04	2.80	62.4 ± 2.36	23.15 ± 1.26	2.69

DETERMINATION OF CARBOHYDRATES—

The anthrone method, as described by Trevelyan and Harrison,⁹ was found to be satisfactory without modification.

DETERMINATION OF PROTEIN NITROGEN—

It was expected that protein nitrogen could be determined in the residue after the fractionation procedure had been completed, since, as shown by the following results, there was no loss of protein nitrogen at any stage during this procedure. The results for protein nitrogen in aliquots of horse serum determined in the residue after (a) extraction with lipid solvents, (b) extraction with lipid solvents and three extractions with cold *N* sulphuric acid and (c) extraction with lipid solvents, three extractions with cold *N* sulphuric acid and two extractions of 30 minutes each with *N* perchloric acid at 70° C were $1200 \pm 22 \mu\text{g}$, $1236 \pm 53 \mu\text{g}$ and $1200 \pm 45 \mu\text{g}$, respectively.

However, in some tissues a considerable deficit was found between the protein nitrogen determined in this way and the total nitrogen that could be precipitated by trichloroacetic acid. In order to exclude the possibility that protein nitrogen might be lost by hydrolysis in the warm perchloric acid, the distribution of nitrogen in the different fractions was investigated (see Table II). Although a considerable amount of nitrogen was found in all fractions, the amount found in the perchloric acid fraction was not more than could be accounted for by nucleic acids, which indicates that hydrolysis of protein at this stage is probably negligible.

TABLE II

DISTRIBUTION OF NITROGEN IN EHRlich MOUSE ASCITES TISSUE

Material tested	Nitrogen found, μg	Part of total nitrogen, %
Lipid fraction	337	12.15
Sulphuric acid fraction	225	8.11
Perchloric acid fraction	150	5.41
Trichloroacetic acid wash	12	0.43
Residual fraction	2050	73.9

If perchloric acid is not removed before protein is digested, the results for nitrogen may be low, owing to decomposition of ammonium perchlorate⁷ and therefore a single wash with trichloroacetic acid was introduced before carrying out the digestion.

METHOD

REAGENTS—

All reagents should be of recognised analytical grade.

Balanced salt solution—Prepared by dissolving 80 g of sodium chloride, 4 g of potassium chloride, 1.4 g of calcium chloride and 2 g of magnesium sulphate, $\text{MgSO}_4 \cdot 7\text{H}_2\text{O}$, in 1 litre of distilled water. For use, dilute the solution 1 + 9 with distilled water. The solution must not contain glucose or phosphate.

Ethanol - ether mixture (3 + 1 v/v).

Ether - carbon tetrachloride mixture (3 + 1 v/v).

Sulphuric acid, N and 10 N.

Perchloric acid, N and 4 N.

Trichloroacetic acid, N.

Sodium hydrogen carbonate solution, 1 per cent. w/v.

Ammonium molybdate solution, 2.5 per cent.

Aminonaphtholsulphonic acid reagent—Prepared by dissolving 1 g of 1-amino-2-naphthol-4-sulphonic acid, 59.5 g of sodium bisulphite and 2 g of anhydrous sodium sulphite in 1 litre of distilled water.

Chromic acid—Prepared by dissolving 12.5 g of silver dichromate in 500 ml of concentrated sulphuric acid. (As a precipitate may be formed when analytical-reagent grade sulphuric acid is used, it may be necessary to use the ordinary grade.)

Anthrone solution—Prepared by dissolving 200 mg of anthrone in 100 ml of 25 N sulphuric acid.

Indole solution, 0.04 per cent.

Chloroform.

Selenium dioxide solution—A solution containing 1 per cent. of selenium dioxide in 50 per cent. v/v sulphuric acid.

Nessler reagent (modified)—Prepared by adding a solution of 3.5 g of gum acacia in 750 ml of water to a solution of 4 g of potassium iodide and 4 g of mercuric iodide in 25 ml of water and adjusting the volume to 1 litre.

FRACTIONATION PROCEDURE—

The tissue is collected in a centrifuge tube and, after it has been spun in a centrifuge, the medium is discarded. Then 2 ml of the balanced salt solution are added and the tissue is stirred with a platinum wire and quickly spun in a centrifuge, the supernatant liquid being discarded. A 2-ml portion of ethanol - ether mixture is added and the resulting mixture is shaken and then set aside for 15 to 20 minutes at room temperature; it is then spun in a centrifuge and the supernatant liquid is collected. This procedure is repeated, first with 2 ml of the ether - carbon tetrachloride mixture and then with a further 2 ml of the ethanol - ether mixture, the supernatant liquid from each being combined to form the *lipid fraction*.

To the residue in the centrifuge tube are added 2 ml of ice-cold N sulphuric acid. The contents of the tube are mixed and left at 0° C for 10 minutes, with occasional stirring, and then spun in a refrigerated centrifuge, the supernatant liquid being collected. This procedure is repeated twice, the supernatant liquid from each being combined to form the *sulphuric acid fraction*.

A 2-ml portion of N perchloric acid is added to the material remaining in the tube and the contents are stirred as before. The tube is then immersed in a water bath at 70° C and left for 20 minutes. During this period the contents are stirred occasionally. The tissue is again separated by centrifugation and the supernatant liquid is collected. This procedure is repeated once, the supernatant liquid from each being combined to form the *perchloric acid fraction*.

The residue in the centrifuge tube is washed once with 2 ml of N trichloroacetic acid and the washing is discarded. The *residual fraction* remains.

PROCEDURE FOR THE LIPID FRACTION—

The lipid fraction is shaken with 2 ml of 1 per cent. w/v sodium hydrogen carbonate solution and, in order to facilitate the separation of the phases, 2 ml of ether may be added. When the layers have been separated, the sodium hydrogen carbonate layer is washed twice with 2 ml of ether each time and these washings are added to the ethanol - ether - carbon tetrachloride layer. This layer is then adjusted to a measured volume and aliquots are taken

for total lipid, lipid phosphorus or other determinations. The aliquots, preferably in short wide tubes, are evaporated to dryness in a hot-air bath and the lipid phosphorus and total lipid are determined as follows.

Lipid phosphorus—To the dry residue are added 0.5 ml of 10 *N* sulphuric acid and 0.5 ml of 4 *N* perchloric acid. This digestion mixture is concentrated by evaporation on a sand-bath at 160° C and digestion is completed over an open flame. It is necessary to add an anti-bump rod, made by indenting the end of a 6-inch length of $\frac{1}{8}$ -inch diameter glass rod with a copper wire. The phosphorus is then determined by the method of Griswold, Humoller and McIntyre.¹⁰

To the digested sample is added 0.5 ml of 2.5 per cent. ammonium molybdate solution and 0.5 ml of aminonaphtholsulphonic acid reagent and the volume is adjusted to 5 ml with water. After the mixture has been heated for 10 minutes in a boiling-water bath, the blue colour is measured in a suitable spectrophotometer (a Unicam SP600 was used) at 820 *mμ* or with a red filter. This method gives very accurate results in the range 0.2 to 2 μg of phosphorus. Note that the final concentration of acid in the reagents must not be less than *N*, otherwise artificially high results will be obtained.

Total lipid (Bloor's method⁶)—To the sample to be analysed are added 3 ml of the silver dichromate reagent and then the sample tube is placed in a boiling-water bath for 15 minutes. The tube is removed and cooled, 3 ml of water are added and then the green colour is measured in a suitable absorptiometer at 620 *mμ*. This test is suitable for 50 to 500 μg of fat. Lard dissolved in carbon tetrachloride can be used as a standard. Note that errors are most likely to be caused by inadequate removal of the solvents.

PROCEDURE FOR THE SULPHURIC ACID FRACTION—

Aliquots are taken for the determination of carbohydrate and phosphorus. Determination of phosphorus is performed in exactly the same way as for the phosphorus in the lipid fraction after 0.5 ml of 10 *N* sulphuric acid and 0.5 ml of 4 *N* perchloric acid have been added to the aliquot and the volume has been reduced as before.

Carbohydrate is determined by the anthrone method, as described by Trevelyan and Harrison.⁹

To each of a number of tubes, 5 ml of the anthrone solution are added and 1 ml of the solution to be tested is carefully inserted so as to form a layer on top of the reagent. At zero time the two layers are intimately mixed by means of a glass rod with a flattened end, which is plunged up and down once or twice in the mixture. The tubes are dealt with in strict rotation and are placed in a boiling-water bath immediately after mixing. After exactly 10 minutes (timed with a stop-watch), they are transferred in the same order to a bath of iced water. When the solutions are cool, the green colours are measured at 620 *mμ*. The useful range of the reaction is from 10 to 150 μg of glucose or its equivalent.

PROCEDURE FOR THE PERCHLORIC ACID FRACTION—

Total nucleic acids are determined by measuring the ultra-violet absorption at 268 *mμ*.⁸ Carbohydrate is then determined by the anthrone method as before in a 1-ml aliquot of the fraction. A 2-ml aliquot of the fraction is taken for the determination of deoxyribonucleic acid by the method of Ceriotti.¹¹

The 2-ml aliquot of the fraction is placed by pipette in a boiling-tube, and 1 ml of indole solution and 1 ml of concentrated hydrochloric acid are added. The tube is placed in a boiling-water bath for 10 minutes and then removed and cooled. The reaction mixture is extracted three times with 4-ml portions of chloroform and the chloroform extracts are discarded. The tube is then spun in a centrifuge for a short time at low speed in order to remove any emulsion that may have formed and the yellow colour is measured at 490 *mμ*. The useful range of the reaction is from 5 to 30 μg of deoxyribonucleic acid.

PROCEDURE FOR THE RESIDUAL FRACTION—

The residue consists almost entirely of protein and the protein nitrogen is determined as follows. To the residue is added 0.5 ml of the selenium dioxide solution. Water is removed by heating on a sand-bath and the mixture is then digested over an open flame until clear. Protein nitrogen is thus converted to ammonium sulphate and the ammonia can be determined by means of a modified Nessler' reagent.

The digestion mixture is diluted with distilled water to contain about 10 μg of nitrogen per ml. To 2 ml of this test solution are added 2 ml of the modified Nessler reagent and 3 ml of 2 *N* sodium hydroxide. After 15 minutes the yellow colour is measured at 490 $m\mu$.

RESULTS AND CONCLUSIONS

Table III shows that the recoveries of all substances were satisfactory.

TABLE III

RECOVERY OF MATERIALS ADDED TO THE VARIOUS FRACTIONS

Fraction	Material added	Amount of material originally present, μg	Amount of material added, μg	Amount of material found, μg	Recovery, %
Lipid	Fat	441	250	699, 673, 699, 699	101, 97.5, 101, 101
Sulphuric acid ..	Glucose	82.5	225	318.1, 318.1	103.5, 103.5
Perchloric acid ..	Glucose	28.2	150	190, 196	106, 110
Perchloric acid ..	Deoxyribonucleic acid*	18.2	7.75 15.5	26.5 31.7, 33.2	102 94, 98.5
Perchloric acid ..	Deoxyribonucleic acid†	4.44	1.83	6.27, 6.3, 6.4	100, 100.5, 102

* Determined by indole method. † Determined by ultra-violet absorption method.

Table IV shows the results of the analyses of a variety of tissues by this procedure. For all except embryonic chick heart, at least six samples were analysed so that the standard deviation of the determinations could be found. The analyses of embryonic chick heart indicate the degree of reproducibility between samples of about 1 mg dry weight.

TABLE IV

RESULTS OF THE FRACTIONATION AND ANALYSIS OF A VARIETY OF TISSUES BY THE METHOD DESCRIBED

Aliquots of mouse and embryonic chick liver were obtained from aqueous homogenates, of Ehrlich mouse ascites tumour and strain L cells from cell suspensions, and of embryonic chick heart from approximately equal amounts of tissue fragments

Tissue	Total lipid, mg	Carbohydrate (as glucose) in—			Protein nitrogen, mg.	Ribo-nucleic acid phosphorus, μg	Deoxyribo-nucleic acid phosphorus, μg
		sulphuric acid fraction, μg	perchloric acid fraction, μg	total, μg			
Ehrlich mouse ascites tumour ..	2.368	111.6	50	161.6	2.855	82.5	43.9
Mouse liver (ascitic) ..	± 0.099	± 3.3	± 1.35		± 0.15	± 1.36	± 0.171
Embryonic chick liver	1.428	759.6	563.6	1313.2	1.619	64.9	17.6
Embryonic chick heart A	± 0.062	± 48	± 50		± 0.072	± 1.19	± 0.165
Embryonic chick heart B	2.570	159.3	49.2	208.5	1.483	62.4	23.15
Embryonic chick heart C	± 0.062	± 0.78	± 3.33		± 0.033	± 2.36	± 1.26
Strain L mouse fibroblast*	0.094	75	44.5	119.5	0.107	3.57	1.836
	0.072	53.4	43	96.4	0.0914	3.54	1.63
	0.072	64.2	53.5	117.7	0.112	3.73	1.796
	0.610	0	22.7	22.7	0.268	17.2	24.52
	± 0.014		± 0.8		± 0.004	± 0.7	± 1.75

* Stored for some months in a deep-freeze cabinet before testing.

The results in Table IV are in agreement with other figures published for such tissues.

It may be noted that the general scheme that has been described is capable of considerable flexibility. Since an accurate determination of deoxyribonucleic acid is possible by omitting all the steps in the fractionation except extraction with hot perchloric acid,¹² it is possible

to omit various stages when only limited information is required. Also, when it is particularly desired to separate the different phosphorus fractions (usually for the determination of the incorporation of phosphorus-32), we have found it convenient to employ a Schmidt and Thannhauser separation after the sulphuric acid stage.

Instead of proceeding to the extraction with hot perchloric acid, 0.5 ml of *N* sodium hydroxide is added to the precipitate and it is incubated overnight (18 hours) at 37° C. After aliquots have been removed for determinations of carbohydrate and protein nitrogen, the digest is cooled to 0° C and 0.2 ml of 2.5 *N* hydrochloric acid and 0.3 ml of 4 *N* perchloric acid are added. Deoxyribonucleic acid is thereby precipitated and, after standing for 10 minutes at 0° C to allow the precipitate to flocculate, it can be separated by centrifugation in a refrigerated centrifuge. It is necessary to wash the precipitate twice with 0.5 ml of *N* perchloric acid each time. Ribonucleic acid phosphorus can be determined in the supernatant liquid and deoxyribonucleic acid phosphorus in the precipitate by digesting and continuing with the procedure described for lipid phosphorus.

This work was supported by grants from the Scottish Hospitals Endowments Research Trust. I thank Professor J. N. Davidson for the provision of facilities and Miss E. Pearson and Miss I. Withers for their assistance.

REFERENCES

1. Schmidt, G., and Thannhauser, S. J., *J. Biol. Chem.*, 1948, **161**, 83.
2. Davidson, J. N., Leslie, I., and Waymouth, C., *Biochem. J.*, 1949, **44**, 5.
3. Davidson, J. N., and Leslie, I., *Exp. Cell Res.*, 1951, **11**, 366.
4. Cailleau, R., Moss, S., and Siegel, B. V., *J. Nat. Cancer Inst.*, 1956, **16**, 1011.
5. Schneider, W. C., *J. Biol. Chem.*, 1945, **161**, 293.
6. Bloor, W. R., *Ibid.*, 1947, **170**, 671.
7. Ogur, M., and Rosen, G., *Arch. Biochem.*, 1950, **25**, 262.
8. Ceriotti, G., *J. Biol. Chem.*, 1955, **214**, 59.
9. Trevelyan, W. E., and Harrison, J. S., *Biochem. J.*, 1952, **50**, 299.
10. Griswold, B. L., Humoller, F. L., and McIntyre, A. R., *Anal. Chem.*, 1951, **23**, 192.
11. Ceriotti, G., *J. Biol. Chem.*, 1952, **198**, 297.
12. Paul, J., *J. Biophys. Biochem. Cytol.*, 1956, **2**, 797.

Received November 30th, 1956

Simultaneous Determination of Water and Carbon Dioxide in Rocks and Minerals

By J. P. RILEY

(Department of Oceanography, The University of Liverpool)

A method is described for the simultaneous determination of water and carbon dioxide in minerals and rocks. The samples are inserted in a combustion tube at 1100° to 1200° C; the resultant water and carbon dioxide are removed with a current of nitrogen, absorbed and determined gravimetrically. About twelve determinations can be made per day, since it is not necessary to allow the furnace to cool between analyses. Blank values for the apparatus are low, amounting to about 0.1 to 0.2 mg per hour. Water is completely removed from even the most resistant minerals, such as staurolite, within 30 minutes at 1200° C. The method showed a standard deviation of ± 0.04 per cent. with rocks containing about 5 per cent. of water when a 0.5-g sample was used.

A comparison has been made between a number of methods used for the determination of water in rocks and it was concluded that both the methods of Penfield and of Shapiro and Brannock tend to give low results owing to incomplete removal and absorption of water.

A KNOWLEDGE of the water content of rocks and minerals is of considerable importance to petrologists and mineralogists. The determination of water in rock samples by "loss on ignition" is still apparently being carried out at the present time by some petrologists,¹ even though it has been known for a long time to be unreliable. High results are caused by loss of volatile constituents other than water, such as sulphur or carbon dioxide. Low results

are due to gain in weight through oxidation of ferrous oxide to ferric oxide; this oxidation is usually not complete.

It is probable that the majority of water determinations at the present time are carried out by various modifications of the Penfield² method. In this procedure, the sample is heated in a bulb³ blown at one end of a hard-glass tube, and the liberated water is condensed further along the tube. The heated section is then drawn off. The portion containing the water is weighed and then weighed again after being thoroughly dried. There are two principal sources of error in the Penfield method, both of which cause the results to be low. It is difficult to ensure that all the liberated water is condensed, particularly under conditions of low relative humidity. Many common minerals retain some water up to at least 900° C, and therefore it may be almost impossible to remove all the water from the sample by heating in a glass tube. This difficulty may be minimised by carrying out the heating in a tube of fused silica, but the removal of the heated end of the tube is more difficult. Shapiro and Brannock³ have recently described a modification of the Penfield method, in which the sample is heated in a Pyrex-glass boiling-tube and the liberated water is retained in a weighed strip of filter-paper, which is then re-weighed. An empirical correction factor is used in the calculation of the results.

Probably the most accurate method for the determination of water in rocks is that in which the sample is heated in a combustion tube in a current of dry air and the expelled water is collected in a weighed absorption tube, the increase in weight of the absorption tube being determined. The procedure, as described by Groves,⁴ is rather time-consuming, since only three determinations can be carried out per day. The temperature (about 1000° C) used in expelling the water is not sufficiently high to remove all the water from the more refractory minerals, without the use of a flux, such as sodium tungstate, which requires the use of a platinum boat. The blank value is high, being between 0.7 and 3 mg.

In the method described by Groves, much time is spent in waiting for the combustion tube to cool between determinations. To speed up the process, the sample contained in an alumina boat was placed in the cold end of the silica combustion tube and then, after the end of the tube had been closed, it was inserted into the furnace by means of a stainless-steel rod sliding through a polytetrafluoroethylene washer. In order to ensure that all the water was expelled from the sample, the combustion tube was heated by means of an electric furnace to 1100° C, or to 1200° C if resistant minerals were present (the temperature was measured inside the combustion tube). At 1100° C all the water is removed from the majority of rocks in 20 minutes, and even refractory minerals, such as topaz, epidote and staurolite, give up all their water in about the same time at 1200° C.

The simultaneous determination of water and carbon dioxide in rocks and minerals has been described by Gooch^{5,6} and by Dittrich and Eitel,⁷ but in each method elaborate platinum apparatus is required.

When an attempt was made to determine the carbon dioxide and water simultaneously by heating at 1100° to 1200° C in a combustion tube and absorbing and weighing the resultant carbon dioxide and water, very high blank values for carbon dioxide were found. These were attributed to the formation of acidic oxides of nitrogen from the air used for sweeping out the apparatus. In order to reduce this error, nitrogen from a cylinder was used instead of air, and next to the main combustion tube was placed a further silica tube packed with short lengths of copper wire heated to 700° to 750° C to reduce oxides of nitrogen. Interference from sulphur compounds was prevented by a layer of silver pumice placed after the copper wire, and by a bubbler containing a saturated solution of chromium trioxide in phosphoric acid. With this apparatus extremely low blank values were found for both water and carbon dioxide (0.1 and 0.2 mg per hour, respectively).

METHOD

APPARATUS—

The apparatus used is shown diagrammatically in Fig. 1.

High-temperature furnace—The high-temperature furnace consists of an alumina tube, 22 cm long and having an external diameter of 4.2 cm, with 84 turns of 0.91-mm Kanthal A1 resistance wire on a 15-cm portion of the tube, the turns being more closely spaced at the ends of the tube than in the centre. The resistance wire is bedded in aluminous cement and the space between it and the 10-cm diameter silica outer jacket is packed with pure alumina. The furnace tube and the outer jacket were held in position by end plates made of Sindanyo.

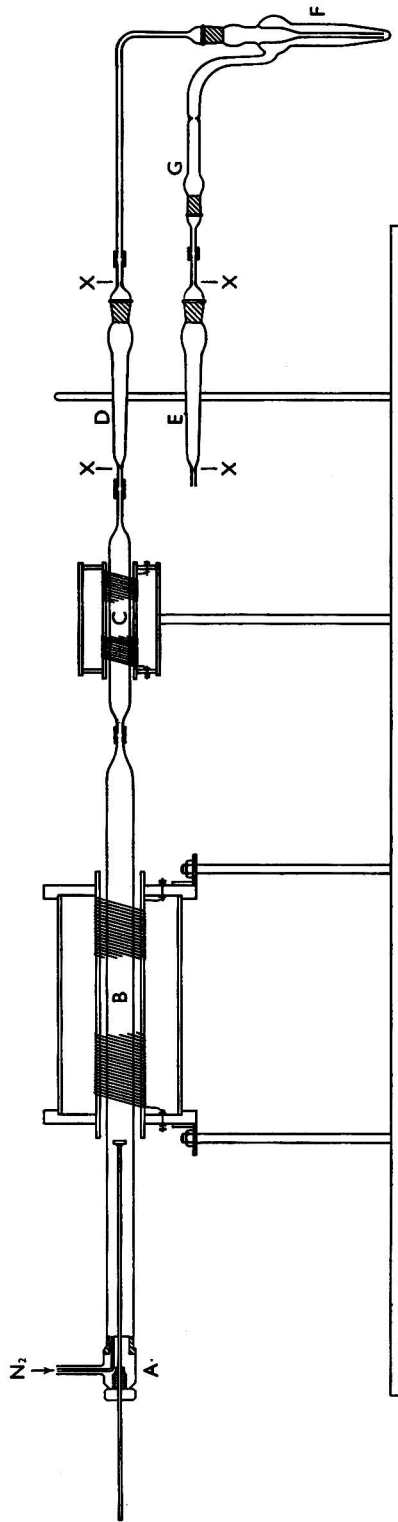

Scale: 2.2 inches = 1 foot

- A = Insertion device
- B = Silica combustion tube
- C = Silica tube containing copper wire and silver pumice
- D = Absorption tube containing magnesium perchlorate
- E = Absorption tube containing soda-asbestos
- F = Bubbler containing chromium trioxide
- G = Side-arm containing magnesium perchlorate

Fig. 1. Apparatus for determining carbon dioxide and water

Copper furnace—The low-temperature furnace consists of a translucent silica tube, 9 cm long and having an external diameter of 2.3 cm, with 16 turns of 1.58-mm \times 0.25-mm Nichrome tape on it. The whole is contained in a 6.3-cm diameter brass tube and the intervening space is packed with kieselguhr.

In operation, the two furnaces are run in series with one another. The high-temperature furnace is regulated to the desired temperature with a rheostat or Variac auto-transformer. The total energy dissipated at 1100° C is about 950 watts. Variation of the temperature of the copper furnace over the range 700° to 750° C is of no consequence.

Gas-purification train—Nitrogen gas (not of "oxygen-free" quality) from a cylinder is passed via a multistage regulator and needle valve, through a bubble counter containing concentrated sulphuric acid. It is purified by passage through tubes containing soda lime, fused calcium chloride and, finally, anhydrous magnesium perchlorate.

Insertion device—In order to avoid the necessity for allowing the combustion tube to cool between determinations, samples were pushed into the hot zone of the closed combustion tube by means of an insertion device, A. This consists of a brass stuffing box made airtight with a polytetrafluoroethylene washer, through which slides a stainless-steel pusher bar 35 cm long and 6 mm in diameter, with a 12-mm diameter head. The stuffing box is fitted with a brass tube for the introduction of nitrogen into the combustion tube and is connected to the latter by means of a rubber bung.

Combustion tube—The combustion tube, B, consists of a translucent silica tube, 45 cm long and having an internal diameter of 1.8 cm, fused at one end to a 3-cm length of silica tubing having an external diameter of 5 mm. The combustion tube is supported in the high-temperature furnace so that the 5-mm silica tube is about 10 cm outside it. Although the silica tube is being heated for long periods above the temperature recommended by the manufacturers (1000° C), no deterioration, except for slight sagging and a small amount of surface devitrification, has been noted even after several months' use. Attempts to use an impervious alumina combustion tube led to very variable blank values.

Copper tube—This tube, C, whose function is to remove sulphur compounds and oxides of nitrogen, consists of a translucent silica tube, 10 cm long and having an internal diameter of 1 cm, packed with alternate layers of copper wire and silver pumice (prepared by evaporating 14-mesh pumice with strong silver nitrate solution and igniting strongly) held in place by asbestos plugs. Both ends of the tube are fused to 3-cm lengths of silica tubing having an external diameter of 5 mm. At least once a week a current of coal gas should be passed for 15 minutes through the heated tube to reduce any copper oxide to the metal. The life of the tube is about 3 months with rocks of low sulphur content.

Absorption tubes—The absorption tubes are 14 cm long and have a 1-cm bore; a tube having an external diameter of 5 mm is sealed on at one end and a B10 socket at the other. They are closed by means of B10 cones fused close to the joint to the 5-mm tubing. The narrow tubing at each end is constricted at X to a capillary having a bore of about 1 mm. If samples containing much carbonate are to be analysed, an absorption tube of larger diameter (1.5 cm) should be used for the collection of carbon dioxide.

The water absorption tube, D, is filled with anhydrous magnesium perchlorate. The carbon dioxide absorption tube, E, is packed with an 8-cm layer of soda asbestos and a 2-cm layer of anhydrous magnesium perchlorate. The stoppers of both absorption tubes are cemented in position with hard black wax. Connection of the absorption tubes is made with aged rubber tubing.

Chromium trioxide bubbler—With samples containing more than 0.5 per cent. of sulphur, the bubbler, F, filled with a saturated solution of chromium trioxide in 85 per cent. phosphoric acid, should be interposed between the water absorption tube, D, and the carbon dioxide absorption tube, E. Its side-arm, G, is packed with magnesium perchlorate.

PROCEDURE—

For the analysis of the majority of rock samples, the main furnace should be run at 1100° C; if difficultly decomposable minerals such as staurolite are present, the temperature should be raised to 1200° C. The flow of nitrogen should be regulated to about 3 litres per hour. Each day before use, allow nitrogen to pass through the apparatus and absorption tubes for about 20 minutes. Remove the absorption tubes, wipe them carefully and weigh them after 5 minutes.

Weigh 0.5 to 1.5 g of sample into a previously ignited 2-ml alumina boat lined with a piece of nickel foil. If much fluoride or sulphur is present, cover the sample with a layer of freshly ignited magnesium oxide. Insert the boat into the end of the combustion tube, replace the insertion device, and allow nitrogen to sweep air out of the apparatus for 5⁴ minutes. Connect the weighed absorption tubes, and then push the sample into the furnace by means of the stainless-steel rod. When large amounts of readily decomposable carbonates, such as siderite and magnesite, are present, the boat should not be pushed immediately into the hot part of the furnace, since this leads to such rapid evolution of carbon dioxide that it is not completely absorbed. Such samples should be allowed to decompose in the cooler region just outside the furnace, and only after decomposition is nearly complete should the sample be subjected to the full temperature. After a heating period of 30 to 40 minutes, remove the absorption tubes, wipe them and weigh them after 5 minutes. Carry out a blank determination in the same manner, without the sample, before the first determination and at the end of work. The normal blank values for the water and carbon dioxide are 0.1 and 0.2 mg per hour, respectively. When higher blank values are found for carbon dioxide, the copper tube is exhausted and should be treated as described on p. 45.

COMPARISON OF METHODS FOR THE DETERMINATION OF WATER IN ROCKS AND MINERALS

In order to compare the precision of different methods for the determination of water, nine samples of metamorphic rocks (ground to pass an 80-mesh sieve) were examined by the proposed method, by the Penfield method² (heating for 20 minutes in a tube of Pyrex glass), by the Penfield method, but with lead oxide used as flux, and by the method of Shapiro and Brannock.³ "Loss on ignition" was determined by heating the sample in an uncovered platinum crucible at 1000° C for 30 minutes. The results are shown in Table I, each figure being the mean of at least two determinations.

The ferrous iron content of the residue remaining after the determination of "loss on ignition" is very variable, ranging from 0.16 to 3.0 per cent. Considerable errors can be caused by correcting the "loss on ignition" figure on the assumption of complete oxidation of ferrous iron. Even when correction is made only for the amount of ferrous iron actually oxidised, results tend to be high, owing to loss of carbon dioxide and sulphur. This is particularly noticeable with samples Nos. 1502c, 1698c and 1698u, which contained appreciable amounts of pyrite. When sulphides and carbonates are absent, "loss on ignition" results are in fair agreement with those by other methods.

In general, it will be seen that the results by the proposed method are appreciably higher than those by the other methods (except for "loss on ignition"); this is attributed to more efficient removal and collection of water. This difference suggests that the water contents given in many earlier analyses of rocks and minerals (particularly amphiboles and micas) may be significantly low.

The figures obtained by the methods of Shapiro and Brannock and of Penfield (without flux) are in fair agreement with one another. The comparatively low temperature (less than 800° C) and short period of heating used makes the complete removal of water by these procedures unlikely. This is the reason for the conspicuous failure of both methods with the moderately resistant hornblendite (sample No. 1971). When lead oxide was used as a flux in the Penfield method, the results were higher, but they were still lower than those by the proposed method. This error is caused by a fundamental flaw in the Penfield method and its modifications, *i.e.*, failure to condense all the liberated water. Shapiro and Brannock have attempted to correct for this loss by the use of an empirical correction factor, but the results in Table I suggest that their correction factor is too low.

A study of the reproducibility of the methods with the garnet - sillimanite - biotite schist (sample No. 2096) showed standard deviations of 0.04, 0.13 and 0.10 per cent., for the proposed method, the Penfield method, with flux, and the method of Shapiro and Brannock, respectively.

EXAMINATION OF REFRACTORY MINERALS

Several minerals, such as talc, topaz and epidote, do not give up all their water at temperatures below 1100° C. The rate of loss of water from these minerals at 1200° C was therefore studied, and it was found that with every mineral, loss of water was complete after heating for 30 minutes. In order to test the method, replicate determinations of the water content were carried out on the minerals, which had been ground to pass an 80-mesh sieve. Check

TABLE I
COMPARISON OF METHODS FOR THE DETERMINATION OF WATER IN ROCKS

Sample No.*	Rock type	Loss on ignition				Residual FeO, %	Penfield method, %	Penfield method with PbO, %	Shapiro method, %	Proposed method, %
		Un-corrected, %	Corrected Al ⁺ , %	Corrected B ⁺ , %	FeO, %					
672	Biotite - garnet schist	2.35	3.39	3.24	9.42	2.32	2.88	2.48	2.98	
734	Garnet - sillimanite - sericite schist	4.48	5.62	5.41	10.29	5.19	5.54	4.91	5.47	
1153	Garnet - cordierite hornfels	2.70	4.02	3.69	11.91	3.01	2.83	2.94	3.27	
1502c	Garnet - cordierite hornfels	4.17	5.84	5.59	9.58	4.38	4.37	4.47	4.67	
1698c	Cordierite - garnet - biotite hornfels	3.80	4.79	4.50	8.92	2.29	3.94	3.86	4.10	
1698u	Biotite-rich cordierite hornfels	3.08	4.33	4.16	11.13	1.50	3.65	3.41	3.70	
1714	Biotite - sericite schist	3.58	4.53	4.53	8.70	3.93	4.22	3.99	4.50	
1971	Hornblendite	1.19	1.98	1.96	7.15	0.16	2.42	1.44	2.57	
2096	Garnet - sillimanite - biotite schist	3.57	4.65	4.40	9.82	2.28	4.03	3.80	4.32	

* Sample number refers to the catalogue number of the sample in the collection of the Geology Department, University of Liverpool. All samples originated from Cashel, Co. Galway, Eire.

† On the assumption of total oxidation of ferrous iron.

‡ On the assumption of partial oxidation of ferrous iron.

§ Containing 0.58 per cent. of sulphur.

TABLE III
SIMULTANEOUS DETERMINATION OF WATER AND CARBON DIOXIDE IN CARBONATE MINERALS

Method	Magnesite		Calcite		Strontianite		Dolomite		Siderite		Scapolite	
	Carbon dioxide found, %	Water found, %	Carbon dioxide found, %	Water found, %	Carbon dioxide found, %	Water found, %	Carbon dioxide found, %	Water found, %	Carbon dioxide found, %	Water found, %	Carbon dioxide found, %	Water found, %
Chemical*	50.20	—	43.80	—	29.03	—	47.26	—	38.27	—	5.23†	—
By simultaneous determination	50.40	0.84	43.80	0.51	29.14	0.35	47.15	0.40	38.37	0.25	5.25	0.58
	50.40	0.81	43.80	0.54	29.15	0.44	47.23	0.40	38.30	0.23	5.37	0.63
	50.55	0.75	43.70	0.57	29.07	0.50	47.30	0.42	38.20	0.20	5.48	0.66
	50.40	0.81	43.65	0.48	29.03	—	47.40	0.50	38.40	0.25	5.41	0.63
	Mean	50.44	0.80	43.74	0.53	29.10	0.43	47.27	0.43	38.32	0.24	5.38

* Method described by Groves.*

† Result given by Manchot and Lorenz's method.*

determinations were also made as described by Groves,⁴ with sodium tungstate as flux. The results, which are shown in Table II, indicate that the recoveries of water are satisfactory.

TABLE II
WATER RECOVERED FROM RESISTANT SILICATES

Method	Water found in				
	Epidote, %	Staurolite, %	Topaz, %	Talc, %	Phlogopite, %
Sodium tungstate flux ..	1.96	1.83	1.69	4.82	2.72
	1.96	1.85	1.64	4.86	2.77
	1.96	1.85	1.65	4.87	2.78
Proposed method (1200° C)	1.97	1.86	1.67	4.89	2.77
	2.00	1.87	1.67	4.90	—
	2.01	1.88	1.68	—	—
	—	1.89	—	—	—
	Mean	1.98	1.87	1.66	4.88

SIMULTANEOUS DETERMINATION OF WATER AND CARBON DIOXIDE

In order to test the proposed method for the determination of carbon dioxide, several carbonate minerals were examined. The results are shown in Table III (p. 47), together with the carbon dioxide contents determined chemically.⁸ In each case the agreement is satisfactory.

The temperature at which the dissociation pressure of the carbon dioxide of carbonates becomes 1 atmosphere differs widely with the metallic radicle present, *e.g.*, ferrous carbonate at 490° C; magnesium carbonate at 540° C¹⁰; calcium carbonate at 900° C¹¹; strontium carbonate at 1289° C¹²; barium carbonate 1360° C. Samples that have low dissociation temperatures should be allowed to decompose initially for 10 minutes in the hot region just outside the furnace. If such samples are subjected immediately to the full temperature of the furnace, there is serious risk of loss of carbon dioxide by incomplete absorption, owing to its too rapid evolution.

The vapour pressure of carbon dioxide over strontianite (SrCO₃) at 1200° C is sufficiently high to ensure the complete removal of carbon dioxide in 30 minutes. On the other hand, the vapour pressure of carbon dioxide over barium carbonate is so low at this temperature that only partial removal of the carbon dioxide (70 to 80 per cent.) occurs in 30 minutes. Complete recovery can be obtained if the heating period is prolonged to 3 hours.

The carbon dioxide content of scapolite is difficult to determine chemically, since the mineral is not completely attacked by phosphoric acid and must be decomposed with hydrofluoric acid.⁹ Its carbon dioxide is strongly retained at 1100° C, and a temperature of 1200° C must be used for the decomposition; under these conditions the results obtained for this mineral agree well with those found chemically by using hydrofluoric acid.

As a further test of the method, replicate analyses of four metamorphic rocks, low in carbonate, were carried out for water and carbon dioxide. The results are shown in Table IV.

TABLE IV
SIMULTANEOUS DETERMINATION OF WATER AND CARBON DIOXIDE IN ROCKS

Sample No.	Carbon dioxide found, %	Water found, %
1564	0.46, 0.48, 0.50, 0.43	3.72, 3.71, 3.68, 3.69
1760	0.71, 0.75, 0.70, 0.76	4.14, 4.13, 4.17, 4.15
1431	0.17, 0.18, 0.15, 0.16	6.08, 6.12, 6.07, 6.11
1460A	0.27, 0.32, 0.33, 0.31	4.55, 4.58, 4.60, 4.50
Sample No.	Rock type	
1564	Cordierite - spinel - plagioclase hornfels.	
1760	Cordierite - plagioclase - biotite hornfels.	
1431	Cordierite - biotite - spinel hornfels.	
1460A	Magnetite - spinel - biotite hornfels.	

The sample number refers to the catalogue number of the sample in the collection of the Geology Department, University of Liverpool. All samples originated from Cashel, Co. Galway, Eire.

From the results it is seen that satisfactory reproducibility was achieved for both water and carbon dioxide.

In order to check the efficiency of the silver pumice and chromium trioxide trap for the prevention of interference by sulphur, 30-mg samples of sulphur and chalcopyrite were analysed; with neither substance was the gain in weight of the soda-asbestos tube greater than 0.3 mg. If samples to be analysed are known to contain fluorine, sulphur or sulphides, it is advisable to cover the samples with a layer of magnesium oxide to prolong the life of the silver pumice.

A more serious error in the determination of carbon dioxide results from the presence of graphite or organic carbon in the samples. Such materials are completely burnt to carbon dioxide. The carbonate-carbon in these materials should be determined by the conventional method in which phosphoric acid is used.⁸ The organic carbon content of muds may be found by determining the carbonate-carbon by the conventional method and total carbon by combustion.

I thank Mr. P. Sinhaseni for assistance in the preparation of Fig. 1, and also Professor R. M. Shackleton and Dr. B. Leake for providing the rock and mineral samples used in the investigation.

REFERENCES

1. Fairbairn, H. W., "A Co-operative Investigation of Precision and Accuracy in Chemical, Spectrochemical and Modal Analysis of Silicate Rocks," U.S. Geol. Survey, Bull. 980, 1951, pp. 21-22.
2. Penfield, S. L., *Amer. J. Sci.*, 1894, **48**, 30.
3. Shapiro, L., and Brannock, W. W., *Anal. Chem.*, 1955, **27**, 1796.
4. Groves, A. W., "Silicate Analysis," Second Edition, George Allen & Unwin Ltd., London, 1951, p. 97.
5. Gooch, F. A., *Amer. Chem. J.*, 1880, **2**, 247.
6. —, *Chem. News*, 1880, **42**, 326.
7. Dittrich, M., and Eitel, W., *Z. anorg. Chem.*, 1912, **75**, 373.
8. Groves, A. W., *op. cit.*, p. 112.
9. Manchot, W., and Lorenz, L., *Z. anorg. Chem.*, 1924, **134**, 316.
10. Remy, H., "Lehrbuch der anorganischen Chemie," Band I, S 225, Akad. Verlag, Leipzig, 1931.
11. Dutoit, W., *J. Chim. Phys.*, 1926, **24**, 110.
12. Tamman, G., and Pape, W., *Z. anorg. Chem.*, 1923, **127**, 50.

Received July 15th, 1957

Recommended Methods for the Analysis of Trade Effluents

PREPARED BY THE JOINT A.B.C.M. - S.A.C. COMMITTEE ON METHODS FOR THE ANALYSIS OF TRADE EFFLUENTS

Methods for the Determination of Phosphorus and Acid-soluble Sulphate

Phosphorus

PRINCIPLE OF METHOD—

Phosphorus may be present in effluents as phosphate (ortho-, meta-, pyro- or polyphosphate) and in organic combination.

The phosphorus is first converted to orthophosphate, if not already present as such. This is then determined colorimetrically (by using Tschopp's reagent) as the molybdenum blue complex formed by the reduction of molybdophosphoric acid.

RANGE—

For phosphorus contents of (a) up to 75 μg (instrumental method);
or (b) up to 25 μg (visual colour-comparison method).

APPLICABILITY—

The method is of wide application. Ferric iron in concentrations several times that of the phosphorus does not interfere.

The conditions of test may be modified to differentiate between total inorganic phosphate and total phosphorus present in the effluent.

NOTE—It is possible that extraction procedures^{1,2} may be of assistance in eliminating interferences. In these procedures the molybdophosphoric acid is extracted by a solvent such as *n*-butanol, and the reduction is subsequently carried out in this medium.

REAGENTS—

Ammonium molybdate solution—Dissolve 10 g of ammonium molybdate, $(\text{NH}_4)_6\text{Mo}_7\text{O}_{24}\cdot 4\text{H}_2\text{O}$, in 100 ml of distilled water. Add this solution slowly, and with stirring, to 300 ml of diluted sulphuric acid (1 + 1). Store in a borosilicate-glass bottle in the dark.

Standard phosphate solution A—Dissolve 0.439 g of potassium dihydrogen orthophosphate in distilled water, add 5 ml of diluted sulphuric acid (1 + 1) and dilute the solution to 1 litre.

Standard phosphate solution B—Dilute 10.0 ml of solution A to 1 litre with distilled water. Prepare this solution freshly each day.

1 ml \equiv 1 μg of phosphorus.

Metol - sulphite solution (Tschopp's reagent)—Dissolve 40 g of sodium metabisulphite and 1 g of sodium sulphite, $\text{Na}_2\text{SO}_3\cdot 7\text{H}_2\text{O}$, in cold distilled water, add 0.2 g of Metol (*p*-methylaminophenol sulphate) and stir well until solution is complete. Dilute to 100 ml with distilled water and mix.

PROCEDURE—

(a) Total inorganic phosphate—

Select a suitable volume of the effluent sample (not exceeding 10 ml) to contain up to 75 μg of phosphorus if the determination is to be made instrumentally, or up to 25 μg if visual colour comparison is to be made.

Add sufficient sulphuric acid to make the acidity 5 *N* and boil the solution for 15 minutes, to convert any condensed phosphates to orthophosphate, keeping the volume constant. Cool, filter, if necessary, and almost neutralise to phenolphthalein with sodium hydroxide solution.

Add 5 ml of ammonium molybdate solution and 5 ml of Metol - sulphite solution. Heat the solution in a boiling-water bath for 30 minutes and then cool to room temperature. Transfer the solution to a 50-ml calibrated flask and dilute to the mark^a with distilled water.

Carry out a blank determination on all reagents used. Proceed to determine the phosphorus content colorimetrically, either by the instrumental method or by visual colour comparison.

Instrumental method—Measure the optical densities of the test and blank solutions in a spectrophotometer or in an absorptiometer, using 4-cm or 1-cm cells according to the depth of colour, and using a wavelength of 6500 Å in a spectrophotometer or a suitable red filter in an absorptiometer. Use distilled water in the comparison cell. Read the number of micrograms of phosphorus equivalent to the observed optical densities of the test and blank solutions from a previously prepared calibration graph, and so obtain the net measure of inorganic phosphate (as phosphorus) in the sample.

Prepare the calibration graph as follows—

Measure appropriate amounts of standard phosphate solution B into a series of conical flasks: for the 4-cm cell the standards should cover the range 0 to 10 µg and for the 1-cm cell they should cover the range 10 to 75 µg of phosphorus. To the contents of each flask add 5 ml of ammonium molybdate solution and 5 ml of Metol - sulphite solution and proceed as for the test sample. Measure the optical densities and construct a graph relating the optical densities to the number of micrograms of phosphorus.

Visual colour-comparison method—Prepare a series of standards as for the instrumental method, covering the range 0 to 25 µg of phosphorus. Compare the colours visually in Nessler cylinders.

Alternatively, proprietary coloured discs may be used in a comparator instead of solution standards, and the makers' instructions should be followed. It should be noted that some proprietary coloured discs are calibrated in terms of P₂O₅; the conversion factor to phosphorus is 0.437.

Whichever method of determination is used (instrumental or visual comparison), express the total inorganic phosphate content as milligrams of phosphorus per litre of sample.

(b) Total phosphorus—

Digest 5 to 10 ml of the effluent sample, over a micro-burner, with 0.3 to 0.5 ml of sulphuric acid, sp.gr. 1.84, in a micro-Kjeldahl flask or boiling-tube. Continue the digestion until the solution is colourless, avoiding loss by fuming. Cool and transfer the solution to a 50-ml calibrated flask, rinsing the digestion vessel with sufficient distilled water to bring the volume to about 20 ml; filter if necessary. Almost neutralise the solution to phenolphthalein with sodium hydroxide solution. Finally, dilute the solution to the mark with distilled water.

Measure a suitable aliquot of this solution and proceed as described under "Total Inorganic Phosphate," commencing at "Add 5 ml of ammonium molybdate solution . . ." in (a) above.

Carry out a blank determination on all reagents used.

Express the total phosphorus content as milligrams of phosphorus per litre of sample.

REFERENCES

1. Pons, W. A., and Guthrie, J. D., *Ind. Eng. Chem., Anal. Ed.*, 1946, 18, 184.
2. Martin, J. B., and Doty, D. M., *Anal. Chem.*, 1949, 21, 965.

Acid-soluble Sulphate

PRINCIPLE OF METHOD—

The acid-soluble sulphates are precipitated as barium sulphate under controlled conditions¹ and determined gravimetrically.

RANGE—

For sulphate contents between 8 and 60 mg, expressed as SO_4'' .

APPLICABILITY—

The method is generally applicable. If it is desired to include the sulphate ion of insoluble compounds, such as barium sulphate, an appropriate aliquot of the well-mixed sample must be neutralised, made slightly acid with hydrochloric acid, evaporated to dryness, ignited and the usual methods of quantitative gravimetric analysis applied to the residue.

REAGENTS—

Hydrochloric acid, sp.gr. 1.18.

Hydrochloric acid, diluted (1 + 1).

Hydrochloric acid, dilute, approximately 0.5 N.

Ammonium hydroxide, diluted (1 + 3)—Dilute 1 volume of ammonium hydroxide, sp.gr. 0.880, with 3 volumes of distilled water.

Barium chloride solution, 10 per cent. w/v.

Methyl orange indicator solution—A 0.04 per cent. w/v solution in 20 per cent. ethanol.

PROCEDURE—

Measure an aliquot of the effluent sample which is expected to contain between 8 and 60 mg of acid-soluble sulphate. Neutralise with 0.5 N hydrochloric acid, using methyl orange indicator solution; then add 1 ml of hydrochloric acid, sp.gr. 1.18, and boil the mixture. Adjust the volume to about 150 ml by concentration or dilution with distilled water. Filter the solution and wash the residue on the filter-paper until the washings are free from chloride.

Neutralise the combined filtrate and washings with diluted ammonium hydroxide (1 + 3), adding more indicator solution if necessary. Adjust the volume to about 200 ml with distilled water, add 2 ml of diluted hydrochloric acid (1 + 1) and heat to boiling. Boil the solution for about 30 seconds, remove it from the hot-plate and add 10 ml of barium chloride solution (or 15 ml if less than 20 mg of sulphate are present) from a fast-flowing pipette to the centre of the solution, with thorough mixing. Allow the mixture to stand for 20 minutes; then filter off the precipitate on an ashless filter-paper pulp pad, using gravity filtration and washing with hot distilled water until the washings are free from chloride.

Transfer the wet pad and precipitate to a previously ignited and weighed silica capsule, wiping off with a piece of moist filter-paper any precipitate adhering to the funnel, insert the capsule on a 6-mm silica plate directly into a well-ventilated muffle furnace at 800° C, ignite, cool and weigh the barium sulphate.

Weight of BaSO_4 (in mg) $\times 0.4116 = \text{mg of sulphate (as } \text{SO}_4'')$.

Express the result as milligrams of acid-soluble sulphate (as SO_4'') per litre of sample.

REFERENCE

1. Mott, R. A., Ruell, D. A., and Wilkinson, H. C., *Fuel*, 1955, **34**, 78 and 87.

Notes

THE DETERMINATION OF MANGANESE IN TITANIUM

THE persulphate oxidation - sodium arsenite titration method is recommended¹ for determining manganese in titanium. This is a well established method used in steel analysis, phosphoric acid being added to extend the range of the method and to improve the end-point. Phosphate cannot be tolerated when a large amount of titanium is present, because a titanium phosphate is precipitated under the conditions of the method. The behaviour of anions, other than orthophosphate, was therefore investigated. It was shown that fluoride could be used in place of phosphate.

EXPERIMENTAL

The method recommended by the Panel on Methods of Analysis,¹ which is based on oxidation of a solution of the sample in sulphuric acid with ammonium persulphate in the presence of silver nitrate, was investigated.

It was found that, if more than 10 mg of manganese are present, manganese dioxide is precipitated when the ammonium persulphate is added. The end-point of the titration becomes difficult to determine as the amount of titanium present is increased. The method is empirical, and the effective normality of the sodium arsenite and the colour of the end-point depend upon the amount of titanium present and the manganese concentration.

Sodium fluoride was added after the metal had dissolved and the procedure was continued as described in the standard method. A visual improvement was noted in the colour change, which was from pink to yellow-green, rather than pink to yellow-brown. When no titanium is present, the presence of fluoride causes the end-point to be from pink to colourless. The greenish shade appears when titanium is present (1 g) and the yellow becomes more visible as the manganese content increases.

POTENTIOMETRIC TITRATIONS—

The end-points obtained with and without sodium fluoride were compared by potentiometric titration. One gram of titanium was dissolved as in the Panel Method¹ and various amounts of manganese were added as manganese sulphate. The manganese was oxidised with 15 ml of 25 per cent. ammonium persulphate solution in the presence of 10 ml of 0.8 per cent. silver nitrate solution. The solutions with and without sodium fluoride present were titrated with sodium arsenite. Platinum and calomel electrodes were used. Because of the silver ions present in the solution, a sodium sulphate salt bridge was used between the calomel and the solution. The break is sharper when fluoride is present, and at the end-point without fluoride present there is a drift that is not detected in the presence of fluoride.

RANGE OF METHOD—

When fluoride is present, up to 25 mg of manganese can be oxidised without any precipitation of manganese, provided the conditions are controlled correctly. It was found that, if the ammonium persulphate was added at the boiling-point and the solution was then boiled for 1 minute, no precipitation occurred, and reproducible end-points were obtained. The results obtained on titrating various amounts of manganese in the presence of 0.5 g of titanium with sodium arsenite solution (3.85 g per litre) after the addition of 5 g of sodium fluoride, and then silver nitrate and ammonium persulphate in the usual manner, were as follows—

Manganese added, mg	3.48	6.96	13.92	17.40	20.88	25.00
Volume of sodium arsenite solution used, ml (average of five results)	4.10	8.18	15.35	19.20	23.25	27.50
Standard deviation	0.01	0.02	0.03	0.03	0.04	0.05

The standard deviation increases with the amount of manganese present. The method is empirical, the effective normality of the sodium arsenite depending upon the amount of manganese present.

TITANIUM CONTENT—

Experiments were performed in which the titanium content was varied, but a constant amount of manganese was present; the amount of manganese was 5.02 mg in each solution and the results on titrating with sodium arsenite solution (3.85 g per litre) were—

Titanium added, mg	100	500	1000
Volume of sodium arsenite solution used, ml	6.22	5.95	5.60

It can be seen from the results given that the sodium arsenite solution must be standardised under conditions such that the manganese and titanium concentrations are similar to those in the sample.

RESULTS

Table I shows the results obtained in the analysis of titanium - manganese alloys, prepared by arc-melting sintered titanium powder and manganese metal. The method as described by the Panel¹ plus the addition of 5 g of sodium fluoride, was used.

TABLE I
ANALYSIS OF TITANIUM - MANGANESE ALLOYS

Nominal composition: manganese, %	Sample weight, g	Average of five results for manganese, %	Standard deviation	Range of results
2.00	0.5	2.02	0.002	0.01
4.00	0.5	4.03	0.006	0.02
6.00	0.25	6.04	0.01	0.04
8.00	0.25	8.08	0.02	0.04

REFERENCE

1. Metallurgical Advisory Committee on Titanium, "Recommended Methods of the Panel on Methods of Analysis," *Information Bulletin No. T 8*, Part I, Ordnance Corps, U.S.A., 1955.

COMMONWEALTH SCIENTIFIC AND INDUSTRIAL RESEARCH ORGANISATION
PHYSICAL METALLURGY SECTION
BAILLIEU LABORATORY
UNIVERSITY OF MELBOURNE

J. A. CORBETT
Received March 19th, 1957

THE APPLICATION OF THE POLARISED PLATINUM ELECTRODE TO THE DETERMINATION OF ASCORBIC ACID IN FRUIT PRODUCTS

(Presented at the meeting of the Western Section on Saturday, November 10th, 1956)

THE "dead-stop" method of Foulk and Bawden¹, in which polarised platinum electrodes are used, as adapted by Liebmann and Ayres² for the determination of ascorbic acid by titration with 2:6-dichlorophenolindophenol, has been used in these laboratories for many years. The end-point is determined graphically from plots of galvanometer deflections read 25 seconds after each 0.02-ml addition of dye solution. The additions of the dye solution are made at 30-second intervals.

It was found that for low concentrations of ascorbic acid the slope of the plots after the end-point was reduced and so a loss of precision resulted. In addition, the galvanometer deflection, on occasions, would be still altering when the time came for its value to be noted. The effect was especially noticeable when the frequency of the additions of dye solution was increased in an effort to improve the precision. The modifications described below were the outcome of attempts to improve the precision of the method.

The method described by Sully³ was used, in which the e.m.f. is applied to the electrodes through a very high resistance of 2 to 3 megohms, and the potential across them is measured by means of an electronic millivoltmeter. When the system is polarised, a high e.m.f. is observed, but it is reduced when depolarisation takes place.

It was found that the system, when partly depolarised by a small temporary excess of oxidant, became progressively slower to recover as the end-point was approached. By reducing the size of the electrodes to that of pin heads, by cutting them off flush with the glass surface, the sluggish response was largely overcome. This effect was presumed to be due to the smaller surface area of the electrodes, which would require less reductant to achieve polarisation.

The method finally adopted made use of electrodes of small surface area as described above. A Mullard millivoltmeter as supplied with a well known electrometric titration outfit was used for measuring the e.m.f. The circuit of the millivoltmeter was modified so that the existing polarising voltage could be applied through a 2.2-megohm resistor and the voltage was reduced to approximately 260 mV by means of a suitable tapping off the bias resistor network of the first valve in the instrument.

The titration was performed in a small flat-bottomed tube. Two millilitres of extract were taken and mixing was carried out by means of a stream of oxygen-free nitrogen. The dye solution was added in 0.01-ml increments at 20-second intervals near the end-point. The e.m.f. was

measured 15 seconds after each addition of dye solution. The concentration of the dye was approximately equivalent to 0.4 mg of ascorbic acid per ml and was standardised against 0.005 N potassium iodate.

RESULTS AND DISCUSSION

The modifications described resulted in an increase of precision. The coefficient of variation for quadruplicate determinations on a solution of blackcurrant syrup was 0.6 per cent., compared with 1.4 per cent. by the original method. A similar test on a solution of ascorbic acid gave 0.33 and 1.0 per cent. It is thought that the improvement may be due to the reduction of the current through the system at the end of the titration from 0.4 to 0.05 μ A. Three assays on pure ascorbic acid gave 100.0, 99.7 and 100.3 per cent., which indicate good accuracy.

Evans and Simmonds⁴ have discussed the mechanism of polarisation end-points with special reference to dilute solutions of iodine and sodium thiosulphate. They state that under certain conditions there may be insufficient anions to keep the cathode depolarised. This effect was shown by a very slow fall in e.m.f. when dye solution was added to 2 per cent. oxalic acid solution in the original method. When the modified circuit was used, a sharp fall in e.m.f. was observed. These observations support the view that, the smaller the size of the electrode, the lower the concentration of anions necessary to depolarise it.

In order to test the effect of anions on the results obtained by the method, a solution of blackcurrant syrup and a dilute solution of ascorbic acid were both assayed with and without the addition of 2 mg of chloride as potassium chloride. The results are shown in Table I.

TABLE I
EFFECT OF CHLORIDE ON THE DETERMINATION OF ASCORBIC ACID

Sample	Ascorbic acid found in 2 ml of sample, mg	Ascorbic acid found in 2 ml of sample with 2 mg of chloride added, mg
Ascorbic acid solution	0.042 (8), 0.042	0.042, 0.041 (6)
Blackcurrant syrup solution A ..	0.392, 0.387	0.382, 0.383
Blackcurrant syrup solution B ..	0.426, 0.430	0.430, 0.429

In all tests the differences were within the experimental error of the method. The modified method has, therefore, the advantage of increased precision with no loss in accuracy, and it is not affected by concentrations of chloride up to 1 mg per ml of titrating solution.

REFERENCES

1. Foulk, C. W., and Bawden, A. T., *J. Amer. Chem. Soc.*, 1926, **48**, 2044.
2. Liebmann, H., and Ayres, A. D., *Analyst*, 1945, **70**, 411.
3. Sully, B. D., *Chem. & Ind.*, 1955, 1146.
4. Evans, D. P., and Simmonds, N. T., *J. Soc. Chem. Ind.*, 1944, **63**, 29.

THE ANALYTICAL LABORATORY
H. W. CARTER & CO. LTD.
THE ROYAL FOREST FACTORY
COLEFORD, GLOS.

R. C. CURTIS
Received December 11th, 1956

A NOTE ON SILVER NITRATE TITRATIONS

WHEN solutions of sodium or potassium chloride are titrated with silver nitrate, with dichloro-fluorescein as indicator, a more accurate and clear-cut end-point is obtained by observing the character of the precipitate. At the end-point the precipitate breaks down and becomes finely divided and granular in appearance. The colour changes in the supernatant liquid and of the precipitate are useful associated indications of the end-point, but are difficult to describe by themselves. With 0.1 M solutions, this end-point gives reproducible results in agreement with those obtained by the Mohr method corrected for a blank.

No comparable reproducible change in the character of the precipitate occurs in titrating solutions of sodium or potassium bromide, iodide or thiocyanate with silver nitrate.

DEPARTMENT OF CHEMISTRY
THE QUEEN'S UNIVERSITY OF BELFAST
N. IRELAND

W. F. N. LEITCH
F. A. LEWIS
Received August 2nd, 1957

Apparatus

A COMPACT UNIT FOR POTENTIOMETRIC AND "DEAD-STOP END-POINT" TITRIMETRY

ASSEMBLED mainly from radio components, the transistor-operated arrangement shown in Fig. 1 is generally suitable for normal, differential and "dead-stop end-point" titrimetry. High-resistance titration systems, such as those involving the glass electrode, are excluded, since the titrimeter draws a current of a few microamperes from the system. Even with transistors selected at random, the zero is stable and the response is closely linear. An input e.m.f. of 100 mV produces meter readings of about 10 and 50 μ A, respectively, at minimum and maximum sensitivity.

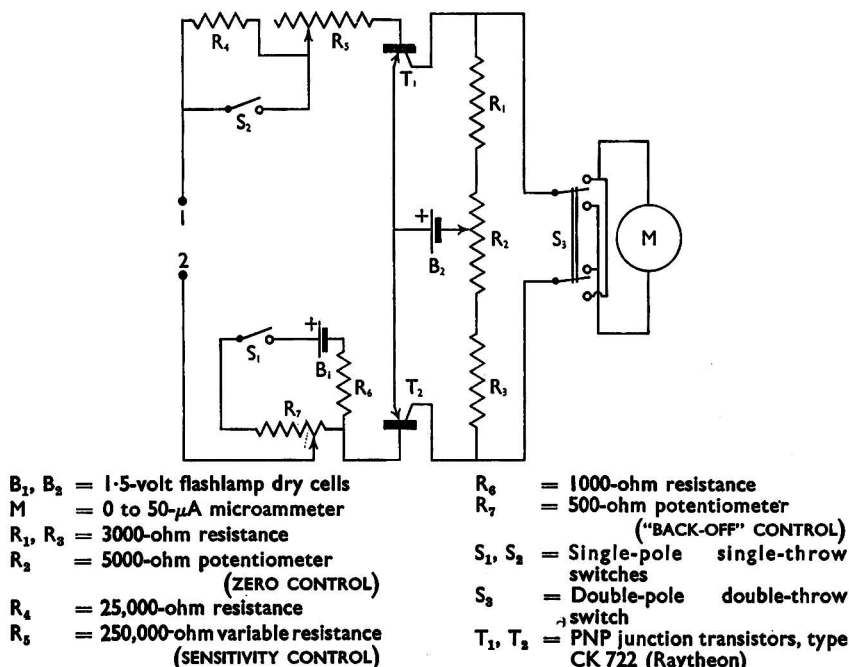

Fig. 1. Circuit diagram of titrimeter

Transistor characteristics are markedly dependent on temperature. Two transistors are therefore used in a balanced type of circuit, the basic principles of which are discussed by Starke.¹ Other transistor amplifiers of balanced^{2,3} and unbalanced^{4,5} types have been described. The $4\frac{1}{2}$ -inch square 0 to 50- μ A microammeter forms the front of the roughly cubical box that houses the entire unit and the two flashlamp cells required for energising the circuit. Current drain is very small, so that the cells last for 6 months or more.

Operation for normal titrimetry is as follows. Set R_5 to give the desired sensitivity, close S_1 and open S_2 . Bring the meter reading to or near zero by adjustment of R_2 . Connect the potentiometric titration system so that the positive electrode goes to terminal 2 and, by adjustment of R_7 , restore the meter reading to zero. Proceed with the titration; if the meter reading falls instead of rising, reverse by means of S_3 .

In differential titrimetry⁶ the e.m.f. of the electrode system is repeatedly brought to zero, so that no "backing-off" voltage is required. For this technique, open both S_1 and S_2 , operate at high sensitivity and, after connecting to the electrode system, bring the meter reading to zero by means of R_2 .

For "dead-stop end-point" titrimetry,^{7,8,9,10} close both S_1 and S_2 , operate at high sensitivity and obtain the desired polarising voltage by adjustment of R_7 .

This apparatus was developed with the partial support of the U.S. Atomic Energy Commission.

REFERENCES

1. Starke, H. F., "Transistor Applications," Raytheon Manufacturing Co., Newton, Mass., U.S.A., p. 19.
2. Phillips, J. P., *Chemist-Analyst*, 1955, **44**, 80.
3. Wieme, R. J., *Bull. Soc. Chim. Biol.*, 1956, **38**, 801.
4. Perryman, P. W., and Richards, D. H., *J. Clin. Path.*, 1956, **9**, 273.
5. Phillips, J. P., *Chemist-Analyst*, 1956, **45**, 107.
6. MacInnes, D. A., and Jones, P. T., *J. Amer. Chem. Soc.*, 1926, **48**, 2831.
7. Foulk, C. W., and Bawden, A. T., *Ibid.*, 1926, **48**, 2044.
8. Stock, J. T., *Metallurgia*, 1948, **37**, 220.
9. —, *Ibid.*, 1952, **46**, 209.
10. —, *Ibid.*, 1957, **55**, 48.

DEPARTMENT OF CHEMISTRY
UNIVERSITY OF CONNECTICUT
STORRS, CONNECTICUT, U.S.A.

JOHN T. STOCK
Received June 27th, 1957

A SUCTION-OPERATED DIFFERENTIAL ELECTRODE SYSTEM FOR POTENTIOMETRIC TITRATION

SINCE the introduction of the differential potentiometric electrode system by MacInnes and Jones,¹ various modifications have been described.^{2,3,4,5,6} Developed in a programme of studies on non-aqueous titrimetry, the suction-operated micro-assembly shown in Fig. 1 is easily constructed.

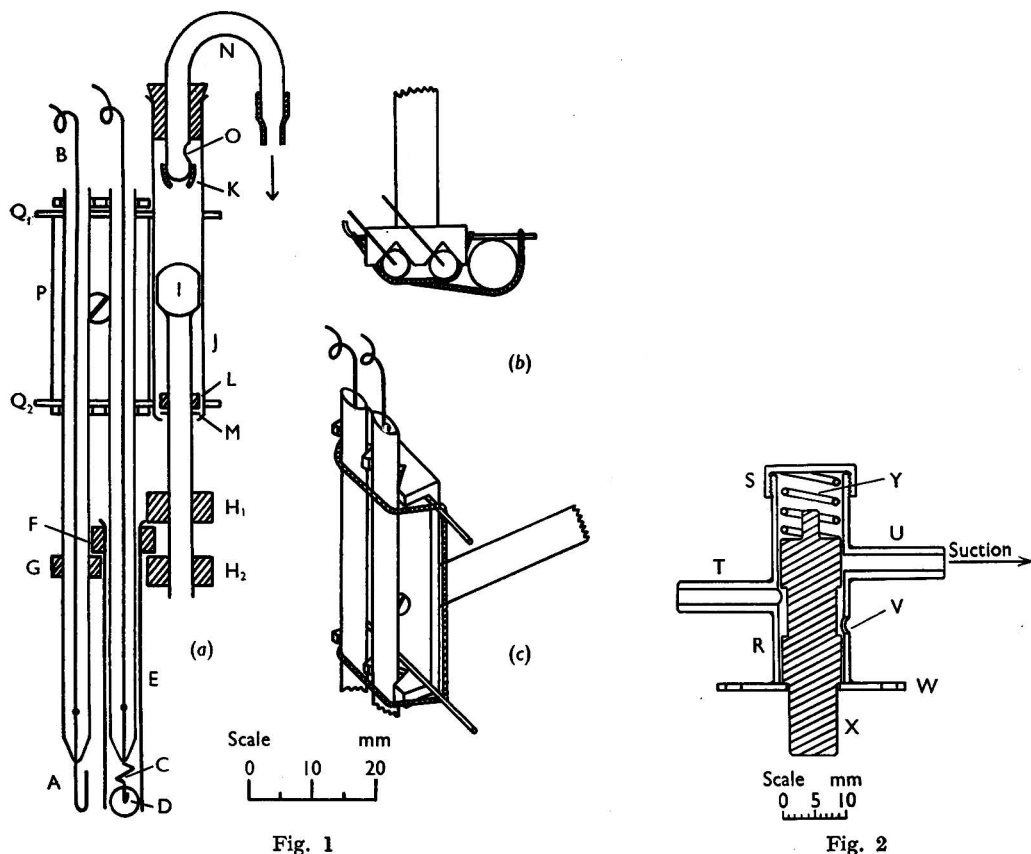

Fig. 1. Differential electrode system: (a), front view (sectional); (b), diagrammatic top view; (c), method of retaining electrode tubes

Fig. 2. Push-button suction control valve

"Exposed" electrode A is a 20-mm length of No. 26-gauge platinum wire and has a light flexible copper connecting lead, B, soldered to one end. With 10 mm projecting, the platinum wire is sealed through one end of a length of glass tubing having an external diameter of 4 mm and

the projecting end is bent hairpin-fashion, as shown. Construction of the "retarded" electrode, C, is similar, but the wire is bent zig-zag and has a 4-mm diameter glass sphere, D, fused on the extremity. The sleeve of glass tubing, E, is about 0.2 mm larger in bore than the diameter of the sphere and slides freely on the electrode tube. To prevent the creeping of solution between electrode tube and sleeve, the glass parts are lightly coated with silicone grease and then wiped with a dry cloth. The collar of rubber tubing, F, rests on a similar collar, G, and prevents the sleeve from falling off during adjustments. The raising of the sleeve allows the approximately 0.1 ml of solution trapped around electrode C to be stirred into the bulk of the solution.

Collars of rubber tubing, H₁ and H₂, on the stem of piston I engage collar F and control the rise and fall of the sleeve. The piston is made from glass tubing having an external diameter of 4 mm by blowing on one end a thick-walled bulb about 9 mm in diameter. With use of fine carborundum paste, the piston is ground into cylinder J, which is a 10-mm diameter micro test-tube with a 4.5-mm diameter hole blown centrally through the bottom. This hole forms a guide for the piston stem.⁷ The piston should slide freely in the cylinder, the travel being limited by collars of rubber tubing, K and L. To prevent its sticking to the bottom of the cylinder, collar L rests upon a copper foil washer, M, while K projects slightly from the closed end of suction tube N. The wall of the latter has a 3-mm diameter hole, O, through which air may be withdrawn from the cylinder. The piston then rises and carries the electrode sleeve with it.

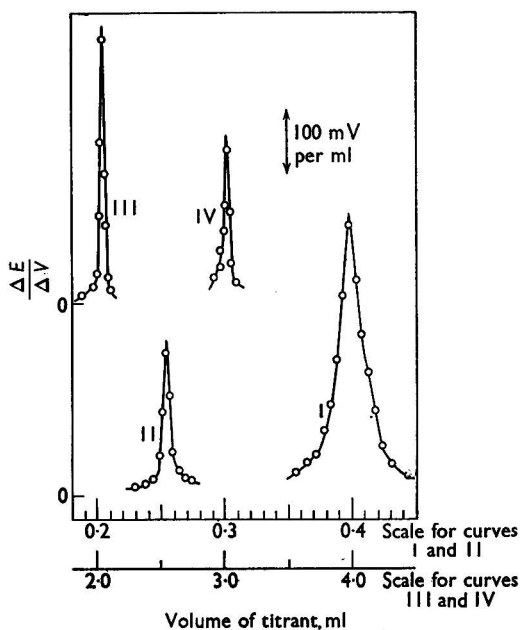

Fig. 3. Differential titrations: curve I, 2.0 ml of 0.002 *N* hydrochloric acid with 0.01 *N* sodium hydroxide; curve II, 2.55 ml of 0.1 *N* acetic acid with *N* sodium hydroxide; curve III, 2.0 ml of 0.1 *N* sodium acetate with 0.098 *N* perchloric acid, both in glacial acetic acid solution; curve IV, 3.0 ml of 0.1 *N* antimony trichloride with 0.1 *N* bromine, both in glacial acetic acid solution

Electrodes and cylinder are held by rubber bands stretched over electrode holder, P, a development of an earlier design,⁵ which allows the whole assembly to be mounted on a ring stand. Lengths of 1-mm diameter brass wire, Q₁ and Q₂, are soldered into each of the right-angle bends of the holder. As shown in the diagrammatic top view Fig. 1 (b), the right-hand side of the holder and the wires projecting from this side locate cylinder J parallel to the electrode tubes. Before the cylinder is mounted, the rubber band that secures the electrode tubes in the V-notches is stretched over the wires as shown in Fig. 1 (c). This form of mounting provides firm support, eliminates risk of breakage and allows easy adjustment or replacement of the various components. For semi-permanent assembly, a few drops of Durofix or similar universal cement will reinforce the grip provided by the rubber bands.

Gentle suction from a filter-pump or vacuum line is ample for operation. A simple control is a short length of glass tubing with a hole blown midway in the wall. This is inserted in the suction line and, when the hole is closed with the forefinger, the electrode sleeve lifts. More convenient is the brass push-button valve shown in section in Fig. 2. Cylinder R carries screwed cap S at one end and has three 3-mm diameter holes drilled through the wall as shown. Over two of these holes are soldered side-tubes T and U, respectively, while the third, V, is open to the atmosphere. A suitably drilled circular plate, W, is symmetrically soldered to the other end of the cylinder. This plate allows the control valve to be panel-mounted and also acts as a stop for the outward movement of piston X, which is a sliding fit in the cylinder and is forced outwards by spring Y. The electrode sleeve lifter, which is connected to side-tube T, is then at atmospheric pressure. When X is depressed, suction is applied to the lifter by way of the annular groove in the piston.

Titration is performed in the usual way,^{1,5} preferably with a concentrated reagent, the electrodes being set just under the surface of the liquid in the titration vessel. In experiments in which appreciable rise of level in the titration vessel occurs, the immersion should be re-adjusted just before the expected end-point.

The device is applicable to a variety of acid-base, oxidation-reduction and precipitation titrations. When a 15-mm diameter micro-beaker with suitable magnetic stirring is used,⁸ volumes as small as 2 ml can be titrated. Curves I and II, Fig. 3, are typical; in these experiments the acid solutions were saturated with quinhydrone.

Using the chloranil-tetrachlorohydroquinone redox system, Kirmann and Daune-Dubois have reported the differential macro-titration of organic acids in dimethylformamide solution.⁹ The titrant was, however, aqueous alkali. Curves III and IV, Fig. 3, refer to titrations in glacial acetic acid, the titrant being made up in the same solvent. These indicate the possibilities of differential titrimetry in non-aqueous systems. The additives were an equimolar mixture of chloranil and tetrachlorohydroquinone for curve III and anhydrous sodium acetate¹⁰ for curve IV.

This work was carried out with the partial support of the U.S. Atomic Energy Commission.

REFERENCES

1. MacInnes, D. A., and Jones, P. T., *J. Amer. Chem. Soc.*, 1926, **48**, 2831.
2. Hall, N. F., Jensen, M. A., and Baekström, S. A., *Ibid.*, 1928, **50**, 2217.
3. MacInnes, D. A., "The Principles of Electrochemistry," Reinhold Publishing Corporation, New York, 1939, p. 306.
4. Kirk, P. L., "Quantitative Ultramicroanalysis," John Wiley & Sons Inc., New York, 1950, p. 47.
5. Stock, J. T., *Chem. Age*, 1954, **71**, 719.
6. Dole, V. P., and Thorn, N. A., *Anal. Chem.*, 1955, **27**, 1184.
7. Stock, J. T., and Fill, M. A., *Analyst*, 1946, **71**, 536.
8. —, —, *Mikrochim. Acta*, 1953, **1**, 89.
9. Kirmann, A., and Daune-Dubois, N., *Compt. Rend.*, 1953, **236**, 1361.
10. Tomiček, O., and Heyrovský, A., *Coll. Czech. Chem. Comm.*, 1951, **15**, 997.

DEPARTMENT OF CHEMISTRY
UNIVERSITY OF CONNECTICUT
STORRS, CONNECTICUT, U.S.A.

JOHN T. STOCK
Received July 12th, 1957

British Standards Institution

NEW SPECIFICATIONS*

- B.S. 988:1957. Mastic Asphalt for Roofing (Limestone Aggregate). Price 4s. 6d.
B.S. 1170:1957. Treatment of Water for Marine Boilers. Price 12s. 6d.

AMENDMENT SLIPS*

PRINTED slips bearing amendments have been issued by the Institution, as follows—

- PD 2888—Amendment No. 2 (September, 1957) to B.S. 1848:1952. Glass Condensers.
PD 2907—Amendment No. 2 (October, 1957) to B.S. 593:1954. Laboratory Thermometers.

* Obtainable from the British Standards Institution, Sales Department, 2 Park Street, London, W.1.

Book Reviews

MICRO-ANALYSIS IN MEDICAL BIOCHEMISTRY. By E. J. KING, M.A., Ph.D., D.Sc., F.R.I.C., and I. D. P. WOOTTON, Ph.D., M.A., M.B., B.Chir., F.R.I.C. Third Edition. Pp. xii + 292. London: J. & A. Churchill Ltd. 1956. Price 22s. 6d.

Since the publication of the first edition in 1946, Professor King's "Micro-Analysis in Medical Biochemistry" has been an essential item in almost every hospital biochemical laboratory in the

country. Translations into Spanish, Italian and Serbo-Croat show that it is rapidly becoming essential in many laboratories of other countries as well. It sets out to describe clearly and concisely the routine methods of biochemical analysis used in the Department of Chemical Pathology at the British Postgraduate Medical School. Since the accuracy and adequacy of these methods have been fully checked before they are acceptable for the routine work at Hammersmith, and since they were employed there for a long time before they were described in this book, it is axiomatic that they may be accepted by laboratories in which the opportunities of checking them are limited.

The present edition, of which Dr. I. D. P. Wootton is now a co-editor, will enhance the reputation enjoyed by the previous editions. An increase in the number of pages from 222 to 292 has been brought about by the introduction of a number of new procedures, including the estimation of uric acid by uricase, phosphatase by the determination of liberated phenol with aminoantipyrine, of lead and mercury in urine and faeces, as well as the ethylenediaminetetra-acetate determination of calcium, the paper chromatography of urinary sugars and the vitamin-A absorption test. It is a tribute to the high quality of the methods described in the previous editions that the only section that has required to be extensively revised in the present edition has been that on colorimetric and spectrophotometric analyses. Quite rightly, the authors have decided to omit all consideration of the simple visual colorimeter in order to permit expansion of the section on spectrophotometry to 20 pages. This is an excellent section and not only includes a discussion of the principles of spectrophotometry and of particular instruments, but also gives full practical details of estimating blood oxygen saturation, carboxyhaemoglobin concentrations and blood barbiturates. The revolution in the estimations of electrolytes brought about by the introduction of flame photometry has made necessary increasing the section on this subject from three-quarters of a page to a total of 5 pages. It is surprising therefore to find that colorimetric methods of estimating sodium and potassium are still included. These techniques are so time-consuming that the flame photometer should be available in every department expected to estimate electrolytes; otherwise the patient all too often is dead before the result of the analysis is available. The practical details of carrying out balance experiments will be especially appreciated by those to whom such investigations are not a daily routine.

In a short book review, criticism is apt to over-emphasise the bad features of a book, but the following minor criticisms are not intended to detract in any way from the opinion that this is a most excellent manual. It is the reviewer's personal view that serum bilirubin is better estimated with a technique that avoids absorption of pigment on the precipitated plasma proteins. The introduction of tablet tests for many of the qualitative investigations of urine is sufficiently well established to require mention, whereas the fermentation and osazone methods of identifying reducing substances are unlikely to be employed when paper chromatography is available. The glucose-oxidase enzyme tests have probably been reported too recently to be ready for the manuscript at the time the book was being prepared. It is surprising that, although there is a reference to the estimation of 17-ketogenic steroids in urine, this is not described in detail. This procedure is now widely used in the assessment of adrenal function in clinical patients. In the section on the urea clearance test, five examples of the calculation seems rather excessive; two would have sufficed and the space saved could have been used to explain more clearly the concept of the standard clearance.

Tables of logarithms, of international atomic weights and of solubilities of common compounds in water add to the value of this useful manual. Although it is not a critical compendium of methods in the sense of the original volume by Peters and van Slyke, it is nevertheless not a mere cookery book of methods. Every hospital biochemist and all others concerned with the analysis of biological material will consider it excellent value at the modest price of 22s. 6d.

C. H. GRAY

THE CHEMISTRY OF THE COORDINATION COMPOUNDS. Edited by JOHN C. BAILAR, JUN. Pp. x + 834. *American Chemical Society Monograph No. 131.* New York: Reinhold Publishing Corporation; London: Chapman & Hall Ltd. 1956. Price \$18.50; 148s.

Professor J. C. Bailar, jun., originally intended to write this book alone, but the literature on co-ordination compounds is so vast that he decided to ask twenty-three of his students and former students to help him.

No attempt has been made to cover the chemistry of co-ordination compounds completely, but an effort has been made to select ideas that are fundamental and stimulating. This is not a

practical book, although there are chapters on subjects such as co-ordination compounds in electro-deposition and the use of co-ordination compounds in analytical chemistry.

A considerable effort has been expended in systematising knowledge of co-ordination compounds, but a student will not find in this volume a logical introduction to co-ordination chemistry. For example, the book starts with a general survey of the chemistry of numerous compounds, but the meaning of co-ordination is not discussed in any detail until Chapter 2 (p. 100) on the early development of co-ordination theory is reached. Moreover, it is a pity that Chapter 3 (the electrostatic theory) and Chapter 4 (the electron pair bond) were not interchanged, because the section on the electron pair bond gives the approach that is generally associated with co-ordination theory.

The chapters dealing with structure are useful critical reviews that should be valuable to research workers. No doubt the story on p. 189 of the theorist who advanced a beautiful explanation for a fact that he had misread has a moral.

The account of the analytical uses of co-ordination compounds occupies only twenty-six pages, so that each item has little space; thus rubeanic acid is merely mentioned by name and is dismissed with a short list of references.

The text is remarkably free from errors, although it is unfortunate that no co-ordination has been achieved between the two parts of Mr. Trotman-Dickenson's name (see p. 224). The conventional method of writing the substances on the right-hand side of an equation in the numerator of the equilibrium constant has not been employed on p. 572 and p. 591, although the normal convention has been used elsewhere in the book. The relationship between the diagram showing connected circles on p. 31 and the structure of the compound $(C_2H_5)_4Au_2SO_4$ is not understandable without consulting the original paper.

The book binding does not appear to be strong enough to hold together this $3\frac{1}{4}$ -lb tome, for the covers had already started to break away from the texts in two copies that were examined.

An undergraduate will probably find this work too detailed and too expensive and an analyst will find that this book does not contain enough experimental detail to satisfy his needs, but many a librarian will prize this volume as a valuable survey of certain aspects of co-ordination chemistry.

E. F. G. HERINGTON

AMINO ACID HANDBOOK: METHODS AND RESULTS OF PROTEIN ANALYSIS. By RICHARD J. BLOCK, Ph.D., and KATHRYN W. WEISS, A. B., and others. Pp. xiv + 386. Springfield, Illinois: Charles C. Thomas; Oxford: Blackwell Scientific Publications. 1956. Price 80s.

HUMAN PROTEIN REQUIREMENTS AND THEIR FULFILMENT IN PRACTICE. Proceedings of a Conference in Princeton, United States (1955), sponsored jointly by The Food and Agriculture Organisation of The United Nations (F.A.O.), The World Health Organisation (W.H.O.) and the Josiah Macy Jr. Foundation, New York. Edited by J. C. WATERLOW and JOAN M. L. STEPHEN. Pp. 194. Rome: F.A.O.; Geneva: W.H.O. 1957. Price 10s.

The second part of "Amino Acid Handbook," though it consists entirely of tables (95 pages of them), may well be the most permanently valuable to the analyst. It is certainly an up to date and comprehensive account of its subject—called by the authors "The Amino Acid Composition of Proteins" and constituting Part B of the volume. There does not seem to be any Part A, but this is presumably to be understood as the first 245 pages, including 67 pages of bibliography and called "Methods and Results of Protein Analysis."

The usefulness of the figures tabulated in Part B must be wholly dependent on the validity of the methods described earlier in the book. The particular method used to establish any one figure is to be found—at least I hope so—via the reference given alongside the figure in the Tables. Then it is for the analyst to apply his critical judgment to the question how accurate, and how precise, is any figure required by him and taken from the Tables.

Certainly he has plenty of material on which to exercise that judgment. The methods described include both chemical and microbiological (in chapters III and IV, respectively), after an introductory chapter and, sensibly enough, a chapter (II) on "Preparation of the Sample for Analysis." This includes a short account of the Kjeldahl method—in its "macro" as well as "micro" and "rapid" modifications—the authors having given at the beginning of the chapter their reasons for thinking that the determination of "protein content (nitrogen \times 6.25)" is an essential preliminary to amino-acid analysis. But I can find no discussion of whether the factor 6.25 is invariably applicable. The same chapter also describes the method of preparing and "purifying" amino-acid solutions, including the fashionable modern de-salting procedure on ion-exchange resins; curiously enough, this stage is described before the method for hydrolysing the protein to be analysed.

After the chapters on microbiological and chemical methods comes one on paper chromatography and another on column chromatography of amino-acid mixtures in solution. It is gratifying—for more reasons than one—to note frequent references to British workers in this and other fields covered by the book, though it is a little odd to find no mention whatever of Gale (even in the index) or consequently of the fact that he has incidentally invented a new method of amino-acid analysis by the use of the amino acid decarboxylases. Why no one has developed and applied this method, which is at least in theory by far the most specific available, is hard to understand.

The modification of microbiological assay procedures so as to use Petri dishes or "large plates" and to measure "zones of exhibition" rather than turbidity or acid production, so successfully applied in this country to routine vitamin determinations, appears, from the lack of any mention in this book, never to have been tried on amino acids. Perhaps this is because so far their measurement has almost always been a research job and no "fordising" of procedure for control purposes has been called for.

These circumstances will assuredly change. The time must come—and sooner perhaps than many expect—when food manufacturers and others will no longer to any useful purpose standardise, or even control, their products for content of "protein," that is, of nitrogen $\times 6.25$. In the report just published jointly by F.A.O. and W.H.O. entitled "Human Protein Requirements and their Fulfilment in Practice," there is given a full account of the Conference held at Princeton in 1955 (it is nowhere disclosed in the book exactly when in 1955 it took place, though internal evidence indicates that it must have been near the beginning of the year). This book has been so well edited and put together in so realistic a manner that to read it continuously—and at one sitting—is a pleasure and conveys a strong sense of active participation. The report makes abundantly clear how the minds of experts—physiologists, biochemists, nutritionists, paediatricians, epidemiologists, pathologists—are turning from consideration of proteins to consideration of their constituent amino acids, that is, to the nature, quantity and properties of each individual amino acid, and to their interactions. Even though the promised forthcoming report of the meeting held later in 1955 by the F.A.O. Committee on Protein Requirements can hardly carry us much further, it is bound to speed the day when none of these experts will accept as having much value any statement about the "total protein" content of a food or a diet. The demand will then be at least for a statement of individual amino-acid percentage as of individual vitamins and individual mineral elements.

The food analyst, in local or national government service, in hospital laboratory or in industry, will have to answer the challenge implicit in such demands. That he will then be able to do so will in no small measure be due to the pioneer work of Professor Block and his colleagues. Always outstanding among their contributions will be the compilation, arrangement and presentation of the material in this book to end—for the present anyhow—all other books on the subject.

A. L. BACHARACH

A GUIDE TO QUALITATIVE ORGANIC CHEMICAL ANALYSIS. By R. P. LINSTAD, C.B.E., D.Sc., D.I.C., F.R.I.C., F.R.S., and B. C. L. WEEDON, D.Sc., Ph.D., A.R.C.S., D.I.C., F.R.I.C. Pp. xii + 169. London: Butterworths Scientific Publications; New York: Academic Press Inc. 1956. Price 21s.; \$4.50.

This book, based on a manual of instruction evolved at Imperial College during the years since 1930, bears all the marks of the work of practised teachers. Written for students preparing for their first degree and for the Graduateship of the Royal Institute of Chemistry, the book, although essentially an instructional book, is at the same time refreshing and readable.

The scheme of analysis described in the first 100 pages of the book is no simplified routine process devoid of educational value, but a sound approach to the subject of qualitative organic analysis. Although restricted to the requirements of the undergraduate, the training offered in dealing with the twenty-three functional groups covered by the book provides a sound basis for the analysis of more complex compounds.

The details given of the experiments described in this Guide are clear and precise. The preparations can rightly be called "small scale," but it is to be regretted that the Authors have nowhere given a description of the size or design of the apparatus required. The quantities prescribed for many of the test-tube experiments are often of the order of 5 ml—these could with advantage be adjusted to a total volume of 3 to 4 ml, thereby allowing the use of a 3-inch \times $\frac{3}{8}$ -inch or "semi-micro" test-tube.

In any work dealing with the analysis of organic compounds a list of melting-points is essential and the last 50 pages are occupied by 27 tables giving melting-points of derivatives of some 800

simple organic compounds. Here it would be helpful if some indication could also be given of the most suitable derivative to be prepared in each instance.

The book is well produced and, for a first edition, remarkably free of printer's errors. The authors are to be congratulated on a fine piece of work, which teachers in Universities and Technical Colleges would do well to examine.

H. HOLNESS

SUPPLEMENT TO MELLOR'S COMPREHENSIVE TREATISE ON INORGANIC AND THEORETICAL CHEMISTRY.

Supplement II. Part I—F, Cl, Br, I, At. Editorial Board: H. V. A. BRISCOE, D.Sc., A.R.C.S., D.I.C., F.R.I.C., A. A. ELDRIDGE, B.Sc., F.R.I.C., and G. M. DYSON, M.A., D.Sc., F.R.I.C., M.I.Chem.E., F.Inst.Pet. Pp. liii + 1153. London, New York and Toronto: Longmans, Green & Co. Ltd. 1956. Price 170s.

"Mellor" has long been out of date; the first volume appeared in 1922 and the last in 1937. Yet throughout the years it has retained with distinction its place on our library shelves with "Beilstein." Now, like "Beilstein," it is to have its supplementary volumes and they will be welcomed warmly if they are all of the high quality of the first.

The Editorial Board and the Publishers have most wisely decided not to have the whole work re-written. The supplements are intended to be used with the original volumes and are arranged similarly. The many contributors to this work on the halogens are experts in their fields and have produced most valuable surveys with copious references.

Many subjects entirely new to the main edition are included. Radiochemistry, embracing fission isotopes, radiation chemistry and excited-atom chemistry, occupies nearly 200 pages, spectro-chemistry and photo-chemistry are fully surveyed, and a good account of modern fluorine chemistry, including the fluorocarbons, is given. Astatine, the 10-year-old member of the halogen family, is well discussed in a section of fifteen pages.

Very good summaries of analytical methods are given, with references to original papers, and adequate notes upon the biological importance of the halogens and their compounds are provided.

The contributors and publishers have produced an excellent reference work, which will be an essential in every chemical library. No reference has been found in this book (dated 1956) later than 1953; it is thus already 3 years out of date. However, reassurances can be taken from the aim of the Editors, which is declared in the preface: "to produce the series of Supplements as quickly as possible and at relatively low cost so that it might be possible in the future as in the past for the individual chemist himself to possess the Volumes dealing with fields of inorganic chemistry in which he was especially interested."

A. J. LINDSEY

VITAMIN A. By THOMAS MOORE, Sc.D., D.Sc. Pp. xx + 645. Amsterdam: Elsevier Publishing Co.; London: Cleaver-Hume Press Ltd.; New York: D. Van Nostrand Co. Inc. 1957. Price 76s.; \$14.00.

The amount of published work on vitamins is now very large, and this substantial volume deals only with the provitamins and vitamins A. It is interesting to note that even so the author has been able to cover the ground only by dint of careful selection. Dr. Moore has been engaged in research on vitamins A and E and in other nutritional matters for 30 years and has himself made noteworthy contributions to knowledge. He is therefore well equipped to survey the subject of vitamin A, and in doing so is willing to "be guided by the incomplete pattern which research has actually followed."

Part I of the book consists of an interesting historical introduction and Part II is devoted to the estimation of vitamins A and provitamins A by biological assays and by colour reactions, fluorescence and spectro-photometry. Part III deals with the chemistry of vitamin A and its provitamins and congeners. Part IV is concerned with the comparative biochemistry and natural history of the carotenoids and vitamin A.

Parts V, VI and VII are outstanding. Beginning with absorption of provitamins A, the argument proceeds via the conversion of provitamins to vitamin A to the absorption of vitamin A itself. The next step is the storage, distribution and mobilisation of vitamin A; this leads to requirements and then to transfer of vitamin A from mother to offspring. Then comes a section on vitamin A and vision, and from this follows a discussion of both *cis-trans* isomerism and vitamin A₂. The pathology of vitamin-A deficiency is then fully described, and hyper- vitaminosis A is reviewed carefully. A long section is then given over to vitamin A in human health and disease. Part VIII surveys the state of knowledge about vitamin A in farm and domestic animals; there are two good chapters on vitamin A and sex, and another on vitamin A and the thyroid. The final chapter is a shrewd assessment of our present knowledge of vitamin A.

In the preface Dr. Moore says—

“At the same time we must, to some extent, condense our account of the crowded and fashionable fields of investigation, and deal more expansively with topics which have been less popular than their importance would have justified.”

In tracing the historical development of knowledge about vitamin A it may be seen that the second great phase turned on estimation—the development of biological and spectrophotometric methods. From this came criteria of purity, isolation, characterisation and, eventually, elegant syntheses to close a great chapter. The third phase was the elucidation of the chemistry and biochemistry of vitamin A in relation to vision. The fourth and by far the most incomplete phase is the clarification of the biochemistry of vitamin A, its modes of action in tissues generally. The second and third phases have gone far enough to be presented in a tidy and concise fashion at the cost of some over-simplification. The new generation of research workers faces difficult problems in the fourth phase; as an unrivalled guide here, Dr. Moore is definite when the facts are clear and is scrupulously fair to all hypotheses that may or may not be valid.

R. A. MORTON

ORGANIC ANALYSIS. Volume III. Edited by J. MITCHELL, jun., I. M. KOLTHOFF, E. S. PROSKAUER and A. WEISSBERGER. Pp. viii + 546. New York and London: Interscience Publishers Inc. 1956. Price \$11.50; 92s.

This third volume of the series is half as large again as the previous member (*Analyst*, 1956, 81, 676), and the number of review articles is reduced to six. Instrumental methods as such are represented by the analytical applications of the mass spectrometer (56 pp.); the opportunity to operate such expensive equipment is given to few, but this chapter should serve to illustrate its capabilities to the many.

The first four chapters describe analytical methods for various functional groups: organic acids (96 pp.); acid anhydrides (32 pp.); amines and amides, with some brief notes on imides, imines and quaternary ammonium compounds (74 pp.); olefinic unsaturation (184 pp). Chemical, physical and instrumental methods are described; among the newer procedures covered are gas chromatography for acids and olefinic substances, ion exchange for the former and non-aqueous titration for acids and amines. The article on olefinic unsaturation—which, from its title, will be understood as not being limited to hydrocarbons—is a remarkable achievement, presenting in condensed form no less than just under seven hundred papers.

The last chapter breaks new ground in this whole series by dealing with applied analysis; the subject is synthetic organic coating resins, to which the author has felt it necessary to add a sub-title indicating the necessity to limit his field to “some commercially important classes.” This branch of technology is one in which there have been great advances, particularly during the last 20 years, resulting in the appearance of some complex analytical problems. To say that this article will prove of particular value to the analyst faced with an occasional sample is not to deny its general worth.

A few corrections for volume II are given; the index is cumulative, though in less detail for the two earlier volumes.

B. A. ELLIS

Publications Received

THE CHEMISTRY OF THE ACTINIDE ELEMENTS. By JOSEPH J. KATZ and GLENN T. SEABORG. Pp. xvi + 508. London: Methuen & Co. Ltd.; New York: John Wiley & Sons Inc. 1957. Price 63s.

REPORTS ON THE PROGRESS OF APPLIED CHEMISTRY. Volume XLI: 1956. Editor: H. S. ROOKE, M.Sc., F.R.I.C. Pp. 795. London: The Society of Chemical Industry. 1957. Price 100s.

YEASTS. By K. ARIMA, W. J. NICKERSON, M. PYKE, H. SCHANDLER, A. S. SCHULTZ, A. C. THAYSEN and R. S. W. THORNE. Edited by W. ROMAN. Pp. 246. The Hague: Dr. W. Junk, Publishers. 1957. Price 25 Guilders.

PRESSURE MEASUREMENT IN VACUUM SYSTEMS. By J. H. LECK, M.Eng., A.M.I.E.E., A.Ins.P. Pp. 144. London: Chapman & Hall Ltd. on behalf of the Institute of Physics. 1957. Price 30s.

A publication in the Physics in Industry Series.

VOLUMETRIC ANALYSIS. VOLUME III. TITRATION METHODS: OXIDATION-REDUCTION REACTIONS. By I. M. KOLTHOFF and R. BELCHER. With the co-operation of V. A. STENGER and G. MATSUYAMA. Pp. x + 714. New York and London: Interscience Publishers Inc. 1957. Price \$15.00; 115s.

CLASSIFIED ADVERTISEMENTS

The rate for classified advertisements is 5s. a line (or space equivalent of a line), with an extra charge of 1s. for the use of a Box Number. Semi-displayed classified advertisements are 60s. per single-column inch.

ANALYST back volumes and sets wanted to buy for cash. Also other scientific journals. Write to A. Ashley, 27, East 21 St., New York, 10, N.Y., U.S.A.

THE GENERAL ELECTRIC COMPANY
LIMITED, WITTON, BIRMINGHAM, 6

AN ANALYTICAL CHEMIST, who prefers a variety of interesting work rather than specialising in a particular field or carrying out routine procedures, is required for problems connected with the chemistry of materials used in electrical engineering. The position is a responsible one and calls for adaptability and inventiveness.

Applicants should possess a degree or A.R.I.C. and have some analytical experience. Applications giving details of age, qualifications and experience should be sent to the Staff Manager, General Electric Co. Ltd., Witton, Birmingham, 6.

ANALYTICAL CHEMIST (male or female) required by Manufacturing Chemists for their Watford factory. Industrial and Pharmaceutical experience essential. Five-day week. Pension scheme. Apply in writing to Box No. 3959, The Analyst, 47, Gresham Street, London, E.C.2.

UNILEVER LIMITED have a vacancy for an Analytical Chemist in their Food Research Laboratory situated in a country estate near Bedford. Candidates should hold a good Honours degree, or its equivalent, in Chemistry and have had at least five years' post-graduate experience, preferably in the analysis of foods and/or agricultural products and feeding-stuffs. A progressive salary will be paid depending on age and experience. Successful candidate will be eligible for membership of the company's superannuation fund and widow's pension scheme. Please apply to:—The Staff Officer (Ref. IDM.6), Unilever Limited, Food Research Department, Colworth House, Sharnbrook, Bedford.

CHEMIST. May & Baker Ltd., Dagenham, Essex, have a vacancy for a graduate Chemist in their Analytical Development Laboratory to develop chemical and physico-chemical methods of analysis. Applicants with experience in analysis are preferred but recently qualified graduates will be considered. An interest in this type of work and high standard of practical competence are essential. Five-day week. There is a Pension Fund and Life Assurance Scheme in operation. Apply initially in writing to the Personnel Officer, quoting Reference No. 197.

SENIOR ASSISTANT required by Public Analyst (London, S.E.1), H.N.C. or degree standard, with experience in food analysis. Salary scale within range £650-£900 according to qualifications and experience. Write with details to Box No. 3960, The Analyst, 47 Gresham St., London, E.C.2.

CHEMISTS. Opportunities are available at the Metallurgical Department of The Steel Company of Wales Ltd., for Chemists on day and shift work. Adequate experience with lesser qualifications or National Certificate in Chemistry will be favourably considered. Applicants should have some experience of routine analysis of iron and steel and should have completed their National Service. The plant is on the South Wales seaboard in spacious and pleasant surroundings where residential areas are expanding. Working conditions, salaries and prospects are excellent. Those wishing to apply should write giving fullest possible details of age, experience, qualifications and present salary, to:—Superintendent, Personnel Services, THE STEEL COMPANY OF WALES LTD. (STEEL DIVISION), Abbey Works, PORT TALBOT, Glam.

CIVIL SERVICE COMMISSION, DUBLIN

vacancy for

CHIEF TECHNICAL OFFICER AT THE BUTTER-
TESTING STATION OF THE DEPARTMENT OF
AGRICULTURE

Salary Scale: Man: £1,220-£1,414; Woman: £1,018-£1,220. Age Limits: 25-45 years. Essential: (a) An Honours University Degree (or equivalent) in Dairy Science or in Science and (b) Experience in the chemical analysis of food and water and training in bacteriology. Application forms and further particulars from the Secretary, Civil Service Commission, 48, Upper O'Connell Street, Dublin. Latest date for receiving completed application forms: 31st January, 1958.

BRITISH INDUSTRIAL PLASTICS LIMITED

B.I.P. Chemicals Ltd., Oldbury, have a vacancy for an Analytical Chemist for a Senior position in a modern works control laboratory. Minimum qualification A.R.I.C. Previous experience organic analysis and works control is desirable, together with ability to control staff. The position offers scope for initiative as early expansion of the work of the laboratory is planned. The company offers good conditions of employment and has a Pension and Life Insurance Scheme. Applications should be made in writing to:

Personnel Manager, B.I.P. Chemicals Ltd., Oldbury, Birmingham.

CHIEF CHEMIST

A GRADUATE CHEMIST (age up to 30 years), with several years' experience of trace element analysis, is required in the North Midlands area, to take charge of several new laboratories concerned with the analysis of an important raw material connected with the nuclear power industry. He will be responsible for guiding a team of assistants, and will be given the opportunity to advise on the lay-out and setting up of new laboratories.

This appointment provides a unique opening in this field and offers a four figure salary for this position.

Contributory pension and free life assurance schemes in operation.

Apply, with full details of past experience, education and qualifications, marked Private and Confidential, to Ref. QC/1, Box No. 3958, The Analyst, 47, Gresham Street, London, E.C.2.

SENIOR ANALYST, with food and drugs experience, required by a London Public Analyst. Salary, at appropriate level on the scale £750-£1100 for an A.R.I.C., or, with Branch E, £1300-£1600. Box No. 3957, The Analyst, 47, Gresham Street, E.C.2.

RESEARCH CHEMIST

FERRANTI LIMITED, EDINBURGH,

wish to recruit a chemist (male or female) for their research laboratories. The work includes investigation of new plastic and ceramic materials and problems in metallurgy and analysis. The successful applicant will be a graduate with broad interests in the research field. Previous industrial experience is not essential. A substantial salary will be offered and a staff pension scheme is in operation.

Applications should be addressed to the Personnel Officer,
Ferranti Ltd., Ferry Road, Edinburgh, 5,
quoting Ref. No. R.Ch/174.

small wonder . . .

*The very wide range
of motors include:
A.C./D.C. UNIVERSAL,
SHUNT, SPLIT PHASE,
3-PHASE, CAPACITOR,
SYNCHRONOUS and
SHADED POLE MOTORS:
1/250 h.p. to 1/3 h.p., also
GEARED UNITS 0.125
to 600 r.p.m. with Torque
up to 850 lbs./ins.*

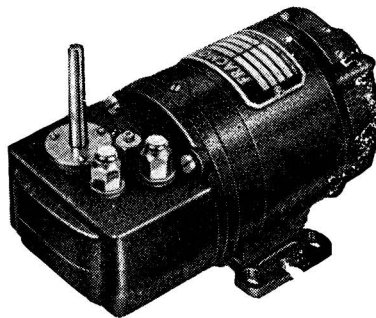

Illus. : Type 334C40
Geared Motor, with
A.C. and D.C. inter-
changeable frames.
1-20 r.p.m. Torque:
20-10 lbs./ins.

FRACMO *does a big job!*

★ Our vast resources and many years of wide and practical experience are available to you. Consult us first—and be sure of success!

FRACTIONAL H.P. MOTORS LTD

Rookery Way · Hendon · N.W.9 · Phone: COLindale 8022/4
Birmingham · 6 Lansdowne Road · Erdington · Birmingham 24 · Phone: Erdington 0460

DaF346



off the ^{top} shelf

service

FOR FINE CHEMICALS,
LABORATORY GLASSWARE,
& TECHNICAL EQUIPMENT
OF ALL KINDS.



BEECROFT & PARTNERS

BEECROFT & PARTNERS (METALLURGISTS) LTD. RETORT WORKS, SCOTLAND STREET, SHEFFIELD 3. Phone 21582

streamlined for speed

Stanton's new
single pan

Ultramatic balances

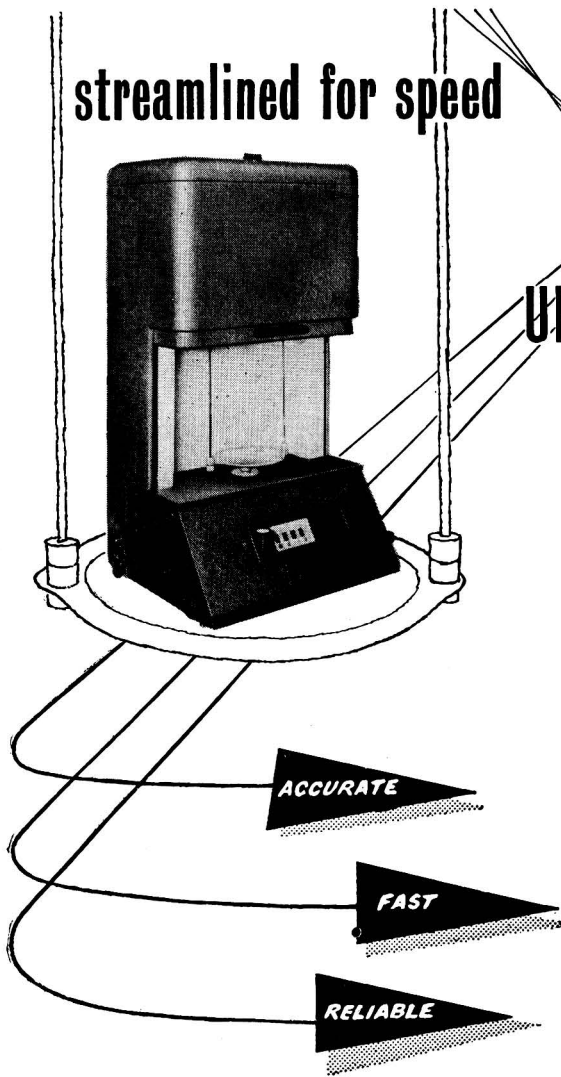

Now in full production, this latest Stanton Achievement has all the good looks and performance of a thoroughbred precision instrument, streamline-built for speed and accuracy.

GREATER EASE OF USE

A large easily accessible pan space—dual release at bench level—counter indicator for weights adjacent to graticule screen at base of balance.

GREATER WEIGHING SPEEDS

Both hands can be used—partial release switch eliminates slow starting—convenient banking of colour marked weight loading dials.

INCOMPARABLE RELIABILITY

Applied load design of proven dependability—fitted with Stanton Synthetic Sapphire (Corundum) Planes—agate arrestment bearings and knife guards—stainless steel weights Class 'A' adjustment.

WE EXHIBIT AT

FRANKFURT AM MAIN
31st MAY—8th JUNE 1958

— And dial weight loading up to 200 grammes

* We shall be glad to send you our illustrated leaflet. Mention Pamphlet A/8

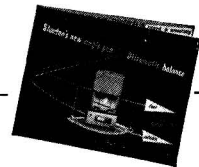

time and labour saving
-THE LAST WORD IN AUTOMATIC WEIGHING

STANTON INSTRUMENTS LIMITED, 119, OXFORD STREET, LONDON, W.1.

MSE**Basket CENTRIFUGES**

for liquid clarification or recovery of solids by continuous action

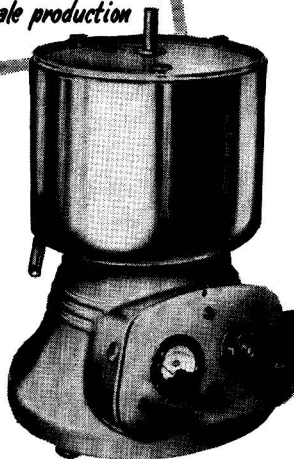
NEW! ideal for small scale production

Model 300 gives an outlet flow rate of 45 gallons per hour and has stepless speed control up to the maximum speed of 4000 r.p.m.

Model 3000 gives maximum flow rate of 150 gallons per hour, and has stepless speed control up to the maximum of 4000 r.p.m., an electric speed indicator and a pilot light. A "Sampling Attachment" is available for this Model, whereby either a sample or a continuous flow can be taken at any intermediate point between the liquid intake and final caking.

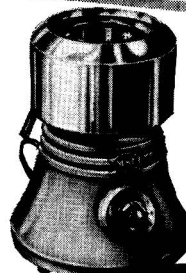
**Model 3000**

3 litres cake capacity

Model 300

300 cc. cake capacity

MEASURING & SCIENTIFIC EQUIPMENT LTD

Spenser Street, London, S.W.1 Telephone: VICTORIA 5426

The NEWER Organic Reagents**Enlarged Series Available:**

- 19 1-(o-Arsonophenylazo)-2-naphthol-3, 6-disulphonic Acid Sodium Salt.
- 384 Benzhydroxamic Acid
- 358 2-Benzimidazolethiol
- 291 3, 5-Diaminobezidine Hydrochloride
- 302 Diantipyrilphenylmethane
- 396 1, 8-Dihydroxy-2-(8-hydroxy-3, 6-disulpho-1-naphthylazo) naphthalene-3, 6-disulphonic acid. Sodium Salt.
- 76 3, 5-Dimethylpyrazole
- 379 2-Hydroxy-1-(2-hydroxy-4-sulpho-1-naphthylazo)-3-naphthoic Acid
- 381 N-Hydroxymethylphthalimide
- 324 2-(o-Hydroxyphenyl)benzoxazole
- 137 Isatin- α -oxime
- 380 Phenylarsenoxide
- 218 n-Propylarsonic Acid
- 298 Resacetophenone oxime
- 237 Salicylidene-o-aminophenylarsonic Acid
- 312 Tetraphenylarsonium chloride Hydrochloride
- 281 2, 4, 7-Trinitrofluorenone

For the detection and estimation of the rarer elements; these reagents consists mainly of the Arsonic acids and their derivatives. They are refined to within stringent limits.

Metallurgists, Analytical Chemists, etc., are encouraged to apply for a full list of Torbet Fine Chemicals, and a collection of monographs on their application to methods of analysis.

TORBET FINE CHEMICALS

24-26 Great King Street
EDINBURGH 3

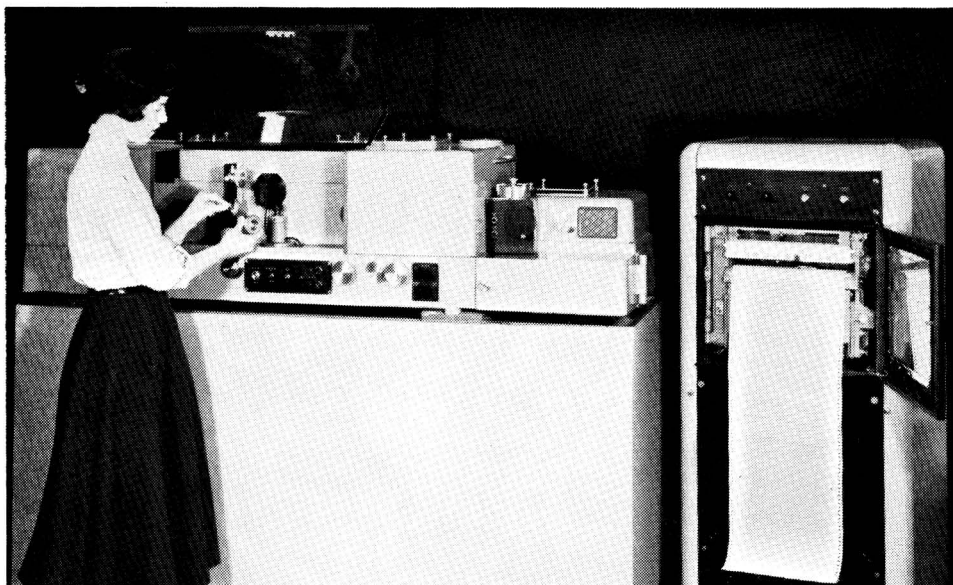

When it's a question of analysis . . .

. . . the quickest and most precise answer is given by the spectrograph and its relations—the spectrophotometer and absorptiometer. Metals, ceramics, glasses, oils, plastics, foodstuffs, vitamins, drugs, chemicals, paints, pigments, dyestuffs . . . whatever the substance, the instrument will analyse it in minutes where the chemist takes hours, in seconds where he takes minutes. This is especially true nowadays, when the instruments are largely, and sometimes entirely, automatic. Spectrochemical analysis guarantees the purity of your product, saves you costly time and labour.

The illustration shows the H 800 double-beam infra-red spectrophotometer, the latest of a long line of commercial infra-red instruments dating back to 1913.

HILGER & WATTS LTD

98 ST PANCRAS WAY, LONDON, NW1

THE MAHLER-COOK EASY-SEAL BOMB CALORIMETER



QUANTITATIVE
ANALYSIS BOMBS



FLUORINE BOMBS



MAGNETIC SEPARATORS



HIGH PRESSURE
AUTOCLAVES



ETC. ETC.



CHAS. W. COOK & SONS LTD
97, WALSALL RD., PERRY BARR
BIRMINGHAM, 22B

THIS IS NO LUCKY DIP!



Johnson Test and Indicator Papers can either be dipped in the solution being examined, or the solution can be applied to the paper drop by drop.

Universal and Comparator Test Papers have a multitude of uses in Science, Industry and Education. They give, quickly economically and easily, accurate indications of pH values from 1 to 10. The papers are bound in covers printed with colour match values in steps of 0.5 pH (0.3 pH for most Comparator papers).

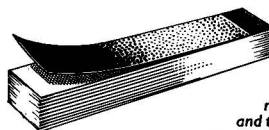

The cut papers measure $2\frac{1}{2} \times \frac{3}{4}$ " and the books are packed in cartons of six. Large sheets are available if required.

Johnson's also supply Litmus Paper, plus a range of nearly forty other Test Papers for more specific uses.

Write for leaflet and prices.

335, Hendon Way,
N.W.4.

JOHNSONS
OF HENDON LTD

Fluorescent Indicators

Eastman lists fifty-seven colour-changing pH indicators which are of use when they give a colour visible in the material titrated. Alternatively there are available twenty-three Eastman Fluorescent Indicators. Our newest compound with this property is :

Eastman 7398

trans-o-Hydroxycinnamic acid

for titrating weak acid against strong base. It is said to assume a green fluorescence in passing from pH 7.2 to 9.0.

It is also reported to detect mercurous ions among mercuric ions and to inhibit zygote germination in the green alga, *Chlamydomonas eugametus*.

Eastman Organic Chemicals now comprise over 3,600 interesting items.

Kodak LIMITED

KIRKBY INDUSTRIAL ESTATE
KIRKBY, LIVERPOOL

Telephone: Simonswood 2977/8

BINDING

Have your back numbers
of The Analyst bound in
the standard binding case

Send the parts together
with a remittance for 12/6

to:

W. Heffer & Sons Ltd
Hills Road Cambridge

peak performance in polarography

—determines
0.001 p.p.m.

The new MERVYN-HARWELL SQUARE WAVE POLAROGRAPH MARK III combines in one Instrument, all the special needs of the Polarographer who wishes to exploit fully the exceptional merits of this outstanding Analytical Technique.

- Extreme Sensitivity
- Exceptional Selectivity
- Completely self-contained
- Great Versatility
- Ultimate in convenience
- Resolves 20 m.v.
- Built-in cell, thermostat Nitrogen supply and recorder
- Reversible and Irreversible reactions
- All controls located and ganged for rapid and accurate operation

MERVYN INSTRUMENTS
ST. JOHN'S • WOKING • SURREY
Telephone: WOKING 5200

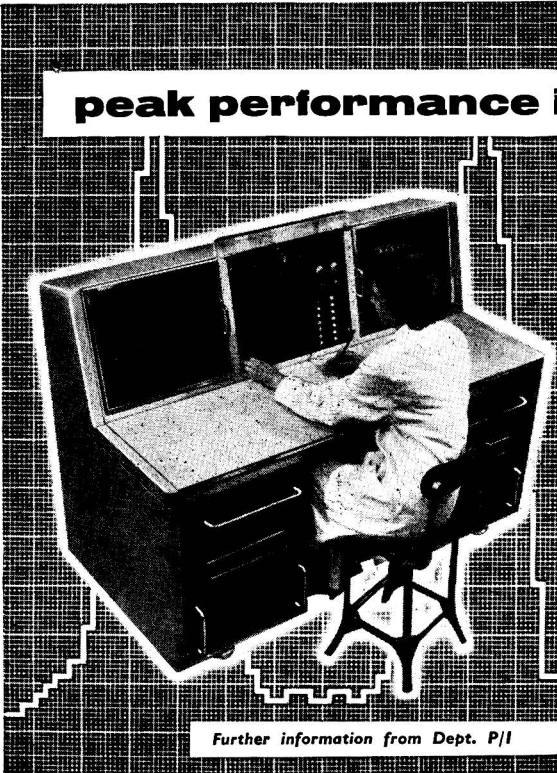

Further information from Dept. P/1

PB12a

. . . . the unerring laws

"Chemical science during the last quarter of a century has made such extended progress that our arts and manufactures assume altogether a different aspect. Those chemical arts which formerly were rudely conducted by the system termed the 'rule of thumb' are now methodically organised and arranged in accordance with the unerring laws of chemistry . . . Hence, not only are more accurate and uniform results obtained, but success and economy take the place of failure and waste." (Chemical News, 1859, 1, 1).

Here, in the first number of 'Chemical News' published nearly a hundred years ago, the eventual development of scientific control of the methods and means of production is welcomed perhaps a little prematurely; but in thousands of industrial laboratories to-day 'the unerring laws of chemistry,' and B.D.H. reagents, enable the conduct of the chemical arts to be successful and economical . . . and as civil as you please.

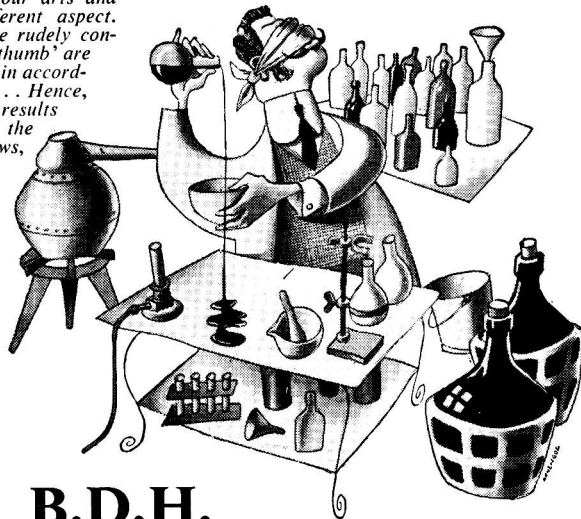

B.D.H. LABORATORY CHEMICALS

THE BRITISH DRUG HOUSES LTD. B.D.H. LABORATORY CHEMICALS GROUP POOLE DORSET
LC/P/9dt

THE ANALYST

THE JOURNAL OF THE SOCIETY FOR ANALYTICAL CHEMISTRY

PUBLICATION COMMITTEE

Chairman: J. R. Nicholls, C.B.E. *Members:* N. L. Allport, A. L. Bacharach, R. C. Chirnside, L. Eynon, D. C. Garratt, J. Haslam, H. M. N. H. Irving, W. C. Johnson, M.B.E., R. F. Milton, F. L. Okell, A. A. Smales, George Taylor, O.B.E., L. S. Theobald, C. Whalley, K. A. Williams, E. C. Wood, and the President and Honorary Officers.

President of the Society: J. H. Hamence

Hon. Secretary of the Society:
R. E. Stuckey

Hon. Assistant Secretary of the Society:
S. A. Price

Hon. Treasurer of the Society:
A. J. Amos

Advisory Editor:
F. L. Okell, F.R.I.C.

Editor:
J. B. Attrill, M.A., F.R.I.C.

Assistant Editor:
P. W. Shallis

CONTENTS

	<i>Page</i>
Proceedings of the Society for Analytical Chemistry	
New Members	1
Deaths	1
North of England Section	1
Scottish Section	1
Western Section	1
Midlands Section	2
Physical Methods Group	2
Original Papers	
Recent Advances in the Preparation and Uses of Ion-exchange Resins—D. K. Hale ..	3
The Determination of Uranium by Solvent Extraction	
Part I. The Separation of Uranium-233 from Irradiated Thorium as the Diethyldithiocarbamate Complex—W. H. Hardwick and M. Moreton-Smith	9
Part II. The Separation of Uranium-233 from Irradiated Thorium as the Oxine Complex in the Presence of Ethylenediaminetetra-acetic Acid—R. F. Clayton, W. H. Hardwick, M. Moreton-Smith and R. Todd	13
The Molybdate Method for the Determination of Phosphorus, Particularly in Basic Slag and in Steel—D. Stockdale	24
Determination of the Major Constituents of Small Amounts of Tissue—John Paul ..	37
Simultaneous Determination of Water and Carbon Dioxide in Rocks and Minerals—J. P. Riley	42
Recommended Methods for the Analysis of Trade Effluents—Methods for the Determination of Phosphorus and Acid-soluble Sulphate	50
Notes	
The Determination of Manganese in Titanium—J. A. Corbett	53
The Application of the Polarised Platinum Electrode to the Determination of Ascorbic Acid in Fruit Products—R. C. Curtis	54
A Note on Silver Nitrate Titrations—W. F. N. Leitch and F. A. Lewis	55
Apparatus	
A Compact Unit for Potentiometric and "Dead-stop End-point" Titrimetry—John T. Stock ..	56
A Suction-operated Differential Electrode System for Potentiometric Titration—John T. Stock	57
British Standards Institution	59
Book Reviews	
Micro-Analysis in Medical Biochemistry. By E. J. King and I. D. P. Wootton	59
The Chemistry of the Coordination Compounds. Edited by John C. Bailar, jun	60
Amino Acid Handbook: Methods and Results of Protein Analysis. By Richard J. Block and Kathryn W. Weiss, and others	61
Human Protein Requirements and their Fulfilment in Practice. Edited by J. C. Waterlow and Joan M. L. Stephen	61
A Guide to Qualitative Organic Chemical Analysis. By R. P. Linstead and B. C. L. Weedon ..	62
Supplement to Mellor's Comprehensive Treatise on Inorganic and Theoretical Chemistry Supplement II. Editorial Board: H. V. A. Briscoe, A. A. Eldridge and G. M. Dyson ..	63
Vitamin A. By Thomas Moore	63
Organic Analysis. Volume III. Edited by J. Mitchell, jun., I. M. Kolthoff, E. S. Proskauer and A. Weissberger	64
Publications Received	64

Printed and Published for the Society for Analytical Chemistry by W. Heffer & Sons Ltd., Cambridge, England. Communications to be addressed to the Editor, J. B. Attrill, 14 Belgrave Square, London, S.W.1. Enquiries about advertisements should be addressed to Walter Judd Ltd., 47 Gresham Street, London, E.C.2.

Entered as Second Class at New York, U.S.A., Post Office