

Environmental PROTECTION

Management and Problem-Solving for Environmental Professionals

JANUARY 1996

1996
Buyer's Guide

**What will the
new year bring?
Executives forecast
the future**

**EPA Works Bugs
Out of Water Systems**

**Future Hazy for Air Pollution
Control Equipment Market**

**Get The Scoop on
Buyers' Intentions**



กองสนทนาวิจัยและพัฒนาเทคโนโลยี



- ☑ Special Edition for Purchasing Agents
- ☑ Over 3,100 Full-Color Pages
- ☑ Expanded Comprehensive Subject and Part Number Indexes
- ☑ Thousands of New Exciting Products
- ☑ Complete Ordering Information and Prices Included

PURCHASING AGENTS!
REQUEST YOUR FREE
2-VOL. SET OF
OMEGA'S PURCHASING AGENT
EDITION TODAY!

Circle No. 1 for Handbook request form or request Document #9993 from the OMEGAfax™ Service

OMEGA Proudly Announces the Arrival of our Newest Editions!

More Than 40,000 Items Offered for Process Measurement and Control with Prices and Ordering Information

OMEGAfax SM

OMEGA's 24-Hour-a-Day, On-Demand Publishing Service
Dial 1-800-848-4271

from any Touch-Tone phone, and just enter document # 9993. A Handbook request form will be sent to you automatically. Don't forget to have your fax number handy!

For Sales and Service Call:

1-800-82-66342 SM
1-800-TC-OMEGA

OMEGA Engineering, Inc.

One Omega Drive, P.O. Box 4047
 Stamford, CT 06907-0047
 Tel: (203) 359-1660 Fax: (203) 359-7700

© COPYRIGHT 1996 OMEGA ENGINEERING, INC. ALL RIGHTS RESERVED



NEW!
 See OMEGA on
 The WORLD WIDE WEB!

OMEGAnet SM
 ON-LINE
 SERVICE

<http://www.omega.com>



Ω OMEGA®

Environmental PROTECTION

January 1996
Card Expires March 1996
Reader Service Card
035709601060

FREE INFORMATION

For FREE information on products advertised in this issue, circle their Reader Service Number on the card below. Please type or print clearly and answer all the questions on the card.

PLEASE SEND ME FREE INFORMATION ON THE FOLLOWING ITEMS:

1	2	3	4	5	6	7	8	9	10	11	12	13	14	15	16	17	18	19	20
21	22	23	24	25	26	27	28	29	30	31	32	33	34	35	36	37	38	39	40
41	42	43	44	45	46	47	48	49	50	51	52	53	54	55	56	57	58	59	60
61	62	63	64	65	66	67	68	69	70	71	72	73	74	75	76	77	78	79	80
81	82	83	84	85	86	87	88	89	90	91	92	93	94	95	96	97	98	99	100
101	102	103	104	105	106	107	108	109	110	111	112	113	114	115	116	117	118	119	120
121	122	123	124	125	126	127	128	129	130	131	132	133	134	135	136	137	138	139	140
141	142	143	144	145	146	147	148	149	150	151	152	153	154	155	156	157	158	159	160
161	162	163	164	165	166	167	168	169	170	171	172	173	174	175	176	177	178	179	180
181	182	183	184	185	186	187	188	189	190	191	192	193	194	195	196	197	198	199	200

Please peel address label from cover and affix below. For faster service photocopy this side only and send to our FAX # (817) 662-7075.

NAME _____

TITLE _____

COMPANY _____

ADDRESS _____ Home Bus.

CITY _____ STATE _____ ZIP _____

- YES, I would like to receive/continue to receive *Environmental Protection*.
- NO, I'm not interested at this time.

Signature _____ Date _____

Title _____

Signature Required For FREE Subscription

Business Phone (____) _____ FAX No. (____) _____

Home Phone (____) _____

* Function which best describes your activity in Pollution Control (check only one):

- A Corporate responsibility for Pollution Control
- B Manage all Pollution Control Operations at this location
- C Supervise sub-group in Pollution Control Operations
- D Provide professional consulting service on Pollution Control
- E Provide staff environmental service on Pollution Control
- Z Other (please specify) _____

2. Type of Business (check only one)

A Manufacturing. If manufacturing, please check the appropriate SIC (check only one):

- | | |
|-----------------------|---------------------------------------|
| J (20) Food | J (30) Rubber/Plastic |
| J (21) Tobacco | J (31) Leather |
| J (22) Textile | J (32) Stone/Clay/Glass |
| J (23) Apparel | J (33) Primary Metal |
| J (24) Lumber & Wood | J (34) Fab. Metal |
| J (25) Furniture | J (35) Mach., except Elect. |
| J (26) Paper | J (36) Elect. & Electron. Mach. |
| J (27) Print/Publish | J (37) Trans. Equip. |
| J (28) Chemicals | J (38) Instru/meas/analyz/controlling |
| J (29) Petrol. & Coal | J (39) Miscellaneous Mfg. |

- B Mining
- C Agriculture
- D Engineering & Contracting
- L Consulting
- M Insurance
- E Utilities, public, private & cooperative
- F Govt. including municipal or district sanitary water or wastewater trmnt. sys. or plants

Type of Govt:

- G City H County
- I State J Federal
- K Transportation
- N Labs O Training P Real Estate
- Z Misc. Services _____ (please specify)

3. Approximate number of employees at this address (check only one):

- A 1-19 E 250-499 H 1500-2499
- B 20-49 F 500-999 I 2500 and up
- C 50-99 G 1000-1499 D 100-249

4. In your job function do you recommend, specify or purchase?

(check all that apply):

- A Pollution Control Equipment
- B Instrumentation
- C Chemicals
- D Parts & equipment for maintenance operation and control
- E Services/Consulting
- F None of the above _____ (please specify)

5. What types of Pollution Control are you responsible for? (check all that apply):

- A Air F Toxic & hazardous materials
- B Water G Energy control/energy conservation
- C Noises H None of the above _____ (please specify)
- D Solid waste disposal
- E Industrial hygiene

6. Which of the following publications do you receive personally addressed to you? (check all that apply):

- A Pollution Engineering
- B Environment Today
- C Environmental Solutions
- D Pollution Equipment News
- E The National Environmental Journal
- F Water Environment & Technology
- G None of the above _____ (please specify)



NO POSTAGE
NECESSARY
IF MAILED
IN THE
UNITED STATES

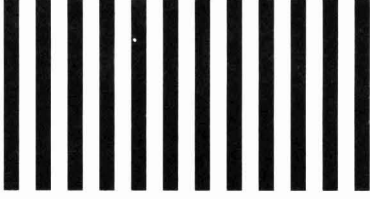

BUSINESS REPLY MAIL
FIRST CLASS PERMIT NO. 1791 WACO, TX

POSTAGE WILL BE PAID BY ADDRESSEE

Stevens Publishing
**Environmental
PROTECTION**
Reader Service
Management Department
P.O. Box 2573
Waco, TX 76702-9910



THE RIGHT PUMP FOR THE JOB.

Selecting the right pump for your particular application can be difficult. Whatever your specifications, we have the right pump for the job.

Complete this form and fax it to us. Our experts will study your pumping requirements and provide an immediate recommendation based on the information you supply.

PLEASE CHECK THE PUMPS THAT YOU ARE INTERESTED IN.



SOLIDS AND CORROSIVE LIQUIDS

T and 10 Series pumps are designed for economical, trouble-free operation in handling solids, corrosive liquids and slurries.

Size: 1½" - 10" Max. Capacity: 3400 GPM
Max. Head: 130 Feet Max. Solids: 3"



HIGH-EFFICIENCY SOLIDS AND CORROSIVE LIQUIDS

U Series pumps are the most efficient self-priming pumps available. Efficiencies up to 75%.

Size: 3", 4", 6" Max. Capacity: 1500 GPM
Max. Head: 207 Feet Max. Solids: 1¼"



LIMITED SOLIDS, CORROSIVE AND CLEAR LIQUIDS

80 and O Series pumps are high-efficiency pumps designed for non-stop workloads. O Series pumps have a straight-in suction design which eliminates entrance restrictions and provides better suction performance when handling solvents and similar liquids.

Size: 1¼", 1½", 2", 3", 4", 6", 8" Max. Capacity: 2100 GPM
Max. Head: 400 Feet Max. Solids: 2½"

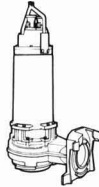

SUBMERSIBLE PUMPS

Stainless steel fitted and all stainless pump models are available for highly corrosive applications.

Size: 1½" to 12" Max. Capacity: 9500 GPM
Max. Head: 600 Feet Max. Solids: 5½"

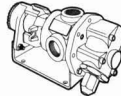

POSITIVE DISPLACEMENT

G Series rotary gear pumps can handle pressures up to 400 PSI.

Size: 1", 1½", 2", 2½", 3", 4" Max. Pressure (PSI): 400
Min. - Max. Capacity: 3 - 310 GPM
Viscosity (SSU): 250,000 Temp.°F: -60° to 675°

ADDITIONAL MODELS:

- Self-Priming Centrifugal Pumps
- Standard Centrifugal Pumps
- Engine-Driven, Self-Priming Centrifugal Pumps
- Diaphragm Pumps

Tell Us About Your Specific Application

Name _____ Title _____

Company Name _____

Address _____

City _____ State _____ Zip _____

Phone Number _____ FAX Number _____

Liquid being pumped _____ Required GPM _____

Suction lift _____ Materials of construction _____

Discharge head _____

Additional Comments _____



The Gorman-Rupp Company
305 Bowman Street
Mansfield, OH 44901-1217

Phone: 419-755-1011 • Fax: 419-755-1251

© Copyright, The Gorman-Rupp Company, 1994

FAX: 419-755-1251

C-301 REV. 4/95

Fax to us for immediate analysis of your pumping application.

<http://www.gormanrupp.com> Circle 2 on card. grsales@gormanrupp.com

HERE'S SOMETHING ELSE YOUR ENVIRONMENTAL ENGINEERING FIRM CAN DEPEND ON

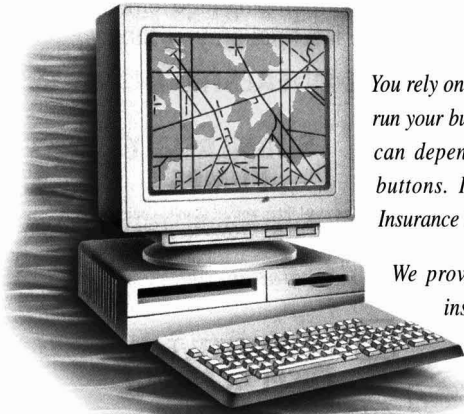

You rely on all sorts of technical equipment to run your business. But there's another tool you can depend on that doesn't have dials or buttons. It's the Environmental Liability Insurance Program from CNA/Schinnerer.

We provide broad professional liability insurance including pollution liability and contractors' pollution liability coverage for environmental engineers and consultants. Of course, that's only natural since we invented professional liability insurance for engineers almost 40 years ago. And now we're breaking new ground with reliable and cost-effective coverage that meets your environmental liability needs.

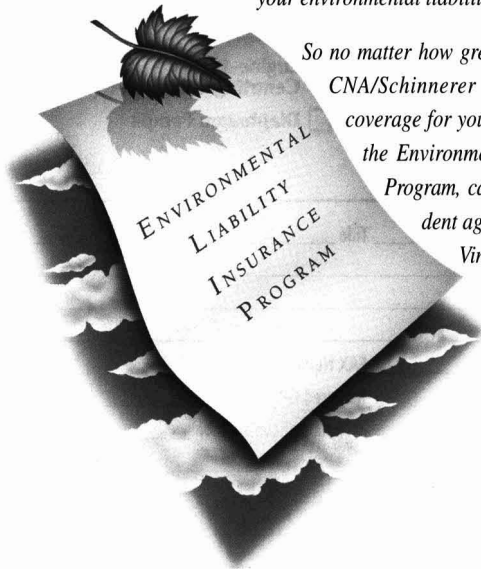
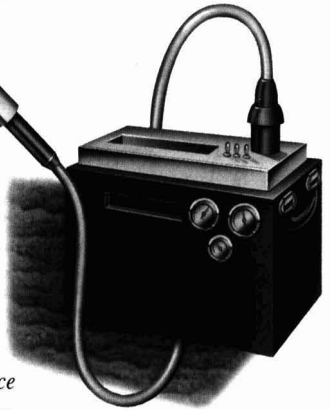

So no matter how great or small your risk, CNA/Schinnerer has the appropriate coverage for you. To learn more about the Environmental Liability Insurance Program, call or have your independent agent or broker contact Cris Vincent at (301) 951-9740.

Victor O.

Schinnerer
& Company, Inc.

CNA

For All the Commitments You Make®

Victor O. Schinnerer & Company, Inc. Two Wisconsin Circle, Chevy Chase, MD 20815-7022. Phone: (301) 961-9800. Fax: (301) 951-5444. Coverage provided by Continental Casualty Company, one of the CNA Insurance Companies/CNA Plaza/Chicago, IL 60685. CNA is a registered service mark of the CNA Financial Corporation. This advertisement is not a contract. Only the policy can provide the actual description of services, terms, conditions and exclusions. Program availability is subject to approval by your state insurance department.

Circle 3 on card.

Cover:

EP asked corporate leaders from different segments of the environmental business community to gaze into their crystal balls and make predictions about significant trends they see occurring in 1996. Turn to page 16 to see our executive soothsayers' forecasts about where the environmental field is headed in the new year.

Photo: Joe Griffin

Environmental PROTECTION

FEATURES

12 Health of APC Equipment Market Rests with EPA

By Melanie Woiwode

16 Looking into the Future

By the *EP* Staff

20 New EPA Program Targets Pathogens in Drinking Water

By Paul S. Berger

26 Buyer Intention Survey

By the *EP* Staff

28 Guarding Against Odors

By Edmund H. Stitt, Keith Kelly,
Anthony R. Elgood and Martin E. Fakley

33 Carbon Injection Proves Effective in Removing Dioxins

By Douglas R. Roeck and Alfred Sigg

36 Using Horizontal Wells as a Remediation Tool

By David L. Russell

44 Integrated In-Situ Remediation

By Vincent Fustos and Paul Lieberman

54 Air Pollution Control in an Age of Prevention

By Jeffrey C. Smith

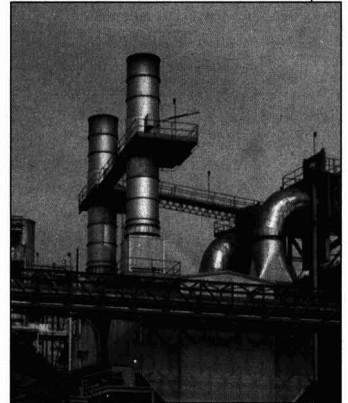

Page 12

DEPARTMENTS

6 From the Editor

8 News Update

11 The Grapevine

50 Training
*Setting Up and Conducting
Training Reinforcement Systems*

By Carol Kefford Eshelman
and Craig A. Woodacre

61 Editorial Index

64 Products and Services

73 Product Literature

76 1996 Buyer's Guide

151 Classified Ads/
Professional Directory

162 Advertiser Index

ขอสงวนลิขสิทธิ์ในบทความและภาพในเล่ม
1 - 9 21 2545

Crystal Ball Fogged For 1996

The cloud of uncertainty currently hanging over several major environmental laws makes it hard to look ahead into 1996. Several pieces of proposed legislation pending before the 104th Congress, if enacted, could have a dramatic impact on the environmental business community.

Significant changes to the Clean Air Act could happen in the coming year. One proposed amendment would limit the Environmental Protection Agency's power to require sources to obtain or modify Title V permits before making operational changes. Another proposed amendment would preclude enhanced monitoring regulations from requiring the installation of additional controls.

The Clean Water Act rewrite proposal pending before Congress deals with several important issues, such as storm water management and wetlands. Some advocates of reforming the wetlands' definition call the current version of Section 404 under the CWA a "bureaucratic swamp" in need of massive revision.

Another area of uncertainty is the final outcome of the Endangered Species Act reauthorization. Controversial issues include the protection of endangered species' habitat on private land and government's obligation to pay landowners if habitat preservation efforts devalue their property.

In addition, the push for reforming the Comprehensive Environmental Response, Compensation and Liability Act would eliminate several types of liability under the current law. The proposed legislation could radically change the effect of the Superfund law on hazardous-waste cleanups. Proponents stress that the bill's main goal is to get small businesses out of the liability loop.

The Republican-dominated Congress recently slashed the EPA's budget as part of its seven-year deficit-reduction plan. A 21-percent cut in enforcement activities will no doubt impact the EPA's ability to enforce existing environmental regulations in 1996.

In light of the many possible changes in the federal environmental laws that could soon go into effect, *Environmental Protection* turned to several environmental business leaders to get their views of what lies ahead in 1996.

Even though it's hard to read a crystal ball under such murky conditions, these corporate managers braved the elements and identified some very clear trends shaping up in 1996. We invite you to take a glimpse into the coming year through the eyes of our environmental executives.



Angela Neville
Editor-in-Chief

Environmental PROTECTION

EDITORIAL

Publisher **Craig S. Stevens**
Associate Publisher **L. Alan Stevens**
Editor **Angela Neville, JD, REM**
Managing Editor **Vicky Boyd**
Assistant Editor **Marion Petty**
Contributing Editors **Paul S. Berger**
Anthony R. Elgood
Carol Kefford Eshelman
Martin E. Fakley
Vincent Fustos
Keith Kelly
Paul Lieberman
Douglas R. Roeck
David L. Russell
Alfred Sigg
Edmund H. Stitt
Jeffrey C. Smith
Melanie Woiwode
Craig A. Woodacre

PRODUCTION/MARKETING

Advertising
Production Manager **Eliska S. Beaty**
Graphic Layout Supervisor **Wes Jordan**
Graphic Production
Sandra Danna
Brenda Dennis
Regina Kubelka
Wynnona Morse
Jim Reeves
Helen Tuohy
Circulation/Marketing
Manager **Mark D. Rathe**

ADVERTISING SALES

National Sales Manager **George Stevens**
(708) 441-2975
District Sales Managers
East Coast **Kurt Kriebel**
(770) 552-4262
Midwest **Paul Burkett**
(817) 662-7054
Southeast/South Central **Devin Drelling**
(214) 687-6700
West Coast **Patty Wehr**
(415) 721-0644
Classified Sales Manager **Mark Rosas**
(817) 662-7101
National List Manager **Ron Hunn**
(817) 662-7088

ADMINISTRATION

President **Craig S. Stevens**
Controller **David Martin**
Vice President, Operations **John Anzelmo**

Environmental Protection welcomes readers' letters; unsolicited manuscripts; suggestions for articles and photo shoots; and releases of news, products, services, literature, non-profit resources, business updates and meetings. Editorial Offices: *Environmental Protection*, 3630 I-35, Waco, Texas 76706; or phone (817) 776-9000.

Stevens Publishing grants authorization to photocopy/reproduce items for personal, internal, client, academic and educational use, provided that a base fee of \$.50/copy plus \$.03/page (fee code 0362-4064/95) is paid directly to Copyright Clearance Center, 222 Rosewood Drive, Danvers, MA 01923; (508) 750-8400.

**Ashland can help you keep
the delicate balance
between chemical
waste management and
efficient operation.**

More than ever, sound and cost-effective management of chemical waste has become a matter for experts. As the leader in distribution of chemicals and chemical products, Ashland offers one of the most comprehensive chemical waste management programs across North America.

We provide access to a complete network of environmental services: collection, treatment, disposal, recycling, recovery or other services, based on expert evaluation of your operation and needs. We also bring the resources and expertise to lead you safely through the maze of regulations, licensing, and other environmental requirements you face—important, since by law you never really relinquish responsibility for your chemical waste.

Every phase of your personalized chemical waste management program is correctly and legally handled...from initial Waste Profile prepared just for your company, through regular scheduled collection, handling and/or disposal, to professional assistance with the complex paperwork involved.

And, because we know the chemical and process industries, we're well suited to help you get the sound waste management you need, keeping your operation efficient and cost effective. Call us your safety net. For information, contact your Ashland Chemical representative, or call our Environmental Services hot line today: 1-800-637-7922. Or write: Ashland Chemical Company, Dept. 466, P.O. Box 2219, Columbus, OH 43216. Fax: 614-790-3426.

HOW DIVERSIFIED ARE WE? ASHLAND CHEMICAL IS CHEMICALS, SPECIALTIES, RESINS AND PLASTICS FOR... ADHESIVES • AUTOMOTIVE & TRANSPORTATION • BOAT BUILDING • CHEMICAL PROCESS INDUSTRIES • CHEMICAL WASTE MANAGEMENT • COMPOSITES • COSMETICS • ELECTRONICS • FOODS • FOUNDRY • HOUSEHOLD & INSTITUTIONAL FORMULATING • MERCHANT MARINE • METAL WORKING • PAINTS & COATINGS • PETROCHEMICAL PRODUCTS • PHARMACEUTICALS • PLASTICS PROCESSING • SEMICONDUCTOR PRODUCTION • WATER TREATMENT **SPECIALIZED SERVICES AND SYSTEMS FOR...** CHEMICAL WASTE MANAGEMENT, RECOVERY & RECYCLING • COOLING, BOILER AND PROCESS WATER TREATMENT • FUEL TREATMENT • SHIPBOARD AND OFFSHORE SERVICES—ASK FOR THE DETAILS.



Circle 4 on card.

Ashland Chemical

Ashland Chemical Company
Division of Ashland Inc.

NEWS UPDATE

Study Predicts Mixed Outlook for Environmental Industry

Though all major sectors of the environmental industry showed revenue growth in excess of inflation for the first half of 1995, the trend may not continue, according to a Washington, D.C., management consulting firm.

Cuts in the Department of Defense remediation budgets may adversely impact the remediation services market in 1996, said Alan Farkas of Farkas Berkowitz & Co.

Citing the firm's recent annual state-of-the-industry report, Dr. Joan B. Berkowitz

said indices of publicly traded firms in all major sectors of the environmental industry showed revenue growth well in excess of the inflation rate in the first half of 1995 compared to the same period in 1994. She attributed the growth largely to acquisitions.

Operating margins, on the other hand, were either unchanged or declined for all sectors except solid waste. Improved cost management led to a decline in the number of firms experiencing operating losses, from 14 in the first half of 1994 to nine in the first half of 1995.

But the picture may not be as bright for

1996, said Farkas. A \$300 million reduction in the Department of Defense's fiscal year 1995 budget reduced remediation spending to below the 1994 level. The reduced spending is already resulting in fewer bidding opportunities and a slowing of task orders under many existing contracts, Farkas said.

He predicted that appropriations for 1996 will likely drop 20 percent from 1995 levels to less than \$1.9 billion. The Environmental Protection Agency also is facing cuts, which could amount to more than 10 percent of the agency's budget.

If that occurs, it could hamper the agency's ability to develop rules in a timely manner, and proposed Republican riders to pending federal legislation, if enacted, could disrupt the agency's enforcement efforts.

On the other hand, he said, the Department of Energy environmental restoration budget will probably increase nearly 20 percent to more than \$1.6 billion.

'Green Revolution' in Boston Helping Mend Polluted Harbor

The 10-year, \$3 billion Boston Harbor Cleanup Project was officially launched in August 1988 after the federal government cited the waterway as one of the most polluted in the country.

More than 90 companies and businesses, such as hospitals, restaurants and institutions, have identified water conservation opportunities that could save up to 1 million gallons per day.

To get the industries on board, the Institutional Water Management Program provided education and free audits where specific water efficiency strategies were recommended. Many of the participants discovered that by conserving water they actually saved on their water bills.

A side benefit of the cleanup was the emergence of several new technologies. The project called for the second largest wastewater treatment plant in the nation and a 9.5-mile effluent outfall tunnel into Massachusetts Bay. The tunnel used a set of 55 risers that guided the wastewater out into the bay through one of 440 ports.

Despite the project's success at reducing organic pollutants, metals and organic chemical contaminants remain in the sediments, and it will be decades before researchers see significant decreases. How the removal of organic material from the harbor will affect lobster and winter flounder—two important commercial species—is yet unknown.

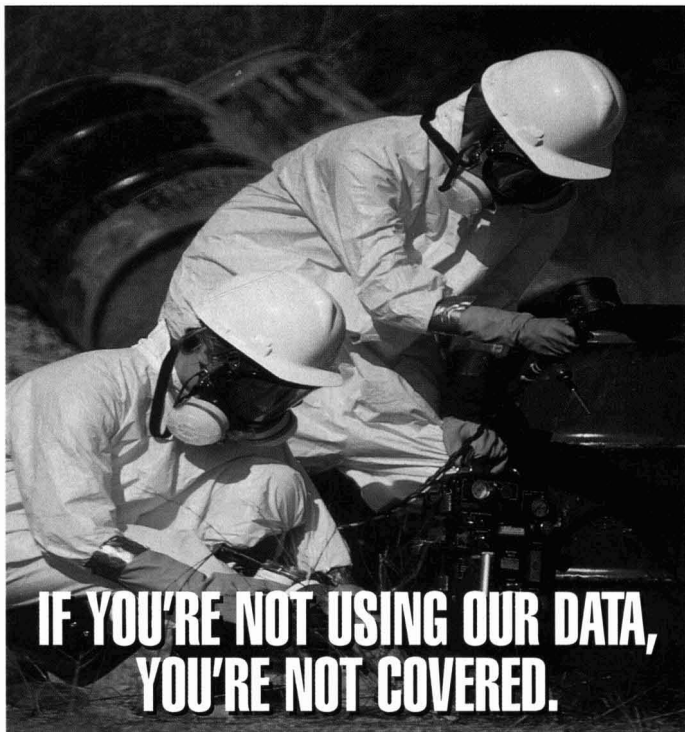

If you're looking for the most current and accurate environmental information available, only VISTA reports give you total assurance and total protection.

VISTA was the first environmental information bureau to offer a choice between hard copy, data files, or the convenience of on-line reports. Nobody delivers more on-line reports than VISTA, and nobody gives you more ways to save time and money. It's no wonder we're the most trusted name in the business.

Call (800) 767-0403 today to take advantage of special price offers and receive a free VISTA Environmental Information Solutions package.

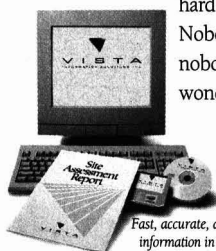

Fast, accurate, and affordable environmental information in the report forms you want: call 1-800-767-0403 today!



VISTA INFORMATION SOLUTIONS INC. ▼ 5060 SHOREHAM PLACE, SAN DIEGO, CA 92122 ▼ (800) 767-0403

'Grunge Busters' May Be Used To Clean Up Puget Sound

Seattle may be home to the "grunge sound" in music and the "grunge look" in attire, but the city's residents draw the line at "grunge water"—polluted waterways that pose a threat to the area's commercial fishing and recreation industries. In tackling the reclamation of one site in Puget Sound, Eagle Harbor, scientists and engineers called on the help of unlikely heroes: naturally occurring microorganisms, such as protozoa and benthic worms.

Sponsored by the University of Washington in Seattle, Wash., and the U.S. Office of Naval Research, the study is designed to provide a better understanding of how waterways can clean themselves through the efforts of tiny marine creatures that break up, change, absorb and remove pollutants. Among the variables being monitored are marine sediment contaminant transport, microbial growth and contaminant biodegradation rates, different microbial species capable of degrading polyaromatic hydrocarbons and the microbial ecology of the site.

With the information, the team will develop chemical reaction engineering models of site restoration, which could, in turn, be used to determine the best strategies for increasing the effectiveness of natural pollution fighters. Much of the study will focus on the effects of "capping" on marine biodegradation.

EPA Helps Rural Town Draft Plan to Protect Private Wells

In an unusual alliance, the Environmental Protection Agency teamed with the 3,000-population town of Tillery, N.C., to address the problem of protecting the community's drinking water wells for the next 15 to 20 years. About 95 percent of the town's residents get their drinking water from 1,700 small-capacity water wells.

Of concern was possible contamination from septic systems, agricultural pesticides and fertilizers, and three new hog operations. Though the EPA does not regulate private water supplies, the agency wanted to look for opportunities to transfer information about protecting public water wells to private water wells.

The community's goal was to create a program to identify and control potential contaminant sources in areas that contribute water to the wells. The EPA provided technical and scientific support in gathering and analyzing data used to determine protection areas. The community retained the respon-

sibility for making the final decisions about which wellhead protection approach to use.

By looking at depth to water, the amount of water pumped and actual yields, the EPA was able to map wellhead protection areas. A WHPA is an area in which potential contaminants and activities that can cause contamination are controlled and managed.

The EPA said that unless an enormous amount of data is available or the time frames for protection are very short, a wellhead protection program faces serious limitations in cases such as Tillery's, where there is a high density of small-capacity

wells. A high degree of protection is desired for each well.

Either the neighbors will have to agree to cooperate to protect the larger resource for all to use or communities will have to protect large areas in order to meet drinking-water protection goals, the EPA said.

Wisconsin, EPA Wage All-Out Campaign Against Mercury

The Environmental Protection Agency is waging a multi-front campaign at virtually eliminating mercury and other chemicals in the Great Lakes Region. Within the

THE BEST IN AIR MONITORING PRODUCTS

Automatic/Isokinetic Stack Sampling System
AUTO 5™

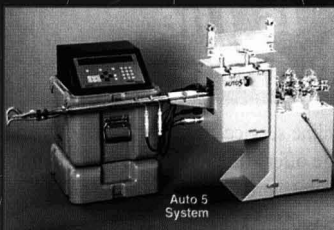

Graseby's AUTO 5™ performs a wide variety of U.S. EPA sampling methods including but not limited to Methods 1-5, 8, 17 and 23.

Measures and records source temperatures, pressures and flow rates automatically

Calculates sampling traverses

Automatically adjusts the Isokinetic sample rate

Easier field data recording and report generation

Floppy disk interface allows pre- and post-test data management

Maintains constant sample flow rate for EPA gas sampling methodology and long-term sampling requirements

WE KNOW AIR!

1-800-241-6898

GRASEBY

500 TECHNOLOGY COURT, SMYRNA, GA 30082
TEL: 770-319-9999 FAX: 770-319-0336

United States, manufacturers use 500 to 600 tons of mercury annually to produce a variety of products, including thermometers, thermostats and fluorescent lights.

Recently, EPA's Great Lakes National Program Office issued a draft option paper calling for the virtual elimination of mercury and other chemicals through a series of actions, including increasing public awareness, encouraging sound mercury management, minimizing mercury usage, and reducing, eliminating and/or decreasing uncontrolled releases. In addition, the plan

calls for managing the disposal of mercury-containing items and mercuric wastes.

A recently released estimate of air emissions of mercury in Wisconsin showed that coal-based power production accounted for more than half of airborne mercury. But it is probably one of the most difficult sectors to target for mercury reduction.

Wisconsin currently has one chlor-alkali plant, which accounts for the next greatest single source of airborne mercury. Municipal and medical waste incinerators account for the next largest sector of mercury.

The Wisconsin Department of Natural Resource's wastewater treatment program will focus on helping publicly owned treatment works identify mercury sources and assist customers in reducing mercury levels.

Ozone Hole Continues to Grow Despite Pact Banning CFCs

As the eighth anniversary of the signing of the Montreal Protocol passed amid little fanfare this fall, the ozone hole over Antarctica continued to grow, according to scientific reports. The growth has continued despite an effort to reduce the amount of chlorine released into the atmosphere.

United Nations ozone expert Rumen Bojkov said that from the end of July through August and early September 1995, ozone levels in the polar region had depleted an average of 1 percent a day—more rapidly than ever before. "Every 1 percent drop in ozone means roughly 1.3 percent to 1.5 percent more ultraviolet radiation" will penetrate the upper atmosphere, Bojkov told the *Washington Post*.

The stratospheric ozone layer, made up of naturally occurring ozone molecules, protects the earth by filtering out harmful ultraviolet radiation produced by the sun.

On Sept. 16, 1987, numerous countries signed the Montreal Protocol, committing to reduce their use of chlorofluorocarbons and other man-made halogenated compounds. A total of 150 have signed the document, which was later amended to ban CFC production after 1995.

If efforts to reduce chlorine releases are successful, the ozone will recover but not before 2050 or 2070, Bojkov said.

Defense Department Wants 'Bang' Taken out of Closed Military Sites

With military base closure in full swing, the U.S. Department of Defense is shifting gears to clean up the closed bases that have unexploded artillery, ammunition, explosive waste and debris. Providing a single-source service, Environmental Science and Engineering Inc. of Peoria, Ill., is investigating and remediating the contaminated sites. The firm is one of the first national consulting and engineering companies to specifically create a separate company dealing with unexploded artillery and explosive waste and debris.

DOD is focusing its attention on cleaning up the sites because the Base Realignment and Closure Act requires former defense sites be cleaned before they are released for civilian development.

continued on page 10

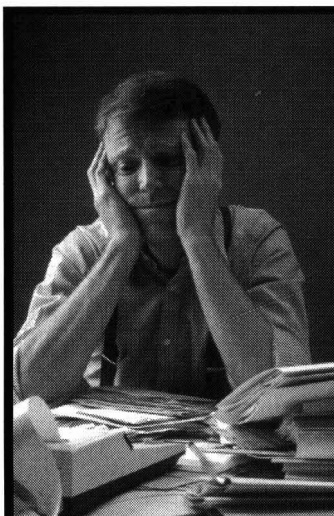

Frustrated Tracking Regulations?

LEGI-SLATE Is The Answer

LEGI-SLATE® is the leading online service covering regulations and Congress. Our exclusive coverage offers timely, reliable and complete, value-added information for regulatory professionals. **LEGI-SLATE is:**

Timely

We provide the full text of today's *Federal Register* (and other documents) today.

Accurate

LEGI-SLATE takes pride in accurate coverage of the latest regulatory and legislative news. Value-added indexing makes it easy to identify information on your issues.

Complete

We offer comprehensive coverage of the *Federal Register*, *CFR*, *U.S. Code*, state regulations, BNA Online®, the U.S. Congress, and more.

Convenient

You don't have to be a computer wizard -- all information in LEGI-SLATE is in a friendly, easy-to-use format.

Save Time. Avoid Aggravation.

Call today to find out how LEGI-SLATE can help you.

(202) 898-2300 (800) 733-1131

(M-F 8:30am-5:00pm EST)

LEGI-SLATE® ▼ 777 North Capitol Street ▼ Washington, D.C. 20002

THE GRAPEVINE



Catharine deLacy

Catharine deLacy was named corporate vice president of health, safety and environmental services for **Allied Signal Inc.**, of Morristown, N.J....**Eder Associates**, a Tampa, Fla., engineering firm, named Paul Bay business development coordinator of its Tampa office....**Midwest Research Institute**, of Kansas City, Mo., was awarded a new five-year, \$12.3 million National Institute of Environmental Health Sciences contract to provide chemical-support services for the environmental toxicology program.

Phoenix Process Equipment Co., of Louisville, Ky., appointed Bob Morfield national sales manager for industrial market sales for the United States and Canada....**Aspects International Limited**, an environmental training and consulting firm based in Cheshire, England, named Dr. Glenn Sunman Asian market development director and Dr. John Betts U.S. market development director.



Richard D. Kuchenrither

Richard D. Kuchenrither, a water quality professional with the Kansas City, Mo.-based Black & Veatch consulting firm, will serve as president of the Water Environment Federation for 1995-96....**TBN Holdings Inc.**, of Cleveland, Ohio, entered into an agreement with Medusa Corp. to serve as manager of the waste-derived fuel facility at Medusa's cement plant in Wampum, Pa....Succeeding Herman Proler as chief executive officer of

Proler International Corp., of Houston, Texas, is the firm's current president and chief operating officer, Steven Gilliland....**United Waste Systems Inc.**, of Greenwich, Conn., announced record earnings for the third quarter and the first nine months ended Sept. 30, 1995.

Wheelabrator Technologies Inc., of Hampton, N.H., announced the formation of a wholly owned subsidiary, Wheelabrator Water Technologies Inc., to provide municipal and industrial water services and technologies....**Fuss & O'Neill Inc.**, a civil and environmental engineering firm with offices in Connecticut, Massachusetts and New York, announced that Thomas G. Hansen, P.E., joined the firm....**Rohm and Haas Co.**, of Philadelphia, Pa., appointed Joan Macey to the newly created position of manager, customer service and communications....**MKS Instruments Inc.**, of Andover, Mass., acquired UTI Instruments Co., of San Jose, Calif., and will operate it as the UTI Division of MKS.

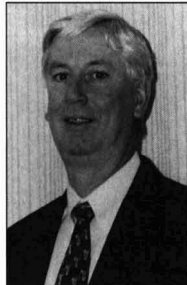

Edward I. Denion

Edward I. Denion was appointed director of business development, corporate staff, at **Semcor Inc.**, of Mount Laurel, N.J....**Ecogen Inc.**, of Langhorne, Pa., agreed to terminate its European research and development agreements with 3A S.r.l., an Italian corporation with which the company had operated a joint-venture company....Bruce N. Diel, Ph.D., joined **Midwest Research Institute**, of Kansas City, Mo., as a principal chemist providing technical support for environmental remediation and technology development....The New Zealand-based Royds Consulting Ltd. merged with **Montgomery Watson Inc.**, of Pasadena, Calif., and will operate as a New Zealand-based subsidiary corporation.

Joining the Sunnyvale, Calif.-based **Trimble** in its surveying and mapping division are George Huber as marketing manager for precise positioning and Dr. Joseph Paiva, senior scientist and technical advisor

for research and development....**Kleinfelder Inc.**, of Sacramento, Calif., named Paul Baginski to lead its San Francisco Bay area environmental program as the regional manager....**Fuel-Tech N.V.** announced that its 50-percent-owned joint venture, **Nalco Fuel Tech**, received two contracts totaling more than \$2.5 million to supply the NOxOUT® process in Germany.

The Wall, N.J.-based firm of **Groundwater & Environmental Services** named Dawn L. Horter as senior hydrogeologist/case manager in its New Jersey office; Wayne Kempksi as senior hydrogeologist in its Melville, N.Y., office; James R. Wagner as senior project manager in its East Providence, R.I., office; and Robert H. Gauppas as project engineer in its Crofton, Md., office.

Dexter & Chaney, the Seattle, Wash., firm that developed FOREFRONT™ accounting and project management software for contractors, named John Ulacia director of operations....The Cape May County Municipal Utilities Authority selected **EMCON** to lay out and design the future cells of the authority's secure sanitary landfill in Cape May County, N.J....**Foamseal Inc.**, one of the country's leading developers and producers of urethane systems, is now part of Illinois Tool Works Inc., of Glenview, Ill.

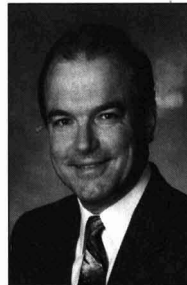

William "Bill" Smith

William "Bill" Smith joined **Scott's Health and Safety Products** group, Monroe, N.C., as marketing manager for industrial distribution....**Layne Geo-Sciences Inc.**, of Mission Woods, Kan., hired David W. Heston as staff civil engineer....**Arcadian Corp.**, of Memphis, Tenn., announced it will pay quarterly cash dividends of about 36.81 cents per share of preferred stock for the third quarter ended Sept. 30, 1995....**Wyle Laboratories Inc.**, of El Segundo, Calif., purchased Siemens Power Corporation's snubber testing and valve engineering services. **EP**

Health of APC Equipment Market Rests with EPA



Most sales increases will probably come from end-users preparing for NO_x control regulations.

As the U.S. market matures, the rest of the world is expected to offer greater export opportunities for air-pollution control companies.

By Melanie Woiwode

THE AIR-POLLUTION CONTROL (APC) market consists of separate but interrelated product segments that differ significantly, both in technologies and opportunities for growth. Revenues for the air-pollution control market are estimated to be \$1.7 billion in 1995, according to Frost & Sullivan. Of all APC equipment, nitrogen-oxide control equipment is the fastest growing segment. Low NO_x burners, selective catalytic reduction (SCR) and selective non-catalytic reduction (NCSR) equipment generated revenue of \$375 million in 1995. Sales of NO_x control equipment are projected to increase to more than \$730 million in 2000, according to Frost & Sullivan research.

The bulk of the increase is expected from

1996 to 1998 as end-users prepare for NO_x control regulations released by the Environmental Protection Agency as part of Title IV of the 1990 Clean Air Act Amendments. A new acid rain rule will cut annual NO_x emissions by 350,000 tons annually beginning in 1996 and by 1.6 million tons annually beginning in 2000. The rule modifies EPA's original NO_x standards issued March 22, 1994. The EPA also extended the NO_x emission compliance date from Jan. 1, 1995, to Jan. 1 of this year. These changes will force end-users to purchase the necessary equipment.

Another incentive that will drive APC purchases is the amount of civil and criminal penalties collected by the EPA in fiscal

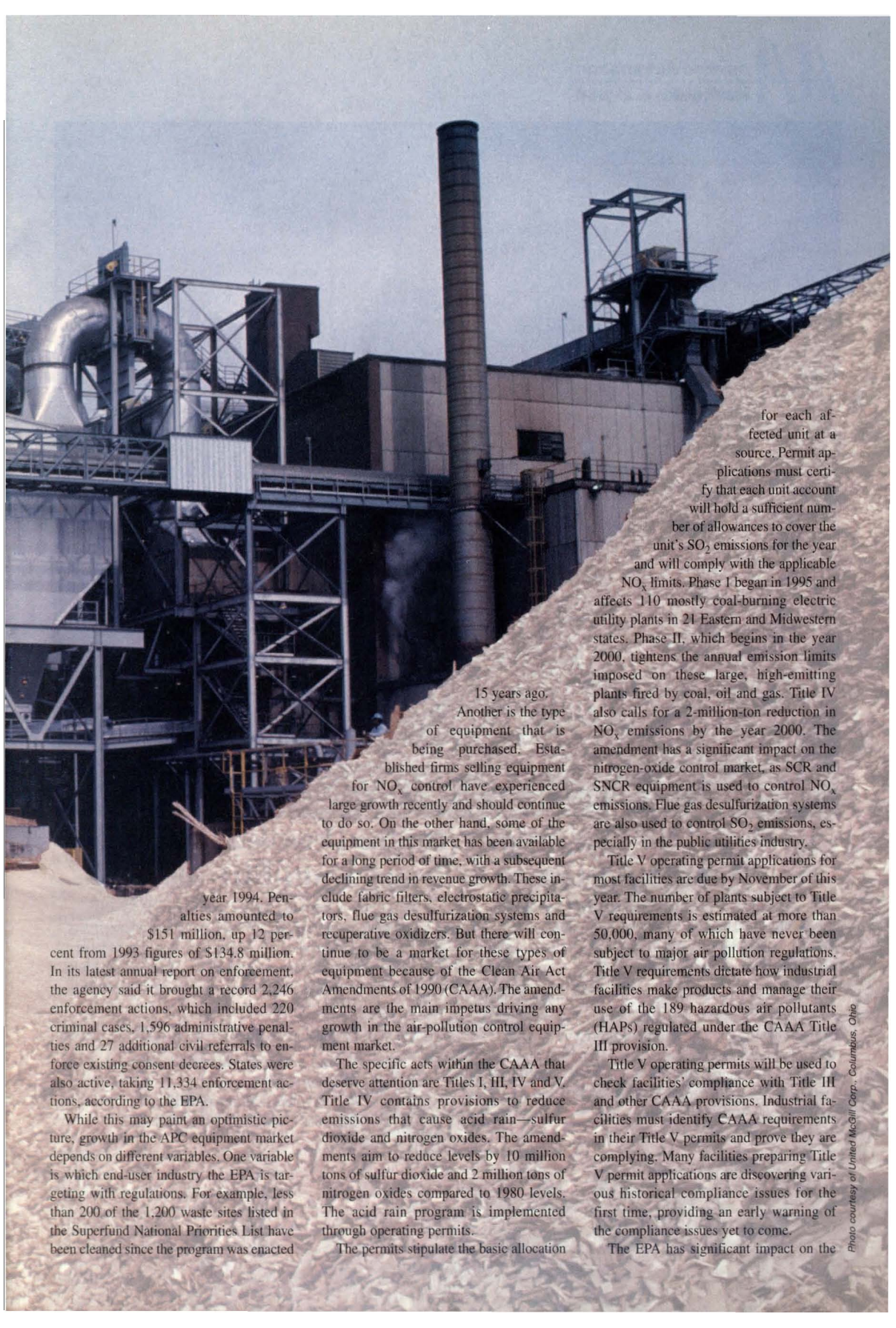

year 1994. Penalties amounted to \$151 million, up 12 percent from 1993 figures of \$134.8 million. In its latest annual report on enforcement, the agency said it brought a record 2,246 enforcement actions, which included 220 criminal cases, 1,596 administrative penalties and 27 additional civil referrals to enforce existing consent decrees. States were also active, taking 11,334 enforcement actions, according to the EPA.

While this may paint an optimistic picture, growth in the APC equipment market depends on different variables. One variable is which end-user industry the EPA is targeting with regulations. For example, less than 200 of the 1,200 waste sites listed in the Superfund National Priorities List have been cleaned since the program was enacted

15 years ago. Another is the type of equipment that is being purchased. Established firms selling equipment for NO_x control have experienced large growth recently and should continue to do so. On the other hand, some of the equipment in this market has been available for a long period of time, with a subsequent declining trend in revenue growth. These include fabric filters, electrostatic precipitators, flue gas desulfurization systems and recuperative oxidizers. But there will continue to be a market for these types of equipment because of the Clean Air Act Amendments of 1990 (CAAA). The amendments are the main impetus driving any growth in the air-pollution control equipment market.

The specific acts within the CAAA that deserve attention are Titles I, III, IV and V. Title IV contains provisions to reduce emissions that cause acid rain—sulfur dioxide and nitrogen oxides. The amendments aim to reduce levels by 10 million tons of sulfur dioxide and 2 million tons of nitrogen oxides compared to 1980 levels. The acid rain program is implemented through operating permits.

The permits stipulate the basic allocation

for each affected unit at a source. Permit applications must certify that each unit account will hold a sufficient number of allowances to cover the unit's SO₂ emissions for the year and will comply with the applicable NO_x limits. Phase I began in 1995 and affects 110 mostly coal-burning electric utility plants in 21 Eastern and Midwestern states. Phase II, which begins in the year 2000, tightens the annual emission limits imposed on these large, high-emitting plants fired by coal, oil and gas. Title IV also calls for a 2-million-ton reduction in NO_x emissions by the year 2000. The amendment has a significant impact on the nitrogen-oxide control market, as SCR and SNCR equipment is used to control NO_x emissions. Flue gas desulfurization systems are also used to control SO₂ emissions, especially in the public utilities industry.

Title V operating permit applications for most facilities are due by November of this year. The number of plants subject to Title V requirements is estimated at more than 50,000, many of which have never been subject to major air pollution regulations. Title V requirements dictate how industrial facilities make products and manage their use of the 189 hazardous air pollutants (HAPs) regulated under the CAAA Title III provision.

Title V operating permits will be used to check facilities' compliance with Title III and other CAAA provisions. Industrial facilities must identify CAAA requirements in their Title V permits and prove they are complying. Many facilities preparing Title V permit applications are discovering various historical compliance issues for the first time, providing an early warning of the compliance issues yet to come.

The EPA has significant impact on the

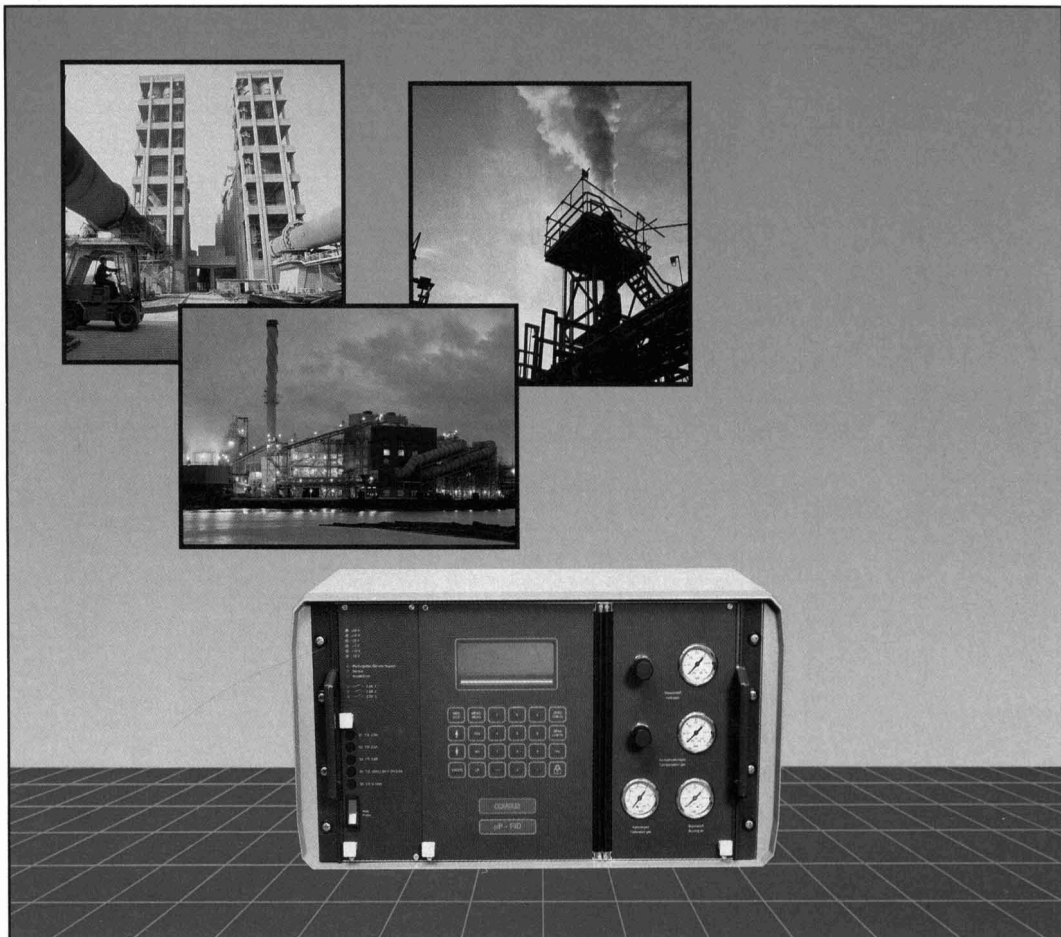

Hydrocarbons Can't Hide From the Detection Capabilities of the Hartmann & Braun Multi-FID 100

Your applications are becoming more and more complex. So reliability and flexibility are logical requirements for any analyzer. **H&B's Multi-FID 100** has the intelligence needed to be reliable and flexible.

The sample is delivered by an air aspirator which delivers a constant sample gas flow to accurately measure trace hydrocarbons, including chlorinated organic compounds with minimal maintenance. It's easy to read LCD-dot matrix display shows all the operational data and status messages in clear text, making the Multi-FID 100 very easy to operate.

Whether you need to monitor hydrocarbons for BIF compliance, control of biofilters and charcoal absorbers and other industrial applications or monitoring volatile hydrocarbons in wastewater with our Stripper, our Multi-FID 100 is your solution for many of your hydrocarbon monitoring problems.

For more information on the **H&B Multi-FID 100**, contact:

Applied Automation\Hartmann & Braun
P.O. Box 9999
Bartlesville, Oklahoma 74005
(918) 662-7000 FAX: (918) 662-7358

a **mannesmann** technology company

APC market. If these regulations are not strictly enforced, however, growth opportunities for air-pollution abatement equipment are reduced. The fact is not a new phenomenon. Industries that have committed to specific HAP-compliance strategies as part of the Title V permit applications without carefully assessing potential Title III requirements may find they face expensive and debilitating permit deficiencies. The CAAA's permit shield provision does not protect permitted facilities from yet-undefined and potentially onerous Title III provisions.

The APC equipment market is diverse, ranging from privately held companies with total annual sales of less than \$10 million to those owned by larger public corporations with annual APC equipment sales of more than \$300 million. Companies in the industry commonly belong to larger public corporations or are divisions or subsidiaries of larger public conglomerates.

While some experts argue that the APC equipment market has experienced little growth and lacks any innovative designs improving the equipment, a few companies deserve attention. One is Monsanto EnviroChem, a manufacturer of mist eliminators and scrubbers that markets the DynaCycle Oxidizer, a regenerative catalytic oxidation (RCO) system for destroying volatile organic compounds in process gas streams. Its catalytic oxidation technology includes regenerative heat recovery technique. Experts believe that Monsanto's RCOs will take away significant market share from regenerative thermal oxidizers.

Another is ARI Technologies, part of Wheelabrator Clean Air Systems, which has developed the PO*WW*ER process that combines evaporative and catalytic oxidation to treat complex wastewaters. The system handles non-volatile and volatile organic compounds, salts and metals.

The process first vaporizes volatile compounds in the evaporator and sends them to the catalytic oxidizer. The oxidizer uses a non-precious metal oxide catalyst to convert organic material to carbon dioxide and water, and inorganic material such as ammonia to nitrogen. It is said to be capable of efficiencies of more than 99.99 percent.

While this is expected to be a decade of minimal growth in the North American APC equipment market, much depends on the EPA's regulatory enforcement. The CAAA have erected the world's most stringent system of monitoring requirements. Canada and Mexico are also becoming more aware of the need to control HAPs.

By many accounts, the North American Free Trade Agreement will have a large impact on environmental concerns in North America. But recent turmoil within the Mexican economy and the Republican-led U.S. Congress may slow needed changes to combat air pollution. This, in turn, could negatively affect the APC market.

Other countries are becoming increasingly aware of the problems that accompany industrial development. Some newly developed countries, such as Taiwan and Singapore, have paid the price of unbridled development.

As the U.S. market matures, the rest of the world is expected to offer greater export opportunities for air pollution control companies.

Public awareness has also increased pressures to control HAPs. Advancements in material science and new production processes have substantially improved the control of pollutants, especially nitrogen oxides and sulfur dioxide. **EP**

Melanie Woiwode is a senior industry analyst with Frost & Sullivan, Mountain View, Calif.

We give you the whole library. Not one volume at a time

You wouldn't buy a book one chapter at a time, so why buy a regulatory compliance database one act, section or manual at a time?

FEDERAL ENVIRONMENTAL & SAFETY AUTHORITY

FESA

Regulatory Compliance CD

ONE PRICE! ONE CD!

Easy to Use:

- **No Reformatting** - FESA seamlessly imports text and tables into any leading wordprocessing software.
- **Concept Trees** - Automatically guide you to the part and section of the regulation you're interested in.
- **Multiple Search Options** - Query by Concept Tree... Menu Assisted Search... Boolean... Command Based... Concept, Range, Phrase and more.
- **Dynamic Hypertext** - you can create your own hypertext links on the fly.
- **Easily Find Any Document** - FESA lets you preview, view, retrieve, edit, fax and print any document using tools you are already familiar with.

Affordable: \$495

Annual Subscription.
30-day money-back guarantee!

Complete:

- **Full-Text Federal Register:** Final Rules, Proposed Rules, Notices, Preambles, Consent Decrees & Notices.
- **Complete CFRs** - Includes Titles 10, 21, 29, 30, 33, 40 & 49 and applicable parts of most other CFRs.
- **Includes STATE Regulations** for most states.
- **Compliance Manuals** - With FESA, you get over 40 manuals for RCRA, OSHA, CERCLA, EPCRA, TSCA and others.
- **Includes SW-846** - Analytical Testing Methods Manual for Solid Waste.

Unique:

The **ONLY** CD that contains all Federal (and most state) environmental regulatory data and more than 40 compliance manuals from governmental agencies all on one CD.

Flexible:

- Annual, Bi-Annual, Quarterly, Bi-Monthly & Monthly Subscription Options.

Up-to-date:

- **Free Bi-weekly Newsletter** with most subscriptions. Reports on daily FR developments, key environmental issues, congressional hearings, *NewsAlerts* from EPA and OSHA, and more.

Use FESA once and you'll know why more people say it delivers today's biggest value in regulatory compliance database technology.

Most complete data base.
Smallest package. Biggest value.



Call today to order,
or for more information.

800-808-3372

WINDOWS - MS DOS - FULL NETWORK



CPI
electronic publishing

CITATION PUBLISHING, INC.
1435 North Hayden Road • Scottsdale, AZ 85257
Tel (602) 994-4560 • Fax (602) 994-4456

© 1995 Citation Publishing, Inc.



Looking into the Future

Executives Forecast Trends for 1996

By the EP Staff

FORECASTING THE FUTURE WOULD be a breeze if we all had crystal balls we could peer into periodically. Even with today's space-age technology, crystal balls only work in movies and novels.

But to get a feel about what environmental businesses can expect in the coming year, we did the next best thing to looking into a crystal ball. *Environmental Protection* asked several leaders of the environmental business community to draw from their extensive backgrounds and expertise to forecast trends they believe might occur.

Based on their backgrounds, the business executives delved into several different subject areas, all of which are major components of the environmental business. And here's what they expect to happen.

*J. Wilson Hershey, Ph.D.,
President,
Lancaster Laboratories*



What can we expect in the environmental lab business in 1996? In a word, uncertainty. Budget cuts for federal agencies will mean less enforcement and fewer samples sent to laboratories. With the federal cutbacks, it is likely many states will pick up some of the slack. Questions remain regarding both the volume and required quality for the state work, since roughly half the states have no lab certification programs for anything other than drinking water.

Judging from the last six months of 1995, which normally are the best six months of the year for environmental labs, closures and consolidations will continue at record-setting levels. It's estimated that 50 to 100 laboratories are currently for sale with few buyers.

Nevertheless, some labs will not only survive but thrive in this

environment. How? By providing clients with exactly what they've always wanted—quality, service and value. The one new requirement is stability. Major industrial firms want a lab that has the necessary experience for their projects and will be there for the long term.



Thomas J. Bloomer,
Director of Marketing,
The Foxboro Company

Manufacturers of pollution-control equipment are beginning to long for the previous decade which thrived on a golden period of strict regulatory enforcement. Those of us who are still fortunate enough to attend trade shows will see row after row of companies with similar products performing the same task, and most of these companies originated and prospered within the past 15 years solely on the basis of regulatory drivers. The good days have passed and the '90s have not been kind to companies competing in the environmental monitoring arena.

Recent government cutbacks have caused the Environmental Protection Agency to reduce, postpone, and in some cases, eliminate the regulatory drivers many equipment manufacturers rely on to stay in business. The longevity of those who survive the current unstable environmental market depends on their ability to execute the following traits: diversification, flexibility and creativity.

It is almost impossible for a month to go by without reading about major acquisitions and mergers. The quickest way for a company to diversify is to acquire companies with new or different technologies that will launch them into new markets.

The new markets should be ones driven by cost payback and productivity vs. the unreliable area of regulatory compliance. Ideally, a new acquisition will also aid in the opening of doors for existing products into these previously undiscovered markets.

Manufacturers who cannot afford to acquire other technologies will have to be extremely flexible and creative. Companies in this situation will be forced to downsize their work force. Employees will

be asked to perform multiple roles and put in longer hours. Normally, an emphasis will be on improving the quality of products, since there will be fewer people available for support.

The customer invariably benefits from either scenario. Instrument manufacturers that acquire other technologies will be able to offer customers solutions to multiple problems from one source. In the other scenario, the company that is forced to improve on quality because of a reduction in support staff now offers a more reliable product to its customers.

In any event, I see an industry that has realized that in order to survive, it must be able to provide solutions for more than one problem and to multiple markets. In addition, no matter what size an organization may be, it must remember that the customer's needs are of the utmost priority, and that its most precious resource will be its employees.



David R. Gaboury,
President,
Woodward-Clyde Consultants Inc.



Charles H. Wahtola,
Executive Vice President,
Woodward-Clyde Group Inc.

The drivers of the environmental engineering industry are undergoing a transformation. Increasingly, our role is evolving from an independent consultant to the client's business partner. That change demands we shift from being a provider of "brains by the hour" to a financial partner concerned about the client's bottom line. We still retain the consultant's scientific objectivity, but our clients also expect advocacy on their behalf.

The new mindset manifests itself in other ways as well. While the consulting mentality focuses on the scope of work, the client-centered mentality focuses on the value of services. The old model features time and

"What can we expect in the environmental lab business in 1996? In a word, uncertainty."

J. Wilson Hershey,
Lancaster Laboratories

"Manufacturers who cannot afford to acquire other technologies will have to be extremely flexible and creative."

Thomas J. Bloomer,
The Foxboro Company

"As outsourcing becomes the wave of the future for industrial water treatment, many more strategic alliances, joint ventures and acquisitions will occur."

John J. Goody,
Wheelabrator Technologies Inc.

"While the consulting mentality focuses on the scope of the work, the client-centered mentality focuses on the value of services."

David R. Gaboury,
Woodward-Clyde Consultants Inc.
and **Charles H. Wahtola,**
Woodward-Clyde Group Inc.

"Along the way, consultants and clients will likely move from a risk-based cleanup approach to use of site-specific criteria..."

Kathleen O. Gill,
Camp Dresser & McKee Inc.

"The information accessibility era will also bring with it answers to questions you may have not yet asked, because you are not aware what is possible."

Thomas R. Gay,
Vista Information Solutions Inc.

Executive Forecast

materials pricing, while the new model features lump-sum pricing with incentives. The consultant solves specific problems, but the partner takes a holistic approach, emphasizing strategic environmental management of all the client's activities.

These changes are driven by global competition and other factors affecting both our private and public-sector clients. In the private sector, corporate environmental departments are being scaled back or outsourced entirely. That's an opportunity as well as a threat, because clients are limiting the number of vendors to a select few who truly understand their needs.

In the public sector, federal budgets are being slashed, while "one size fits all" regulatory standards are giving way to risk-based decisions. The goal remains protecting human health and the environment, but realistic risks, costs and benefits are being factored into regulatory decisions.

Environmental firms are scrambling to adjust to these new conditions. Mergers and acquisitions continue at a frenetic pace, cost reduction reigns and competition for market share is ferocious. The successful firms will have efficient operations, a strong client base and the will to adapt to rapid change in the global marketplace.

Glenn Batchelder,
Vice President of Sales & Marketing, Groundwater Technology

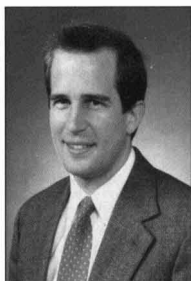

Recently, several remediation projects, or clearly delineated portions of them, have been performed for a fixed fee. Known as lump-sum remediation contracts, they've become increasingly popular because of the many technology improvements in the soil and groundwater remediation field.

Within the past 10 years, considerable strides have been made in site characterization, fate and transport modeling, and remediation technologies. These advancements include powerful computer models which make it possible to evaluate data, as opposed to waiting weeks or months for compilation and analysis. Now, it is possible to predict the performance of remediation technologies and accurately determine the length of treatment time.

Currently, sites most often chosen for lump-sum pricing have relatively homogeneous geology and high hydraulic conductivity and are impacted by relatively easy-to-treat organic chemicals, such as solvents and petroleum hydrocarbons.

Remediation of sites with these characteristics has been well documented over the past 10 years. Although not a panacea, lump-sum procurement has some interesting implications:

- Project costs can be more accurately projected.
- It may be possible to obtain commercial insurance that covers the completion of the remediation project as contracted.
- Banks may be more willing to accept moderately impacted property to secure financing if a lump-sum contract and/or remediation insurance is in place.
- Lump-sum financing shifts the burden of specifying the most appropriate treatment technology to the consultant, who will not hesitate to invest heavily in capital equipment at the outset to reduce total project life cycle time and costs.

Users of soil and groundwater remediation services should know that developments not available three years ago are being applied today. The best solution for mitigating risks and controlling costs takes into account these developments.

Thomas R. Gay,
President & Chief Executive Officer, VISTA Information Solutions Inc.



Imagine, if you can, what your business day would be like without your desktop computer: correspondence without word processing, budgets without spreadsheets and customer files without databases. Not a pretty picture, is it?

Now fast forward your calendar a few years. It's the year 2000. You'll look back and wonder how you ever managed your business without ready access to the information solutions that are now on their way to your desktop. Information availability will change the way you view your clients—and, just as importantly—it will change the way your clients look at you.

In the era of information accessibility,

your response time to client requests will be drastically reduced. *You need it when? No problem!* The information you need will be just seconds or minutes away from presentation in report format. Round-the-clock, seven-day-a-week information availability means you will control your job schedules more completely and improve employee efficiency in the process. More informed and profitable cost estimating will result from access to important data before you begin the project.

The information accessibility era will also bring with it answers to questions you may have not yet asked, because you are not aware what is possible. Would you like to expand your market presence? The environmental-information industry provides detailed profiles on virtually all businesses involved in generating, treating, storing or disposing hazardous wastes. Want to know how the effectiveness of your capital expenditures intends to reduce hazardous waste generation? Compare your performance with that of your competitors. The list of marketing opportunities is virtually endless.

The experts say the information supply available to us doubles every five years, and the pace is accelerating. Increased specialization and market positioning will demand it. The outside information resources, in turn, are becoming more responsive and specialized in their own right. The investment made by these outside resources in data gathering, processing, verification and production yields the most current, cost-effective and highest quality information available.

This data "processing" component produces valuable information for environmental clients. The new year will see increased reliance on information providers. Environmental professionals who take maximum advantage of the new information accessibility era will possess significant leverage over their competitors.



Kathleen O. Gill,
P.E., DEE, Senior Vice President, Camp Dresser & McKee Inc.

Nationwide, urban areas are plagued by abandoned or

under-used industrial and commercial sites where growth and redevelopment are hindered due to real or perceived contamination. Many of these sites are located in prime downtown areas that could provide significant municipal revenues if restored environmentally and revitalized economically.

Over the past decade, affected cities and counties have begun cleaning up and redeveloping these sites themselves, usually under the watchful eye of the EPA or a state agency and often adhering to the cumbersome guidelines of the federal Superfund program. For municipalities with the resources and stamina to implement their own Superfund-type cleanups, the rewards are great; unfortunately, the costs and technical challenges have been largely prohibitive.

Now, the EPA's Brownfields Economic Redevelopment Initiative promises to aid cleanup and redevelopment by providing pilot demonstration grants and relaxing some of the regulatory and liability barriers. The EPA has already funded about 20 projects and plans to support another 30 brownfields pilots in 1996.

The pilots are intended for study and assessment work only, and the EPA encourages participants to seek creative approaches to resolving contamination problems and financing redevelopment. Actual cleanup costs would then be borne by voluntary state programs, tax incentive programs, responsible parties, or funded through other avenues.

The initiative creates opportunities for environmental consulting firms to assist municipalities in proactive and community-minded development projects that have significant environmental components. Full-service consultants—in particular those providing the usual environmental study and cleanup services as well as financial management, public information, administrative and legal assistance—are well positioned to help municipalities make the most of the brownfields grants and achieve long-term redevelopment goals.

For example, one of the earliest brownfields projects is underway in Wichita, Kan., where city officials went to unusual lengths to keep the site off the National Priorities List and joined forces with an environmental consulting firm to undertake a downtown cleanup without federal investigation. Creation of a tax-increment financing project served as a prototype for similar efforts across the country.

The brownfields program represents yet another hesitant step in the EPA's depart-

ture from the unwieldy requirements of Superfund. Consulting firms that "grew up" under Comprehensive Environmental Response, Compensation and Liability Act process must begin realigning their approach to adapt to this more streamlined way of returning sites to productive use.

Along the way, consultants and clients will likely move from a risk-based cleanup approach to use of site-specific criteria, from lengthy feasibility studies to more focused technology selection and application, and from a regimented remediation process to one that values engineering and management creativity in problem-solving.

**John J. Goody, Chief Executive Officer
Wheelabrator Technologies Inc.**



Paine Webber estimates that in 1995 alone, American companies will spend \$1 billion outsourcing water services and, within a decade, this demand will have created a \$15 billion marketplace. While regulatory trends and new technology will help shape this explosive market, the end-user will have the greatest impact on its ultimate configuration.

Water management providers will be the most affected as the market develops. As industrial customers intensify their focus on core competency, water/wastewater treatment suppliers will need to expand their capabilities to provide complete water treatment solutions.

To do so, water treatment companies will broaden their chemical equipment, engineering, process technology and design-build-own-operate capabilities. They will also pursue acquisitions, joint ventures and strategic alliances to meet the growing demands of the industry.

As outsourcing becomes the wave of the future for industrial water treatment, many more strategic alliances, joint ventures and acquisitions will be formed. As this happens, the expertise and synergies of leading water management companies will come together, opening the gates of worldwide industries to reduced water costs, better quality, improved compliance and optimized process efficiencies. **EP**

■ **Reduce pressure drop**

■ **Improve stripping efficiency**

Get the most effective column packing and internals for air stripping and scrubbing.

Jaeger has supplied hundreds of air stripping and scrubbing towers with packing and internals from Maine to Hawaii.

Put our years of experience and our computerized applications technology to work for you.



Jaeger Trough Distributors



Jaeger Tri-Packs[®]

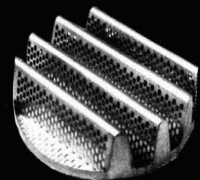

Jaeger Multi-Beam Support

Contact: Jaeger Products, Inc.
1611 Peachleaf • Houston, TX 77039
(713) 449-9500 • Fax (713) 449-9400
800-678-0345

Superior performance by design

JAEGER PRODUCTS, INC.

SEND FOR A FREE BROCHURE

New EPA Program Targets Pathogens in Drinking Water

Recent disease outbreaks have caused water providers to take a hard look at their delivery systems.

By Paul S. Berger

Waterborne disease is a particular concern for the Environmental Protection Agency because it still occurs at unacceptable levels. Between 1986 and 1992, 110 waterborne-disease outbreaks affecting 47,000 people were reported, and the EPA believes that the values are dwarfed by the unreported outbreaks and cases. Currently, the EPA has regulations for 80 chemicals and microbial contaminants.

Yet a number of disease-causing microorganisms and hazardous chemicals still may threaten many source waters and drinking waters. In a number of outbreaks, the contaminants remain undetected, either due to inadequate analytical methods or lack of recognition that they are dangerous and therefore should be monitored and/or controlled.

In many communities, the vast network of pipes distributing water is deteriorating, making systems more vulnerable to fecal contamination and hazardous chemicals. In addition, our growing population burdens the systems.

As a consequence, EPA's Office of Ground Water and Drinking Water (OGWDW) has considered how best to respond to the

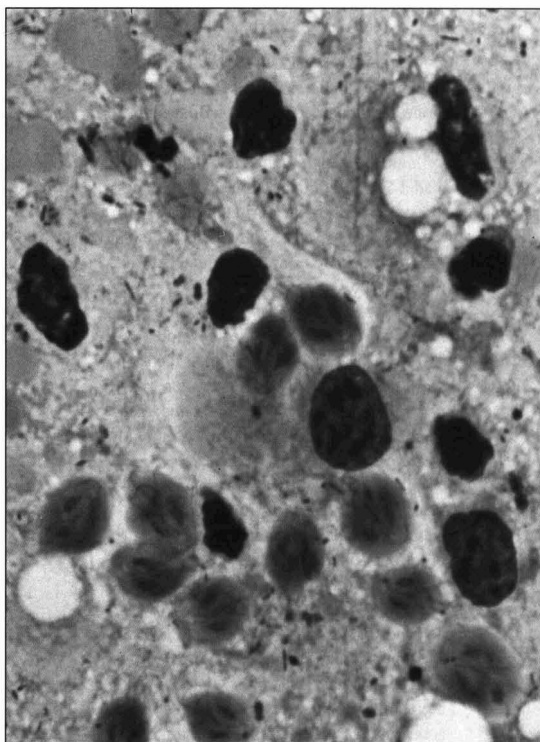

Giardia, shown here magnified 1,250 times, is one of the organisms of concern to drinking water suppliers

increasing problem. Several major developments and trends in drinking water have occurred during the past year, primarily as a result of OGWDW's response. Most of them concern drinking-water microbiology.

Yet important work continues on chemical drinking water contaminants, especially developing a regulation to control hazardous disinfection byproducts resulting from reactions between natural organic matter in the water and disinfectants, such as chlorine used to kill pathogens.

The EPA regulates most known pathogens in drinking water with the Total Coliform Rule (TCR) and the Surface Water Treatment Rule (SWTR). The TCR sets monitoring requirements and a maximum contaminant level for the coliform bacteria group for 200,000 U.S. public water systems. Total coliforms are an indicator of possible pathogen presence.

The SWTR requires a specified level of water treatment for the 10,000 to 15,000 systems using either surface water or groundwater under the direct influence of surface water. Included in the latter category are groundwaters in many limestone areas, which may have numerous sink-

Tom Craig, Texas A&M University College of Veterinary Medicine

How often do you check your oil in water?



How about 24 hours a day, 365 days a year.

Recognized worldwide for its non-fouling, low maintenance operation, the TD-4100 continuously monitors BTEX, gasoline, diesel, jet fuel, crude and refined oils in water. The TD-4100 is accurate and sensitive. The detection limit for gasoline is 5 ppb in clean water. Uninterrupted remote monitoring for continuous discharge, treatment verification, process control, pollution

prevention, or leak detection saves time, money, and sampling hassles. The TD-4100 supports regulated discharge permits for wastewater. The performance of each monitor is guaranteed to meet your needs. Nearly 25 years of experience is built into every TD-4100. Call 408/749-0994 or telefax 408/749-0998 for more information.



TURNER DESIGNS
845 W. Maude Avenue • Sunnyvale, CA 94086
(408) 749-0994 • FAX (408) 749-0998

Circle 11 on card.

Water Quality

holes and other features that allow surface waters to penetrate quickly. OGWDW is currently refining the SWTR (the Enhanced SWTR). It is also developing a third pillar of pathogen control, the Groundwater Disinfection Rule.

Direction Change

In 1995, OGWDW began an extensive reassessment to address a variety of problems with the program, state implementation and needs. The reassessment is being conducted because of concerns raised internally and by Congress, the states and the

water industry about whether OGWDW's regulatory priorities are commensurate with health risks. OGWDW's diminishing resources to develop and implement EPA regulations are also causing concern. In addition, there is some question about adequate scientific findings to support regulation development.

Some of the project's goals include establishing sound science to support regulation development; developing regulations focusing on contaminants posing the greatest public health risks; watershed control; and encouraging strong, flexible partnerships

with state and local governments in implementing EPA rules. The draft redirection plan will be released shortly for public review and comment.

Partnership

In March 1995, the EPA inaugurated a new voluntary program, termed "Partnership for Safe Water;" to enhance public-health protection. Under this program, managers would evaluate the operation of their water-treatment systems and make the necessary improvements.

The partnership was developed by the EPA, state water-supply agencies (Association of Safe Drinking Water Administrators), and the water industry (American Water Works Association, Association of Metropolitan Water Agencies, AWWA Research Foundation and National Association of Water Companies).

System managers who join the program will evaluate their treatment-plant performance, operating and maintenance procedures, operator training and management practices by applying EPA-developed criteria. System managers will then use the information to develop and implement improvement plans. The final step will include an impartial third party to evaluate the effectiveness of the improvements.

The plan will help the EPA and the water industry improve safeguards for surface-water supplies against the protozoan *Cryptosporidium* and other pathogens. So far, about 300 surface-water systems that serve a total of about 90 million people have signed up for the partnership.

Coordination

Interagency efforts to respond to the challenge of new microbiological information and to develop guidelines on recent microbial issues associated with drinking water have expanded. Some interagency collaboration involving OGWDW has occurred for many years. For decades, the EPA and the Centers for Disease Control and Prevention have jointly collected data and published national waterborne disease-outbreak statistics.

In 1994, the EPA and CDC expanded their cooperation. In one joint effort, the two groups researched and issued joint guidelines regarding how long the public should boil drinking water if a water system issues a boil-water advisory. The guidelines state that people should boil water for one minute. For individuals living at higher than 2 kilometers altitude, they should boil it for three minutes because of

EVOLUTIONARY CHANGE

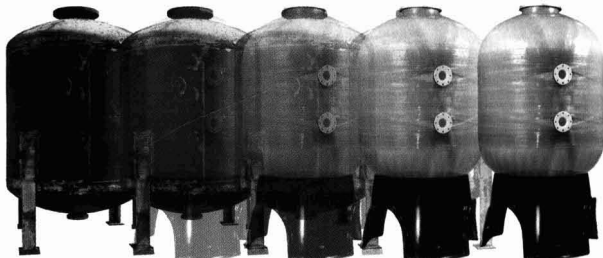

In Pressure Vessels

Value-added features of Composite Pressure Vessels:

- ASME code option.
- No relining, painting or costly maintenance.
- No corrosion.
- Higher strength than steel, but lighter weight.
- Full-featured with Manways, Flanges, Sight Glasses, Lifting Lugs, etc.
- Five-year warranty.
- Quick EIGHT-DAY shipments.

Isn't it time *your* system evolved?

STRUCTURAL
NORTH AMERICA

The leader in Composite and Fiberglass Tank Technology

Industrial Parkway • Chardon, OH 44024 U.S.A. • TEL: 216-286-8265 • FAX: 800-942-7659

The SuperEH&S™

disc is here!

For Windows®,
Windows 95®
& Macintosh®

FOLIO
INFOBASE

*The complete EH&S regulatory and
legal library on a single monthly CD-ROM.*

Now you can have all the updated federal & state EH&S information you'll need on one convenient disc. With this portable library, your research will be faster and easier than ever.

Only Counterpoint's **SuperEH&S** disc gives you fingertip access to complete federal and state EH&S regulations and statutes, and much more.

You'll find accurate easy-to-read tables and instant hyperlinked access to cross-referenced citations. Latest Folio™ search software makes this disc fully compatible for Windows, Win95 and Macintosh platforms. And it's fully networkable.

The single-disc solution.

Each SuperEH&S disc includes:

- Complete CFR for EPA, OSHA, DOT and relevant sections from other titles – updated from the daily Federal Register
- U.S. Code - annotated and updated EH&S statutes
- Complete daily Federal Register, latest month
- Federal Register history - five years of EPA, DOT and OSHA articles from 1990 to present
- The most current and comprehensive state regulations available for all 50 states (priced separately)

COUNTERPOINT
PUBLISHING

800-998-4515

84 Sherman Street, P.O. Box 928, Cambridge, MA 02140
<http://www.counterpoint.com>

A one-year subscription includes 12 monthly updates.

With your SuperEH&S order, you'll get 12 comprehensive CDs with all software upgrades, documentation and toll-free technical support.

Compare the utility, ease-of-use and value of the SuperEH&S disc with any similar product. You'll see why Counterpoint sets the standard for electronic regulatory products.

We're so sure you'll be satisfied with the SuperEH&S disc, we offer a risk-free 30 day guarantee. Call 800-998-4515 today for more information.

SuperEH&S Disc Introductory Special Offer:

With your annual subscription order, we'll include a **FREE Panasonic portable CD-ROM player** for your

computer, a \$399 value (while supplies last). This SCSI CD-ROM player includes adaptor and cable, installation software, and AC adaptor. Call now to take advantage of this limited-time offer.



All of Counterpoint's federal and state compliance products are available as individual titles or in any combination of titles you choose. Educational discounts are available. Counterpoint is FEDLINK listed.

SuperEH&S is a trademark of Counterpoint Publishing, a Thomson Legal Publishing company. All other trademarks are property of their respective owners.

Circle 13 on card.

Water Quality

the uncertainty about virus survival at the lower boiling point at high altitudes.

Most of the expanded coordination between the EPA and CDC and other agencies involves *Cryptosporidium*. Initially, the closer cooperation was driven by water-industry concerns about what to tell the public if the pathogen was detected in filtered water as the result of EPA-required monitoring.

The concern stems from data that suggests that *Cryptosporidium* is common in source water, has often been found in filtered water and has a much greater resis-

tance to disinfection compared to other pathogens. This situation indicates that any *Cryptosporidium* penetrating the filter would expose the public to some risk of infection, ranging from zero (if the organisms are dead and noninfective to humans) to some as-yet-undefined higher level.

In June 1995, the EPA and CDC prepared and jointly released guidelines that discussed what those with weakened immune systems might do to protect themselves from *Cryptosporidium* in drinking water. This organism causes them more severe and more persistent symptoms than

in otherwise healthy individuals. The Food and Drug Administration also contributed, primarily in connection with bottled water, for which they have responsibility.

The guidelines suggested that individuals with severely weakened immune systems who wish to take extra precautions boil their drinking water for one minute. The guidelines also indicated that certain types of bottled water and point-of-use filters provided reasonable protection, although perhaps not the absolute protection that boiling water would.

Recently, EPA personnel attended a meeting held on *Cryptosporidium* sponsored by the U.S. Department of Agriculture and AWWA. The primary purpose of the meeting was to begin closer coordination and collaboration between the groups in planning and conducting *Cryptosporidium* research. An important point made was that other countries needed to be included, especially the United Kingdom, which has a large *Cryptosporidium* research program.

Emerging Pathogens

The SWTR regulates *Giardia* and total viruses with a treatment standard. In other words, treatment filtration and disinfection must reduce *Giardia* and virus densities by three and four logs, respectively. The TCR controls many bacterial and viral pathogens by controlling the indicator organism, coliforms.

But other organisms are being newly recognized as pathogens and identified as actual or potential waterborne-disease agents. The most widely known among these is the protozoan *Cryptosporidium*. This organism recently caused a number of waterborne-disease outbreaks in the United States and other countries. In 1993, a massive waterborne outbreak of cryptosporidiosis occurred in Milwaukee, Wis., which resulted in an estimated 403,000 gastrointestinal illness cases.

Other recently recognized protozoal agents of waterborne disease include *Cyclospora*, *Toxoplasma* and microsporidia. *Cyclospora* has caused several recent outbreaks of prolonged gastrointestinal illness in the United States and other parts of the world. *Toxoplasma* is a common infection of birds and mammals, especially cats.

An outbreak in 1995 in Victoria, British Columbia, which infected up to 3,000 residents, has been linked—though not conclusively—to drinking water. Microsporidia have caused chronic diarrhea in

THE WINNER!

This MMC groundwater monitoring tape wins hands down in every category.

Wins for accuracy. Electronic sensor accurate to $\pm 1/8$ inch (± 3 mm).

Wins for repeatability. Steel tape means no stretch. Meets U.S. Government Specification #GGG-T-106E.

Wins for simplicity. Sensor emits steady tone for floating hydrocarbons, an intermittent sound when it touches water and a return to steady tone for hydrocarbons heavier than water.

Wins for durability. Built tough, top to bottom. Tape encapsulated in polyethylene to protect extruded conductors. A heavy molded carrying case protects unit during transport.

Wins for affordability. This state-of-the-art unit is yours for under \$1,900.

Phone or fax for full information.

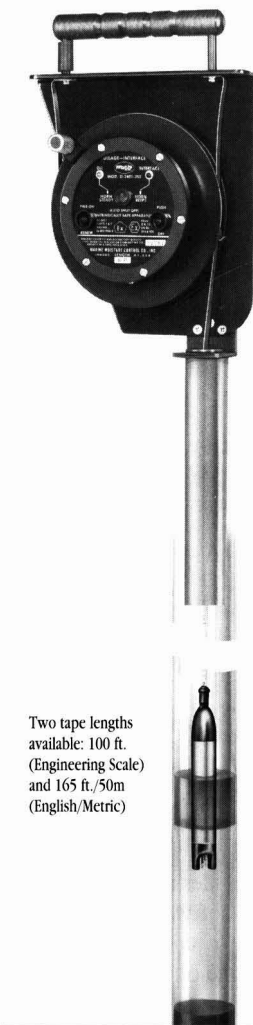

Two tape lengths available: 100 ft. (Engineering Scale) and 165 ft./50m (English/Metric)

MMC International Corp.

60 Inip Drive, Inwood, New York 11096-0664 U.S.A.

Phone: 1-800-645-7339 • 1-718-327-3430 • 1-516-239-7339 • Telex: 96-0140 MAMCAF INND • Fax: 1-516-371-3134

AIDS patients and potentially could be waterborne.

The bacterium *Helicobacter pylori* has been implicated as a cause of peptic ulcers, gastritis and gastric carcinoma. The route of transmission apparently includes water.

Another newly recognized agent, the hepatitis virus, has caused waterborne-disease outbreaks in developing countries, but no outbreaks caused by the virus have yet been identified in the United States.

In about half the reported U.S. waterborne-disease outbreaks, the causative agent was not identified. Thus, it is likely that other microbial agents of waterborne disease will eventually emerge as waterborne pathogens. The EPA plans to conduct research on some of the emerging agents to determine whether additional safeguards are needed to protect the water supply.

In addition, the EPA is conducting or plans to conduct research on the risk and water-treatment-control measures associated with several opportunistic bacterial pathogens that have been shown to grow in biofilms on the inner surface of distribution system pipes. The opportunistic pathogens, which may cause health effects in those with weakened immune systems but typically not in healthy individuals, have been linked at least tenuously with waterborne disease.

Among this group are *Pseudomonas aeruginosa*, *Aeromonas hydrophilia* and *Mycobacterium avium* complex. This group is drawing greater attention as the result of sizable increases in the population with impaired immune systems, including AIDS patients, the elderly, infants and others.

These new developments in the drinking-water program are not the only steps being taken to respond to conflicting pressures. However, they are among the most important. Changes in EPA program emphasis and improvements in coordination and communication offer hope for delineating and achieving the most meaningful drinking-water program. **EP**

Paul S. Berger is the senior microbiologist with the EPA OGWDW in Washington, D.C.

**Coming In February's
Environmental Protection**

**Dip into the latest in water
and wastewater chemicals.**

OZONE

- **Disinfection**
- **Advanced Oxidation**
- **Organic Destruction**

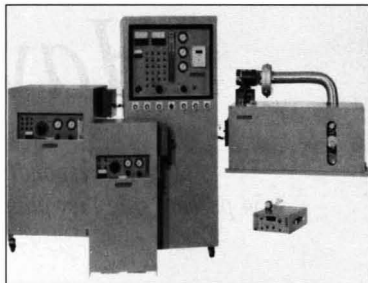

Ozone, the strongest commercially available oxidant is produced on site for your critical water and waste water treatment applications. Ozone Research & Equipment offers complete systems including ozone generators, monitors, contactors, catalytic ozone destructors and control options to meet the toughest applications. Low cost, dependable, easy-to-install systems, backed by corporate strength and national/international service. For information on pilot studies, rental equipment, financing programs or technical assistance based on 35 years of experience, **Call (800) 321-8200**

Experience the Results!



OZONE RESEARCH & EQUIPMENT
4953 West Missouri Avenue
Phoenix, AZ 85301-6100 USA
Phone (602) 931-7332
Fax (602) 931-7727

Circle 15 on card.

SEPARATION ANXIETY?

**Solutions & Systems for
Centrifugal Liquid-Liquid Separation**

Dewatering

**Oil Spill
Recovery**

Separation

**Water
Clean-up**

**Solvent
Extraction**



**Up to
200 GPM**

**Outputs are
>99% Pure**

**Liquid/Liquid
Ratios
<5% to >95%**

**Patented
Technology**

**Extremely
Cost-Effective**



1125 Business Center Circle • Newbury Park, CA 91320
408 Cripple Creek Road • Cedar Park, TX 78613

CALL TODAY TO ORDER



YOUR FREE VIDEO

For information, a demonstration, or video call: 1-800-380-CINC

Our Readers Have Spoken

Of those responding to an Environmental Protection survey, 54 percent said they planned to increase environmental spending in 1996.

By the EP Staff

When we wanted to find out what you, the readers of Environmental Protection, planned to purchase in 1996, we didn't beat around the bush or do some type of highfalutin study. We took the plain and simple route—we just asked you.

In both the October and November issues of Environmental Protection, we included questionnaire cards asking about your buying intentions for 1996. The responses were tabulated by Standard Rate and Data Service.

Of those filling out the card, 41 percent said they were in the consulting or construction business, 34 percent said they were in manufacturing and 25 percent said they were involved with municipal wastewater treatment plants and utilities.

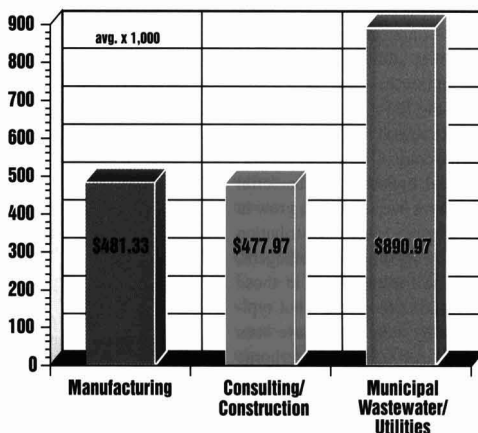

Average Budgets for 1996

Percent of Environmental Budget Devoted to:

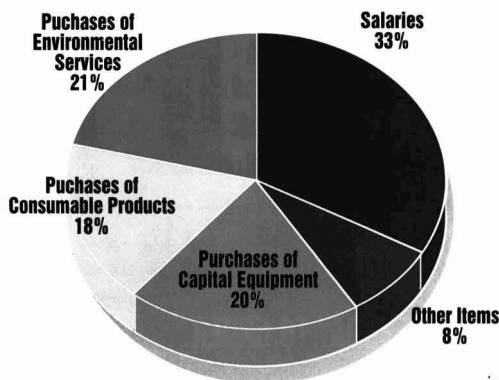

From the questions we posed, we were able to paint a picture of what the coming year looks like in terms of environmental budgets and purchases. What we can't predict are the impacts of several pending congressional actions, such as renewal of the Clean Water Act, the Safe Drinking Water Act and the Endangered Species Act; Superfund reauthorization and reforming portions of the Clean Air Act.

Regardless of how the legislation shakes out during the coming year, respondents said they intend to increase their environmental spending in 1996 compared to 1995. Of those responding, 54 percent said they would increase spending, 36 percent said their spending would remain the same and 10 percent said they would cut spending.

**Respondents' 1996 Budgets
Expected to:**

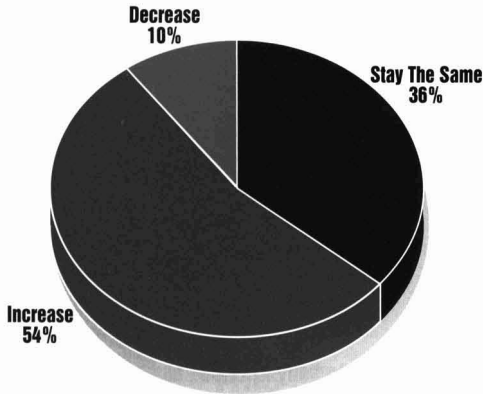

Based on responses to the survey, the average environmental budget for municipal wastewater treatment and utilities is expected to be \$890,970 this year. For the consulting and construction industries, the average environmental budget is \$477,970, and for manufacturing, it's \$481,330, based on the survey results.

The environmental budgets also can be broken down as to how the money will be spent. As in many other businesses, salaries take the largest chunk of our readers' environmental budgets, accounting for 33 percent, based on the survey responses. Purchases of environmental services account for 21 percent of the budget, while capital equipment purchases account for 20 percent and consumable product purchases for 18 percent. The remaining 8 percent go to "other items."

And what types of goods and services do readers intend to buy? Based on our survey, environmental consulting services will be in top demand, followed by personal protection equipment, hazardous material transportation services, protective clothing and respirators. Rounding out Environmental Protection's list of Top 10 products for 1996—it's actually the top 11 products because of a tie—are spill cleanup products, pH meters, test kits, hazardous waste containers, pumps and wastewater treatment chemicals.

Respondent Profile

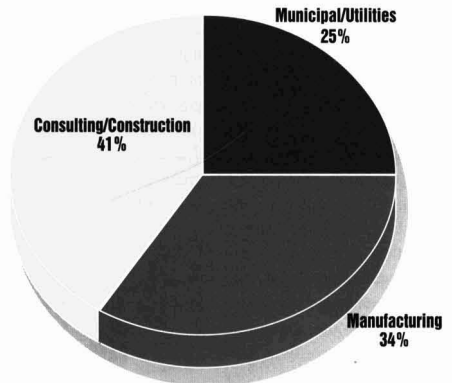

Top 20 Products For Purchase In 1996

- | | |
|---|---|
| 1. Environmental Consulting Services | 12. (Tie) Wastewater Treatment Chemicals |
| 2. Personal Protection Equipment | 13. (Tie) Software, Environmental Management; |
| 3. Hazardous Material Transportation Services | 14. Software, EPA/OSHA Compliance |
| 4. Protective Clothing | 15. Wastewater Treatment Equipment |
| 5. Respirators | 16. (Tie) Groundwater Treatment Systems; |
| 6. Spill Cleanup Products | 17. Software Training Seminars/Materials |
| 7. pH Meters | 18. Remediation Services |
| 8. Test Kits | 19. Oil/Water Separators |
| 9. (Tie) Hazardous Waste Containers; | 20. (Tie) Filtration Equipment; |
| 10. Pumps; | 21. Soil Sampling Equipment |

Guarding Against Odors

An enhanced hypochlorite scrubbing process helps fight odors and low-level VOCs in gas streams.

By Edmund H. Stitt, Keith Kelly, Anthony R. Elgood and Martin E. Fakley

Many technologies are available for removing odorous compounds from gas effluents, including thermal and catalytic oxidation, adsorption, adsorptive oxidation, and chemical or biological oxidation. In general, the thermal oxidation processes are expensive at low odor or volatile organic compound concentrations, while the adsorptive techniques are costly at anything above low VOC/odor rates. The treatment regime between the two is dominated by biological and chemical oxidation.

Chemical oxidation enables the treatment of large quantities of odor- or VOC-laden gases to be treated economically and in a limited space. Sodium hypochlorite is most frequently used. It is relatively inexpensive and has a high oxidation potential. It will oxidize a wide range of compounds, most of which are encountered in odor streams.

Conventional hypochlorite (or bleach) scrubbing, however, presents several problems. The autogeneous oxidation reaction can be slow, requiring long residence times, large equipment and high hypochlorite concentrations. Hypochlorite at high concentrations has a tendency to chlorinate

some compounds—ammonia, amines and phenols—leading potentially to different odors and toxins. If the pH is allowed to fall, hypochlorite can decompose to produce chlorine and it will be emitted with the vent gas.

These difficulties lead to the development of the three-stage scrubbing process for odors. The stages were dilute sulfuric

Chemical oxidation enables the treatment of large quantities of odor- or VOC-laden gases to be treated economically and in a limited space.

acid for amines and basic odors, alkaline sodium hypochlorite for the main oxidation and dilute sodium hypochlorite to remove any chlorine emitted in the second stage. Although capital costs for the three-stage installation are relatively high, the process works well and is still widely used. Chemical consumption, especially hypochlorite, is considerable and the maximum odor removal is about 95 percent.

The Odorgard process was pioneered by ICI Katalco and Dr. F.H.H. Valentin.

Efficient chemical scrubbing was combined with a catalytic reaction of the recirculating scrubbing liquor, leading to enhanced performance.

Process Chemistry

Various heavy metals catalytically promote the decomposition of sodium hypochlorite into gaseous dioxide and sodium chloride.

ICI Katalco developed the Hydecats process, a promoted nickel oxide heterogeneous catalyst for the decomposition of sodium hypochlorite in waste streams. Reformulations of the Hydecats catalyst have proven adept at using reactive surface oxygen from the initial decomposition of hypochlorite to oxidize organics in the aqueous phase.

Oxidation of many compounds, including sulfides, amines, amides, aldehydes, ketones, phenols and carboxylates, has been observed in the laboratory. Also observed were chlorinated, unsaturated and aromatic hydrocarbons.

Use of the above catalytic properties in a hypochlorite scrubbing operation leads to an increase in oxidation reaction rates, allowing suppression of side reactions. The problems with conventional hypochlorite scrubbing can be reduced, or with proper design, minimized. This prevents acidic prescrubbing and caustic postscrubbing.

Valentin successfully employed through

Aquastore®/JetMix™ Report

Engineer: Robert E. Lee & Assoc., Green Bay, WI

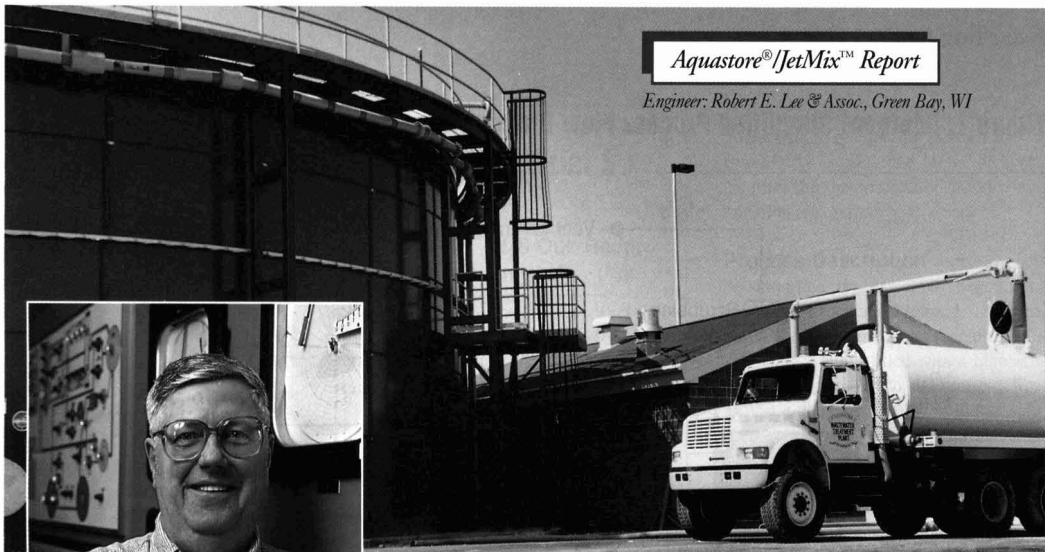

“This sludge storage and mixing system is a key part of our successful land application program.” Jim Krueger, Plant Supt./Denmark, WI

Sludge disposal options were finalized in 1993 with EPA regulation 40CFR 503 which mandated the following sludge management practices: land application, land filling and incineration.

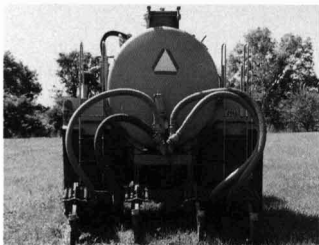

Denmark, Wisconsin chose land application of sludge because it was the best fit for their operation and also gave area farmers an inexpensive source of fertilizer.

For the land application option to work for Denmark, sludge had to be stored for up to six months because

of their northern Wisconsin location. Storing 7% - 8% solids sludge for up to six months is not difficult, however, pumping it out at the end of that time required that sludge be mixed so it could be pumped into land application vehicles.

The estimated energy cost to continuously mix the stored sludge was prohibitive which led to the selection of the JetMix sludge storage and mixing system designed and supplied by Great Lakes Aqua Sales and Service. Krueger reports he turns on the powerful mixing pump only three to four days before sludge is discharged to land application vehicles. This system uses three adjustable nozzles on the bottom of the 70' diameter x 24' high Aquastore® tank.

Krueger says, “This JetMix sludge system thoroughly mixes sludge prior to disposal, providing uniform sludge consistency for proper land application.”

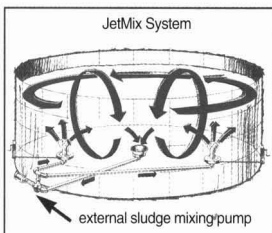

A.O. Smith Harvestore Products has focused its resources on meeting the needs of those municipalities who are considering land application of sludge. A.O. Smith Harvestore Products, its authorized, independent dealers and Great Lakes Aqua Sales and Service are available to work closely with your engineers to provide an efficient and reliable solution for sludge storage.

For the full story on the Denmark sludge storage and mixing system, call or write today for Case History No. 294.

The JetMix sludge mixing system is designed and supplied by Great Lakes Aqua Sales and Service, Inc.

Aquastore is the registered trademark of A.O. Smith Harvestore Products, Inc.
JetMix is the trademark of Great Lakes Aqua Sales and Service, Inc.
©Copyright 1994, A.O. Smith Harvestore Products, Inc.



Permaglas®
Storage Systems
AQUASTORE®
Tank Systems

A.O. Smith Harvestore Products, Inc.
Municipal/Industrial Department
345 Harvestore Drive
DeKalb, IL 60115
815/756-1551
FAX: 815/756-7821

Circle 17 on card.

Figure 1: Odorgard Simplified Process Flow Diagram

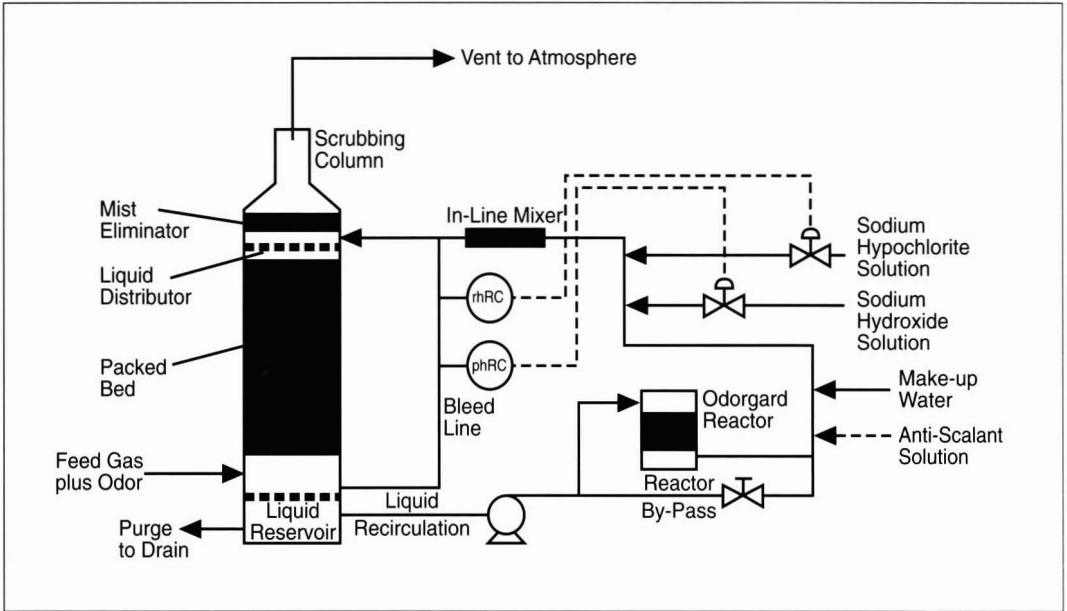

Get Instant Pre-Phase I Environmental Information From Your Desktop PC...

Announcing ERIISnet: The Industry's Only Real-Time Pre-Phase I Online Environmental Information Service...

While your competitors are still waiting days to get their pre-Phase I environmental regulatory records reports from someone else, you can get more projects done, faster, by tapping the full range of all available environmental data for any site in the US—instantly, 24 hours a day, with the new **ERIISnet** online service from ERIIS!

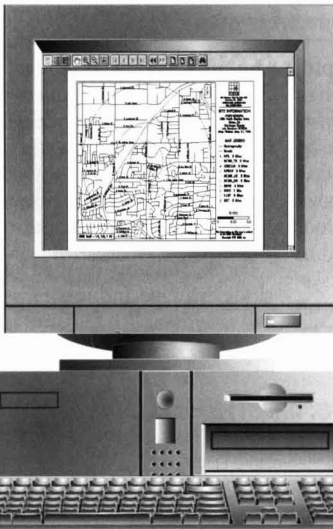

■ **It's Fast:** Get all the Federal, state and local records information you need to complete your Phase I site assessments—whenever you need it in seconds, for any site in the US—at the lowest prices in the industry...all you need to do is enter your site's address;

■ **It's Flexible:** Screen any number of sites and access any part of our database, at any site, zip or radius you select. Get as much or as little property information as you need—in seconds, not days. With **ERIISnet**, you're in control;

■ **It's Affordable:** No added connect time or long distance phone charges—pay only for what you need. Reports through **ERIISnet** are *less than the price of conventional paper reports*, and there are no express charges.

Accessing and using ERIISnet is as easy as clicking your mouse, with your ERIISnet Windows access software, provided **FREE**... **Special Bonus:** Complete the agreement in your **FREE ERIISnet** access kit and get two online pre-Phase I reports, **FREE**—a \$284 value.



ERIISnetTM
Online Environmental Property Information

1-800 989-0402

To get your **FREE** ERIISnet subscription package—Call:

A Service of Environmental Risk Information & Imaging Services (ERIIS)

505 Huntmar Park Drive, Suite 200 ■ Herndon, VA 22070 ■ (703) 834-0600

FAX (703) 834-0606 ■ E-mail: eris@ibm.net

Compuserve: 71154,2115

Table 1: Odorgard Pilot Plant Data - Trial S

Sample	Odor In (OU/m ³)	Odor Out (OU/m ³)	Redn. (%)	H ₂ S In (mg/m ³)	H ₂ S Out (mg/m ³)	Redn. (%)
1	183,000	4,400	98	49,000	44	99.9
2	477,000	2,900	99	2,000	19	99.1
3	546,000	7,500	99	10,000	39	99.6
4	55,000	300	99	88,000	82	99.9

*Gas rate 3,600 m³/hr and liquid rate 50 m³/hr.
Odor numbers are results from Olfactometric tests.
Hydrogen sulfide measured by Jerome meter.*

the 1980s a dispersed hydrated nickel-peroxide catalyst (about 25 parts per million nickel in the recirculating liquor) in a number of installations in the United Kingdom. Removal efficiencies of up to 98 percent were achieved in a single stage.

However, this resulted in nickel contamination of the liquid outfall. The dispersed catalyst was not selective and promoted decomposition to O₂ and NaCl, leading to inefficient use of hypochlorite.

The Odorgard process is a combination

of this scrubbing process and an ICI proprietary fixed-bed catalyst. The catalyst is formulated to minimize losses of hypochlorite, and the problem of nickel contamination is removed.

Process Description

A simplified process flow diagram for Odorgard is shown in **Figure 1**. The odorous (or VOC-laden) gas passes through a scrubbing column filled with a high efficiency packing, in counter-current flow against a dilute alkaline hypochlorite solution. It then travels through a mist eliminator to the stack. The odors are absorbed into the aqueous phase.

Some ionic and autogenous reaction occurs. The liquid leaving the tower is passed through the fixed catalyst bed reactor. The absorbed organics and odor compounds are oxidized catalytically by the hypochlorite. Catalyst volumes are not large—typically 10 to 200 liters.

The caustic and hypochlorite levels of the liquid are adjusted on pH and redox control levels, respectively, and the liquid is returned to the top of the column. The control system is able to respond to varia-

Have the tough job done...

...before you head out!



New for
1996

With the new **Well Sentinel LTM3100** you can pre-program up to 16 tests before you leave the office. Our Windows-based **Win-Situ** software runs the LTM3100, making it easy to preprogram linear, logarithmic or event-based tests, and graph and print data. The LTM3100 is a four-channel data logger, which means you can log pressure, temperature, conductivity and pH data simultaneously. The weatherproof LTM3100 is designed for long-term installations, but it is also ideal for multi-well tests. It can be mounted inside a standard 4-inch well casing for security.

Before you head out, call us at **1-800-446-7488** to find out how the Well Sentinel LTM3100 can help with your application.



In-Situ Inc.

Helping monitor the earth's resources

210 S. Third Street • P.O. Box 1 • Laramie, WY 82070 • Tel: 307-742-8213 • Fax: 307-721-7598

AIR FORCE TOP GUNS

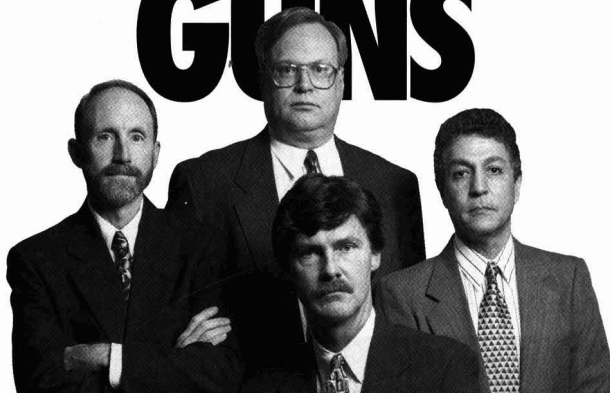

Led by Gale Hoffnagle (center rear), Jim Serne, Mike DeBusschere and Hassan Gomaa (l to r) are the new Top Guns in TRC's Air Force.

To maintain a front-line position in any business you've got to recruit good talent. The real professionals. The aces. The best.

At TRC, we've got a technical team that leads the industry in CAAA compliance strategy. We call it the Air Force. And we just signed on three new senior level air quality scientists with major permit management experience. We call them the Top Guns.

Jim Serne. Mike DeBusschere. Hassan Gomaa. From pulp and paper to bakeries to refineries to regulatory agencies, these guys have been there, done that. Under the direction of Gale Hoffnagle, they now lead our air quality services throughout the country.

Do you need your permits to be flexible, accurate, complete and on time? Do you want a true partnership with experienced people? Call 1-800-TRC-5601. Get the Air Force. Get the Top Guns. And get a free copy of our handbook on the Clean Air Act Amendments. Get the best.

TRC Environmental Corporation

Offices located in major industrial centers throughout the U.S.

Call 1-800-TRC-5601

Guarding Against Odors

tions in the odor/VOC loading.

Hypochlorite requirement—the major component of operating costs—is directly related to the average duty, not the design or “peak” duty. A small liquid purge is taken from the liquid to control salt concentration in the liquor. Liquid inventory is sustained by a water makeup and anti-scalent used to protect the catalyst.

Pilot Plant Data

The ICI pilot unit is designed to treat 3,600 cubic meters of air per hour. The scrubber is 1.2 meters in diameter, with 2 meters³ packed volume. The liquid recirculation rate is 20 to 50 m³/hr, and the catalyst volume is 15 liters.

The reagents used are 15 weight per weight percent NaOCl and 18 weight per weight percent NaOH. The organosulfide levels on the inlet and outlet gas are continuously monitored.

Table 1 shows data obtained using the ICI pilot unit on a sewage treatment works. Treated air drawn from the works included sludge thickening tanks and a press house. During the 13-day trial, the daily time-averaged H₂S profile was 20 hours at 5 ppm and 4 hours at 40 ppm. The latter, with a liquid recirculation rate of 50 m³/hr. The pH set point was 9.2 and the oxidation reduction potential set point varied throughout the trial between 300 and 700 millivolts.

Throughout the trial, the gas stream contained sulfide levels of up to 80 ppm, and was consistently treated to less than 0.02 ppm. Organosulfide-removal efficiencies rarely fell below 99.5 percent. The site had previously employed a bio-scrubber with a downstream bio-filter to treat the foul air.

The operating company had experienced severe problems with the units since installation. After the trial, the bio-scrubber was successfully retrofitted as an Odorgard unit.

There are 16 units successfully installed in the United Kingdom. They consist of a mixture of retrofits and newly built units, varying in size from 3,600 to 140,000 m³/hr. They are used in a wide variety of industries including meat rendering, metal foundries, paint manufacturers, water and sewage, fine chemicals, food and spice processing, and leather tanning. **EP**

Keith Kelly is product manager for Odorgard™. Edmund H. Stitt is senior process engineer; Anthony R. Elgood, process engineer and Martin E. Fakley, business manager—all with Oxispec™ of the United Kingdom.

Carbon Injection Proves Effective In Removing Dioxins

The technology, which is widely used in Europe, is beginning to take hold in the United States.

By Douglas R. Roeck and Alfred Sigg

During the past several years, there has been growing concern about emission of polychlorinated dibenzo-p-dioxins and polychlorinated dibenzofurans (PCDDs/PCDFs). Dioxins and related compounds are byproducts of combustion formed by recombining other organic constituents and chemical reactions in the combustion effluent-gas stream.

Generally, dioxins are formed in the cooler regions of the combustion system, where condensation onto fly-ash particles can occur. Certain metals can also act as catalysts and promote dioxin formation.

Much of the attention concerning PCDDs/PCDFs has focused on hazardous-waste combustion facilities. Actually, incinerators are a relatively minor contributor to the overall dioxin/furan environmental burden compared to medical and municipal waste combustors.

In Europe, carbon injection is widely used to effectively control dioxin emissions from hazardous-waste incinerators. The technology is beginning to take hold in the United States.

Waste Technologies Industries, a hazardous-waste incinerator in Ohio, recently completed extensive testing of the effectiveness of carbon-injection technology.

The System

Though the firm operates one of the

country's newest hazardous waste rotary kilns in East Liverpool, Ohio, the basic system design isn't unique. It houses a well-engineered assembly of traditional unit operations coupled with combustion process design and control for minimizing formation of NO_x, CO, SO₂ and total hydrocarbons, as well as PCDDs/PCDFs. The incinerator train consists of a rotary kiln followed by a secondary combustion chamber and a waste-heat boiler.

Capable of handling drums, bulk solids, liquids and sludges, the system is permitted to feed up to 2,000 pounds per hour of chlorine. The flue-gas cleaning system (FGCS) is comprised of a spray dryer, a three-field electrostatic precipitator (ESP), and a four-stage wet scrubber that includes a quench section, two packed bed sections and a venturi scrubber section.

The enhanced carbon injection system (ECIS) is now an integral part of the FGCS. Pollutants such as HCl and SO₂ are controlled primarily by the wet scrubber portion of the FGCS, while particulate matter and heavy metals are effectively removed by the ESP and venturi scrubber and the activated-carbon injection system.

The system uses Calgon Carbon-type WPX, a powdered activated carbon produced from reactivated granular coal-based carbons. Once the powdered carbon is injected into the system and has adsorbed dioxins and other contaminants, it is removed along with particulates and other solids in the ESP. The material is then dis-

posed of with other plant solid wastes in an off-site landfill.

Evaluating Carbon Injection

Three months after the initial trial burn, the firm began a program to evaluate using activated-carbon injection for controlling dioxin emissions. More than 60 stack sampling runs were conducted before and after the installation of the carbon-injection system to determine emission rates for PCDDs/PCDFs.

Data presented in the following charts are based on sampling runs conducted in accordance with the Environmental Protection Agency's Method 23. Emissions have been evaluated based on total homologue groups (PCDDs/PCDFs or D/Fs) and on a total toxic equivalency (TEQ) basis using the 1989 EPA/international toxic equivalency factors. A comparison of average results before and after employment of carbon injection for total PCDDs/PCDFs and total TEQs is shown in **Table 1**.

The carbon-induction system is more than 95 percent effective in reducing total dioxin emissions. The ratio of total PCDDs/PCDFs to total TEQs from the control system changed, going from about 55 to 75 and indicating that the more toxic cogener groups are controlled more effectively than all groups combined. This is shown in the table for 2, 3, 7, 8-TCDD and 2, 3, 7, 8-TCDF where average efficiencies were 99.6 percent and 97.4 percent, respectively.

The extensive amount of emission data



REMEDICATION SOLUTIONS THAT WORK

HLA provides proven site remediation solutions—solutions that work for our clients, for the environment, and the community.

Over 30 years of site restoration experience has resulted in the completion of thousands of environmental projects throughout the country. Our services include:

- Remedial investigation & feasibility studies
- Remedial design & action
- Hazardous & solid waste management
- Air quality management
- Human health & ecological risk assessments

With offices throughout the United States, Australia, and in Mexico, we're dedicated to finding cost-effective solutions that meet our clients' needs. Solutions that work.



**Harding Lawson
Associates**
Engineering and
Environmental Services

Call toll free: (800) 578-0821

Case Study: Carbon Injection

TABLE 1
Selected Emission Results Before and After Installation

Emission Parameters	Pre-Control Data	Post-Control Data	Relative Efficiency (a)
Total PCDDs/PCDFs ng/m ³ @ 7% O ₂	133	6.0	95.5%
Total TEQs ng/m ³ @ 7% O ₂	2.4	0.083	96.5%
Ration of Total D/Fs: TEQs	54.9	75.0	N/A
2, 3, 7, 8 - TCDD, pg/train	107	0.4	99.6%
2, 3, 7, 8 - TCDF, pg/train	904	24	97.4%
1, 2, 3, 7, 8 - PeCDD, pg/train	483	10	97.9%
2, 3, 4, 7, 8 - PeCDD, pg/train	3,645	138	96.2%

(a) The efficiency based on average data prior to and after ECIS installation

also permitted an in-depth analysis of potential correlations with other system operating parameters. With respect to both chlorine input to the system and kiln operating temperature, the data showed only a modest correlation with kiln outlet temperature (prior to installation of the ECIS).

Emission data, as a function of chlorine feed on a total D/F and total TEQ basis prior to ECIS installation, showed no discernible pattern. These data represent a small window of chlorine feed ranging from about 2,800 to 3,200 pounds per hour.

Similarly, emissions have been evaluated as a function of kiln-outlet temperature both before and after installation of the carbon system. Before the use of the carbon injection, emissions showed a tendency to increase with kiln-outlet temperature. After installation of the ECIS, no temperature correlation was seen, probably due to the fact that emission had been reduced to such a low level. The lack of distinct correlation with furnace operating conditions can be interpreted as further indication that dioxin and furan emissions are largely dependent on design and operating parameters associated with FGCS.

Mercury-Emission Control

The use of carbon injection has also improved mercury-emission control. At the time of the original trial burn—at a feed rate of 2 pounds per hour—mercury removal was 7 percent. This low removal efficiency was partially due to excessive spiking of mercury into the scrubber neutralization system. Tests conducted with the carbon

system in operation at a feed rate of only 0.12 pound per hour of mercury showed 97-percent removal efficiency.

Proven Effective

The use of carbon injection at the rotary-kiln incineration facility was shown to be more than 95 percent effective in removing dioxin emissions from the flue-gas stream. For 2, 3, 7, 8-TCDD, emissions were reduced by more than 99 percent. Before using carbon injection, annual emissions (on a total TEQ basis) were equivalent to about 1.85 grams per year, assuming full-time operation. With the ECIS operating, emissions were equivalent to about 60 milligrams per year.

Dioxin emissions have been shown to be independent of chlorine feed to the incinerator, both before and after installing the ECIS. Without carbon injection, dioxin emissions were modestly dependent on kiln-outlet temperature. Since ECIS use, no such temperature dependence was seen.

Capital investment costs for carbon-injection technology average several hundred thousand dollars. The technology provides an attractive alternative to other processes used in Europe, such as fixed-bed or entrainment-process systems, which require a several-million-dollar investment. 

Douglas R. Roeck is manager of hazardous-waste incineration programs with ENSR Consulting and Engineering, Acton, Mass. Alfred Sigg is vice president and general manager of Waste Technologies Industries/Von Roll, East Liverpool, Ohio.



Groundwater Remediation In Less Than 30 Days, For A Fraction Of The Cost, At A Fixed Fee.

**They Said It Couldn't Be Done.
But We Do It Repeatedly.**

QUICK-PURGE® is the fastest and most cost-effective solution for groundwater and soil remediation.

The revolutionary IES QUICK-PURGE® technology uses a geological approach to remediation. It removes contaminants from the subsurface without removing soil and groundwater. Not only is QUICK-PURGE® much faster than traditional methods—it takes just weeks instead of years—but it also does a more thorough job and costs up to fifty percent less. All at a unique fixed-fee contractual rate.

IES developed the QUICK-PURGE® technique to achieve remediation QUICKLY. And to parts-per-billion levels.

They said it couldn't be done. But IES did it. And we can do it for you. For information, call us today.

IES

INTEGRATED ENVIRONMENTAL
SOLUTIONS, INC.

An Inc. 500 Company

3787 Old Middleburg Road, Suite 3
Jacksonville, FL 32210
(904) 778-1188 FAX (904) 778-0201

- Soil & Groundwater Remediation
- Contamination Assessment
- Phase I & II Environment Assessment
- Environmental Consulting
- Government/Regulation Liaison

Using Horizontal Wells as a Remediation Tool

New drilling motors and instrumentation have reduced the cost of horizontal well drilling.

By David L. Russell

The practice of drilling horizontal wells is a relatively old technology from the oil drilling community that is gaining acceptance in the remediation community. New developments in drilling motors and instrumentation technology have reduced the cost of drilling horizontal wells and permit the wells to be used in a number of new applications for remediating pollution-contaminated sites.

Horizontal wells are installed using a variety of equipment and techniques. Selecting the right type of well and drilling equipment used to install the well will depend on the site geology and the type and depth of the contamination encountered. For most applications in the environmental field, the contamination is less than 150 feet deep and the lithology has a horizontal structure.

Some of the advantages of horizontal wells include:

- The ability to steer the well to align it with the principal axis of the contamination plume for efficient recovery.
- The ability to locate the well in any portion of the formation—even along the bottom of the formation—to intercept plume movement and recover dense non-aqueous phase liquids.

- More efficient collection devices for a given aquifer because their developed well length is greater.

The hydraulic advantages of using a horizontal well over a vertical well are:

- The length of developed well in the formation.
- The flow pattern.

These differences are highlighted in

For a given formation, the increase in efficiency is directly proportional to the increase in well length in the formation.

Figures 1 and 2. The greater length of a horizontal well in a formation, when compared to a vertical well, allows greater collection efficiency and utilization.

Where the formation is relatively thin, a horizontal well of 300 feet can be at least six times as productive as a 50-foot vertical well. **Figure 2** illustrates the difference in flow patterns between a horizontal and a vertical well. For a given formation, the increase in efficiency is directly proportional to the increase in well length in the forma-

tion. For example, a 20-foot vertical well is only one-sixth as efficient as a 120-foot horizontal well for a given lithology.

Where the depth of contamination in a formation is less than 20 feet, shallow horizontal wells are often installed from the surface by trenching, pipe jacking or boring. With any of these methods, both the alignment and the depth of the well are quite accurate and subject to the limits of the construction process.

For deeper installations, or situations where buildings, roads, lakes or rivers may prevent access from the surface, other types of horizontal well installation technologies are employed. Horizontal well systems are often classified by the turning radius used in the installation, but the equipment used for the installation of each type of well is quite different.

Types of Drilling Systems

One type of widely used equipment has a long turning radius. This equipment is most commonly used for the installation of pipelines and river crossings. These systems have a turning radius of 1,000 to 3,000 feet and a build angle (rate of change of direction) of between 2 and 6 degrees per 100 feet of length.

A second type of well is the medium-turning-radius well system. These systems

HazWaste WEST

■ Conference & Exhibition

■ Las Vegas

Convention Center
Las Vegas, NV

MAY 21-23, 1996

SUPERFUND



Sponsored by:



E.J. Krause & Associates, Inc.

Waste Age



ENVIRONMENTAL INDUSTRY ASSOCIATIONS

CONFERENCE HIGHLIGHTS:

Hazardous Waste Management Remediation
Innovative Technology Applications Emerging Issues
Plenary Session topic "The Future of Western Remediation"
Special DOD & DOE panel discussions

EXHIBITION:

A Hazardous Waste Exhibition set within WasteExpo's
210,000 net sq. ft. Solid Waste Exhibition

CO-SITED WITH: **WasteExpo'96**

*Spinning our way
to a cleaner future.*

SUPERFUND XVII

HazWaste World

Oct. 15-17, 1996 WASHINGTON CONVENTION CENTER



NEW IN 1996

SFXVII moves to Washington Convention Center
50,000 sq. ft. Hazardous Waste Exhibition
An additional "Solid Wastes Solutions Pavilion" sponsored by Environmental Industry Associations (producers of WasteExpo)

SPONSORED BY:

E.J. Krause & Associates, Inc.



ENVIRONMENTAL INDUSTRY ASSOCIATIONS

MARK YOUR CALENDAR!

PLAN YOUR SCHEDULE!

SUPERFUND XVII

Oct. 15-17, 1996

CONTACT INFORMATION

TO RECEIVE MORE INFORMATION PLEASE COMPLETE THIS FORM AND FAX TO:

E.J. KRAUSE & ASSOCIATES INC.
7315 WISCONSIN AVE., SUITE 450N
BETHESDA, MARYLAND 20814

ATTN: SUSAN NEWMAN

FAX (301) 986-4538 Circle 24 on card.

ANY QUESTIONS CALL (301) 986-7800

HAZWASTE WEST SUPERFUND XVII

I'M INTERESTED IN ATTENDING EXHIBITS CONFERENCE EXHIBITING

COMPANY _____

ADDRESS _____

CITY _____

STATE _____

ZIP _____

CONTACT _____

TITLE _____

TELEPHONE _____

FAX _____

6

Remediation Tools

are the most common in the remediation industry.

One system, developed by Eastman-Cherrington, has a turning radius as short as 300 feet; a 600-foot turning radius is more common. A system developed and used by Drillex has a turning radius of 600 to 1,000 feet. The build angle on these wells is between 6 and 20 degrees per 100 feet.

The third type of drilling system has a turning radius as short as 100 feet. This equipment was developed for the installation of telephone cable and other utilities. The system is suited for wells where the

installed depth is to be less than 75 feet and the length is less than 500 feet.

The medium- and long-turning-radius equipment manufacturers use a downhole motor powered by drilling muds. Some of the companies using downhole motors include Michaels Construction, Eastman-Cherrington and Drillex Environmental Services. Charles Machine Works, Horizontal Drilling Technologies and Utilex Environmental use the shorter-turning, jet-hammer system, which was developed for utility installation

The low-volume, high-pressure jet sys-

tem drills and punches its way through the formation with a hammer. The systems with downhole motors will handle rock, while jet-hammer systems won't. The jet-hammer technology can produce wells up to 500 feet long and can handle depths of approximately 75 feet. The minimum turning radius of the well system is 100 to 200 feet. The jet used to drill the well is steerable, and the location of the well is determined from a surface electronic signal, which is sent from behind the drill head.

The drilling is advanced by pushing the boring pipe. The initial well, when completed, is between 2 and 3 inches in diameter. The well can be enlarged by reaming the hole. The installation accuracy of the well is good. At depths of up to about 30 feet, Utilex reports it can determine where the hole is within about 2 inches. At depths over 30 feet, hole placement is about 2 percent of the depth. (Magnetic and electromagnetic fields interfere with the depth measurements.)

The Drillex system (Drillex Environmental Services) uses a more conventional downhole motor with a rotary bit. The Drillex system also recirculates the drilling muds to bring the materials crushed by the drill head back to the surface, where they are cleaned and pumped back down the drill hole. The drill head is steered by increasing the pressure on steering collars behind the drill head, which exert pressure on the borehole and change direction of the bit.

The Drillex system uses a significantly higher volume of drilling fluids because its system returns the cuttings to the surface, while the Utilex and Charles Machine Works systems force the cuttings into the formation. The Drillex system also uses a downhole magnetic location system that transmits a signal back to the surface. Drillex uses an angle of entry that is among the lowest (between 8 and 25 degrees from the horizontal) and a build angle that is typically about 12 degrees per 100 feet.

According to Drillex, the typical radius of well curvature for its system is 600 to 1,000 feet to allow the completion of the well and insertion and retrieval of tools and the drilling equipment. Drillex acknowledges that, because of its greater radius of curvature, it has a greater distance from the point of entry to the point where the well is truly horizontal (see **Figure 1**). But the firm believes this is a minor price to pay for the completion of the wells.

A fourth system is the Eastman-Cherrington Environmental Services system, which uses a downhole mud-powered

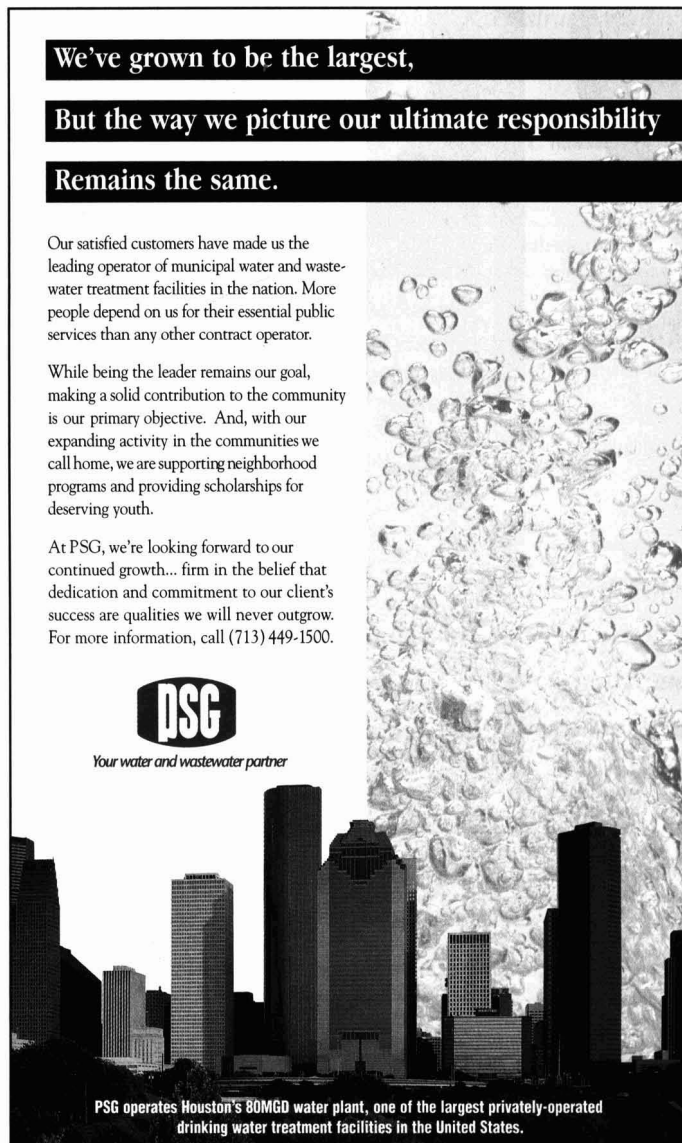

We've grown to be the largest,

But the way we picture our ultimate responsibility

Remains the same.

Our satisfied customers have made us the leading operator of municipal water and wastewater treatment facilities in the nation. More people depend on us for their essential public services than any other contract operator.

While being the leader remains our goal, making a solid contribution to the community is our primary objective. And, with our expanding activity in the communities we call home, we are supporting neighborhood programs and providing scholarships for deserving youth.

At PSG, we're looking forward to our continued growth... firm in the belief that dedication and commitment to our client's success are qualities we will never outgrow. For more information, call (713) 449-1500.



Your water and wastewater partner

PSG operates Houston's 80MGD water plant, one of the largest privately-operated drinking water treatment facilities in the United States.

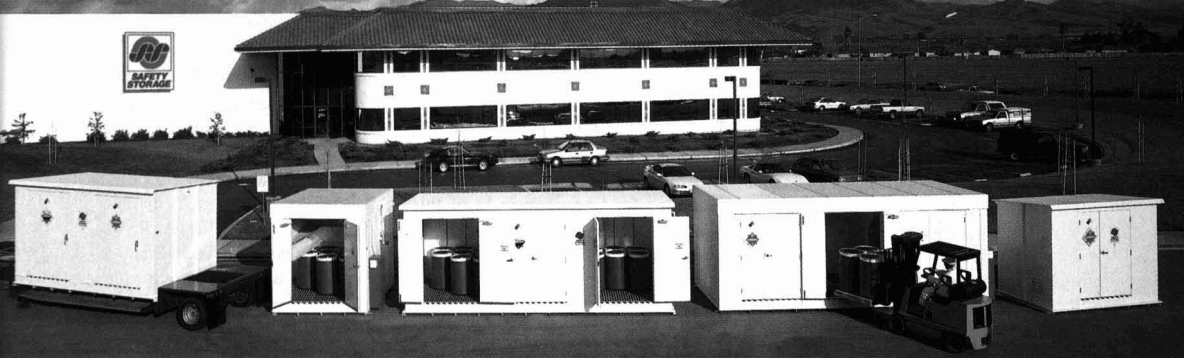

The preferred choice.

Proven hazmat safety at thousands of locations worldwide...



Hazmat storage professionals around the world have found that they can trust us to deliver a quality product and responsive customer support. They know that our broad standard and engineered product

line will give them the flexibility to meet their specific hazardous materials storage, handling, and dispensing needs. They know that when you specify Safety Storage, you get more than just a hazmat building.

First, you get a safe, convenient way to deal with your hazardous materials, reducing your risk and liability. You can be assured of full compliance with all federal, state, and local environmental regulations.

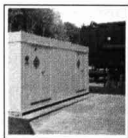

Then, you get our more than 12 years of experience in designing and manufacturing hazmat buildings and lockers, more experience than anyone else in the industry. You get our wide range of engineering and compliance know how. You get quality and cost benefits accruing from our more than 250,000 square feet of manu-



California



Indiana



Mexico

facturing space in three different plants.

Unexpected hazmat clean-up costs and fines can be staggering—they can shut you down and put you permanently out of business.

Our number one objective is to provide you with a cost-effective way to reduce your hazardous materials risk and liability. Safety Storage is the confident choice—



the hazmat buildings and lockers that are trusted by the Fortune 2000 and the U.S. Government. Whether your need is simply for storage or for a dedicated hazmat building engineered and built to safely isolate and contain a potentially volatile process, Safety Storage is the safe buy. Your best buy. Call us today for complete details.



Every Safety Storage building is built with quality materials and components, and inspected at every step in the production process. Selected models are Factory Mutual System (FM) approved or pending, Underwriters Laboratories (UL) classified, and state certified.



SAFETY STORAGE™

...professional hazmat solutions!

1-800-344-6539

SAFETY STORAGE, INC.

2301 Bert Drive

Hollister, CA 95023

Phone: 408-637-5955

Fax: 408-637-7405

Circle 26 on card.

Remediation Tool

steerable motor to drive the drill head. The system can be used in wells over 6 inches in diameter, and the well can start anywhere from vertical to about 15 degrees from horizontal. The radius of the curvature of the well is approximately 300 feet. The system uses a downhole accelerometer and magnetometer package, which transmits information about the direction of the drilling motor and well to the monitoring rig at the surface.

The Cherrington system got off to a rocky start on one of its early field trials. Cherrington invested a substantial sum in

the development of the system, but when it drilled test wells at the Savannah River Site, the alignment and depths of the drilled wells were considerably off target. This was an unfortunate highly publicized trial outing for Cherrington. As of this writing, Eastman-Cherrington is reorganizing its drilling operations and is not offering drilling services. This may change in the near future.

Perhaps one of the best known pipeline construction companies in the United States is Michaels Construction in Brownsville, Wis. It has been installing pipelines under

riders for a number of years. Michaels uses several different types of equipment, depending on the application.

Before Installation

Several factors need to be considered before a horizontal well is installed.

Type of soils. The installation of a horizontal well will not change the fundamental nature of the soil. Soils that have demonstrated poor conductivity with vertical wells may show only slight improvement with a horizontal well—and that increase may be mainly from the additional length of the well. Jet-hammer systems may have trouble drilling the well when the soils are highly granular and contain cobbles and rocks or gravel larger than 0.5 inch in diameter.

It is more cost-effective and easier to drill a river crossing-type well, where the drill head resurfaces, than it is to drill a blind hole. When the head exits, the hole can be back-reamed by attaching a special tool that enlarges the hole as the drill string is pulled back through the hole. If the hole is to be blind, washover techniques are often used, and a slightly larger hole than required for the finished well is drilled. Perhaps the clearest explanation of the difference between the back reaming and the washover techniques is shown in **Figures 3 and 4** (adapted from a Michaels Construction brochure on horizontal wells).

If the well requires a sand pack, the well will be more difficult and expensive to install. For sand-packing horizontal wells, a special tremmie pipe must be placed down the well and sand pumped into the formation around the final casing. This not only requires special equipment, but also tends to be difficult to install in granular soils because of the tendency of the top of the drill hole to collapse. To overcome this difficulty, drillers sometimes use a prepacked screen, in which the sand is already packed around the well screen.

Physical characteristics of the piping. Some plastic materials used in piping have a low modulus of elasticity and will deform when pulled or pushed into a well. Slotted pipes or screened intervals require special consideration, as the stresses on the pipe can change the size of the pipe, and the slotting can materially weaken it. Transverse slotting can open or close as the pipe is bent, and longitudinal slotting of the pipe will tend to destroy its structural integrity (hoop strength).

Alignment of the well. While some of the systems that use the radio transmitter

IF YOU MUST KNOW WATER QUALITY... YOU MUST KNOW HYDROLAB.

temperature
dissolved oxygen
sp. conductance
conductivity
pH
turbidity
salinity
resistivity
depth/level
TDS
redox
ammonium - NEW!



Are you the expert on your lake, river, bay, or estuary?

Hydrolab will help you know more about your body of water than anyone else in the world. We can do this because we know more than anyone else about the water quality monitoring instruments required for this job.

No matter what the application - freshwater, seawater, groundwater, wastewater, tanks, or aquaria, there is a Hydrolab Multiprobe (all-in-one sensor package) to get you the data you need, with minimum effort and maximum reliability.

CALL 800-949-3766.



Hydrolab Corporation • P.O. Box 50116 • Austin, TX 78763
Telephone 800-949-3766 or 512-255-8841 • FAX 512-255-3106

Helping preserve our world's water resources

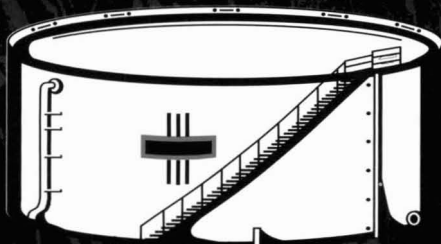

IF IT LEAKS WE FIND IT GUARANTEED

Aboveground storage tank leak detection,
without taking your tank out of service. Tracer Tight® works
or you don't pay. Tracer Research is the only company
that provides a quality assurance verification for every test.

Tracer Research Corporation



3755 N. Business Center Drive
Tucson, AZ 85705-2944
(520) 888-9400
Fax (520) 293-1306

(800) 394-9929

Call for a worldwide location
nearest you.

SUPERIOR QUALITY DETECTION TECHNOLOGIES

Circle 28 on card.

Remediation Tool

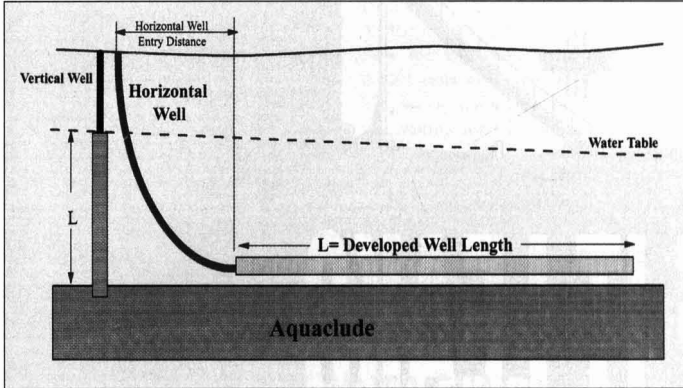

Figure 1. Comparison of Horizontal and Vertical Well Lengths

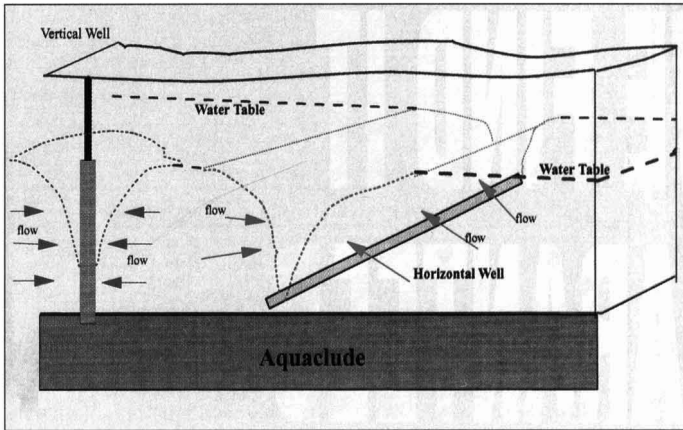

Figure 2. Comparison of Horizontal and Vertical Well Flow Patterns in an Aquifer
Note: Greater length of horizontal well allows greater efficiency for a given aquifer.

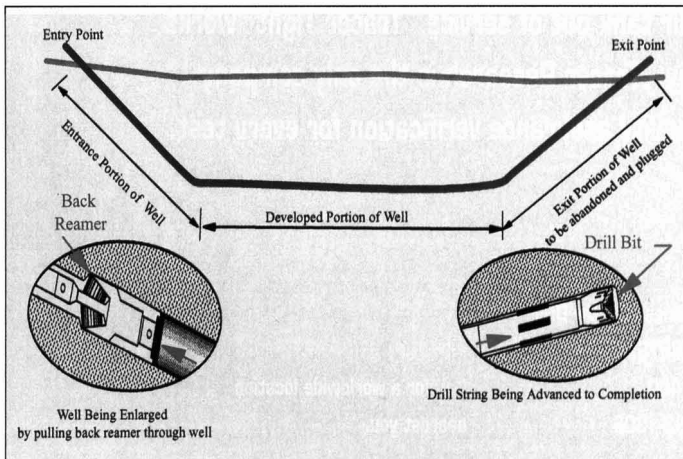

Figure 3. Installation Development Methods for Horizontal Wells with Exit Holes

behind the drill head are good for both alignment and depth in shallow wells, deeper wells are often harder to control. The designer must realize that the horizontal well, especially where there is limited access to the formation, is like a snake in a tunnel—the horizontal borehole may be more saw-tooth-shaped than straight. It is also quite difficult to gain precise control of depth and direction while advancing the well. Precise control of depth and angle is not a certainty.

As an example, in oil-well drilling applications, a horizontal well system was used to intercept a blowout well (8 inches in diameter). A system with a downhole mud motor was used for the drilling but the measurement/accelerometer package was located about 60 feet behind the drill head, which enabled precise control of the direction and depth of the horizontal well.

Cost. This is one of the largest considerations. Horizontal wells are more expensive to install than vertical wells. Most rely on the use of a downhole motor, powered by the drilling mud. According to Sada K. Joshi, horizontal wells are between 1.4 and three times more expensive than vertical wells, depending on the type of drilling system used and the requirements for specific placement of the well (*Horizontal Well Technology*, PennWell Publishing Co., 1991). Several years ago, a 6-inch horizontal well cost more than \$300 per foot of installation. Recently, that figure has dropped to a level more in line with the cost of vertical wells.

Hydraulics. With notable exceptions, many geologists are not trained in the fine points of hydraulics and consequently do not understand the need for careful hydraulic design of the horizontal well system. With respect to the fluid being collected or disbursed, the hydraulics of the system are important.

The quickest way to ensure failure of a horizontal well system is to ignore the hydraulics of the system and to install a longer-than-needed well screen. In many instances, it is better to custom-slot the pipe to ensure adequate distribution of the fluids collected or pumped through the well.

The size of the slot in the pipe and the number of slots per foot of pipe may also affect the strength of the pipe, as most pipe is pushed into the well and under compression. Transverse slots in the pipe can be forced closed by the bending pressures on

Meteorological Instruments

- Wind Speed
- Wind Direction
- Air Temperature
- Relative Humidity
- Precipitation
- Barometric Pressure
- Solar Radiation
- Data Loggers
- Recorders
- Towers & Elevators
- Lightning Protection
- Software
- Installation & Calibration
- Field Service
- Technical Assistance
- Service & Repair
- Instrument Shelters

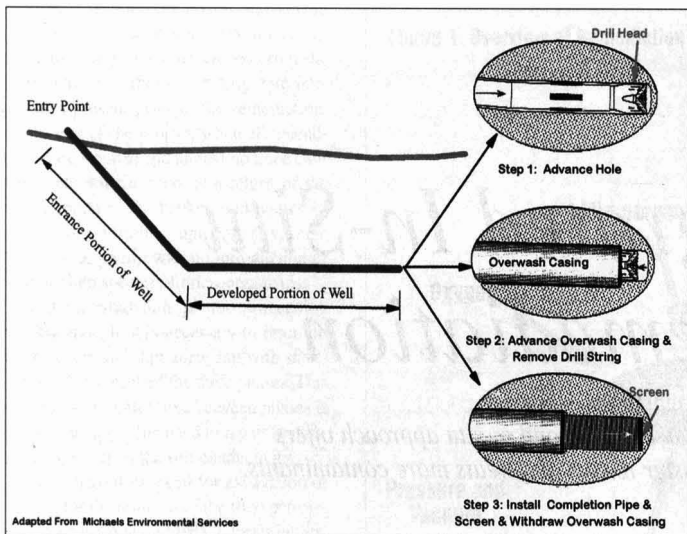

Figure 4. Installation Development Methods for Horizontal Wells without Exit Holes

the well and by the compression necessary to force the pipe into the well.

Temperature and pressure. When the horizontal well is being used for air sparging—injecting air into the underground formation—or vacuum extraction, the temperature and pressure is important, as the expansion of the air flowing through the slots in the pipe may drop the temperature to below freezing.

In one instance, the 140-degree Fahrenheit air exiting the compressor was cooled to 40 degrees F by the time it passed through the pipe wall. Freezing temperatures in the formation may adversely affect the distribution or collection of air, which could defeat the design of the remediation system.

Drilling mud. If the well is to be developed, the mud must be removed. Most drilling muds contain bentonite clays, but special types of muds containing guar gum and polymers can be used at a slightly increased cost. These drilling fluids are biodegradable, and natural bacteria will destroy them after 24 to 72 hours. However, wells developed with these fluids have shown some increase in biological growth, which has plugged the well screen and made additional cleaning and well development necessary.

If the formation is contaminated, the drilling muds used to power, cool and clean the drill bit, as well as the development waters, may be hazardous wastes in need of disposal. The well designer must

balance the need for good permeability of the well, higher well development costs and the cost of hazardous waste disposal of muds and development water.

Pilot Testing

If the horizontal well is to be used successfully, a pilot test is needed to finalize the design parameters before construction and installation. A significant number of unknowns in any geologic system make pilot testing necessary.

When successful pilot testing, good design practice and good installation by an experienced driller come together, the horizontal well system can be a superior remediation tool.

David L. Russell is president of Global Environmental Operations Inc. in Lilburn, Ga.

Coming In February's Environmental Protection

Transforming a landfill from an ugly duckling to an attractive swan.

Don't let biotechnology bug you—we uncover the latest in remediation.

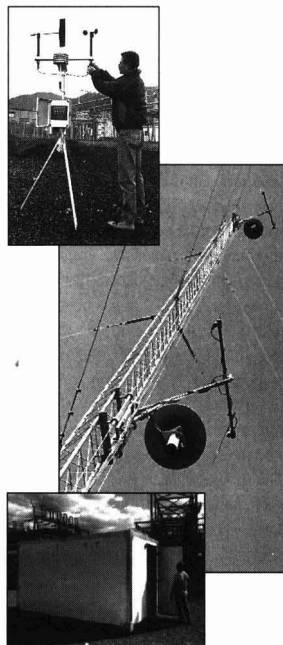

Met One Instruments

1600 Washington Blvd., Grants Pass, OR 97526
Phone (503) 471-7111, Fax (503) 471-7116

Integrated In-Situ Remediation

•An integrated ex-situ and in-situ approach offers better and faster results and treats more contaminants.

By Vincent Fustos and Paul Lieberman

There have been numerous remediation approaches used for removal of specific contaminants under varying soil conditions. When long remediation times are available, the bioremediation system has proven to be economical. On the other hand, when remediation times are short, ex-situ and in-situ chemical approaches have proven to be effective but more expensive. In the integrated approach presented here, there is a sequence of processes that has been used successfully as an individual remediation process in their own right. When combined in a synergistic mode, this approach has achieved short-term, economic remediation. Furthermore, the range of contaminants that can be treated is extended.

The process uses ozone, compressed oxygen, water vapor, heat, bioaugmentation and vapor (or liquid) extraction to remediate not only the lower molecular-weight hydrocarbons but also the recalcitrant higher molecular-weight hydrocarbons, insecticides and complex solvent structures. Furthermore, toxic heavy metals have been complexed so that they form less toxic and insoluble compounds in the soil and can remain safely in place. In cold climates where bioremediation is considered too slow, the >120-degree Fahrenheit humidified air forced into the cold soil will eventually produce 80-degree F extracted vapors. The average temperature in the air voids between the soil particles are at temperatures ideal

for accelerated contaminant degradation reaction rates.

General Process, Three Phases

Bioremediation by itself would take at least two years, considering the large size of typical contaminant modules and soil matrix types. Thus, a modification of bioremediation has been used. This modification is in three separate time phases.

In the first phase, ozone is stabilized and injected into the soil to aid in the oxidation of large complex hydrocarbon molecules, metals and chemically dechlorinated halocarbons. Also, local microorganisms are destroyed so that there will be none available to interfere later with the introduced bioaugmentation. This phase may take as long as 30 days.

The second phase involves bioaugmentation of the in-situ soil. The strain of bacteria, upon entering the soil, will produce a natural exotoxin that will eliminate competing microorganisms and initiate the degradation of the contaminants. Note that the recalcitrant hydrocarbon molecules and chlorinated molecules have been oxidized or reduced so that the biodegradation of the simpler becomes more effective. Also, any heavy metals have been oxidized. During this phase, the soil is inoculated by the injection and introduction of a froth containing nutrients, pH amendments, moisture, increased oxygen content and indigenous microorganisms. This phase will take about 10 days.

In the third phase, there is a steady state

of processes occurring. The injection system distributes and maintains a supply of bacteria throughout the contaminated plume by a combination of pressurized injection and vacuum extraction. It continually introduces heated, moisture-enriched vapor to promote and maintain rapid mineralization (44 times that of normal degradation) of the hydrocarbon contaminants by a thriving *Pseudomonas spp.* population. No nutrients are added in this phase since the contaminants must supply the required energy for the microorganisms. This overall process has proven successful at sites with complex hydrocarbon molecules as well as chlorinated molecules. It also works over a short period of six to 12 months on average.

The "closed loop" remediation approach is reliable and effective in achieving the required reduction in contaminant concentration levels with a margin of safety, speed and economic benefit. The approach of ozonation, biodegradation and low-level heating, along with the controlled distribution of heated, moist, oxygen-enriched and nutrient-amended vapor is currently being patented (see **Figure 1**). The natural bacterial acclimation technique using accelerated generation growth with several trillion generations of species of hydrocarbon-degrading *Pseudomonas spp.* has resulted in a naturally acclimated superior strain registered with the American Type Culture Collection Patent Depository. Furthermore, there is no residual material that needs to be further processed after completion of the

project. The microorganisms introduced into the contaminated zone(s) during the remediation project are developed from the natural hydrocarbon-degrading microorganisms present prior to the remediation. At the end of the project, when all amendments are stopped and almost no trace contaminants remain, there is a return of the natural biota to the background counts of the colony-forming units per volume (CFU/ml or gram), with no introduction of new or alien species of microorganisms.

If the degradation is not proceeding quickly enough, it is necessary to return to the first step and start anew, but with shorter times for each of the three phases. This iteration and shorter time between phases is called "pulsing." The need to resort to pulsing depends upon the soil conductivity.

Since there is no need for excavation of the soil for the removal of the total petroleum hydrocarbons (TPH) contaminants, there is a significant cost savings. Also, the liability is removed compared to other remediation processes such as stabilization and solidification, or chemical fixation, where there is still the possibility of contaminants being leached out again under a

Figure 1. Overview of Remediation Process

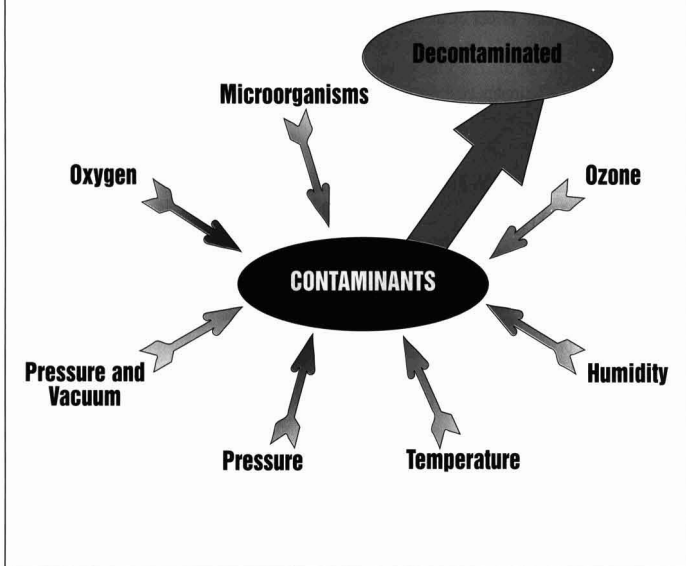

Comply With Model Building Codes. Insist on Haz-Stor.[®]



GSA: GS-28F-0040B



The storage of hazardous materials demands security, segregation and containment. UL's classification mark and data plate are proof positive you'll meet these demands. The *Haz-Stor*[®] premier family of buildings is designed and built to comply with Model Building Codes for Group H - Hazardous Occupancies. Every single unit is examined by UL's Independent Inspectors prior to shipment.



HAZSTOR[®]
HAZARDOUS MATERIALS STORAGE

Haz-Stor[®] Division of Justrite Manufacturing Company LLC
Subsidiary of Federal Signal Corporation

Phone 847-294-1000
Toll Free 800-798-9250
Fax 847-298-9716

©1996 Justrite Manufacturing Co.

Instant Holding Tanks



Petro-Flex[®]

Chem-Flex[™]

- Ideal for waste holding and emergency spill clean-up
- 100 to 100,000 gallon capacities
- Fully collapsible & portable
- Used by U.S. Army, Navy, Marines etc.

THE ESSENTIAL HAZMAT TOOL
IN STOCK FOR FAST EMERGENCY SERVICE

ATL[®] 800-526-5330

AERO TEC LABORATORIES, INC.
Spear Road Industrial Park
Ramsey, NJ 07446-1251 USA
Phone: 201-825-1400

Integrated In-Situ

change in the local chemical environment.

By the use of a series of strong vacuum-driven extraction holes around the periphery of the contaminated plume, engineered specifically for the site's soil conductivity, there is a containment effect created. This containment effect behaves like an "underground drape" without the need for physical barriers. This eliminates cost, time and disturbance to the site, which would be required to emplace a buried vertical, imper-

meable barrier around the plume.

Specific Process

The overall remediation process for the TPH contaminants is achieved in a time sequence of three separate and consecutive phases.

The first phase requires ozonated, heated vapor to be injected into the vadose or groundwater (or both), and also into the deeper saturated zone of the soil. This

ozone-enriched vapor performs important functions essential to the continued breakdown of heavy molecular hydrocarbons, oxygen supply to the bacteria from the ozone-to-oxygen shift, and oxidation of any unwanted metal components found in the soil and/or groundwater. The ozone also assists in the cleavage of chlorine atoms from the halogen compounds, which are recalcitrant to natural degradation.

The ozonated vapor chemically breaks down the larger hydrocarbon molecules into smaller hydrocarbon molecules of the TPH contaminants. The smaller hydrocarbon molecules require shorter biodegradation durations. Ozone has been used as a pretreatment method to oxidize refractory organics since 1983, making them more amenable to biological breakdown.

In the second phase, the indigenous hydrocarbon degrading bacteria (primarily *Pseudomonas spp.*) have been isolated, grown out in the aquaculture, and naturally acclimated with our special strain(s) at a regeneration rate of 13 generations every 24 hours. This process is important for the insured biomass subsurface. The DNA of indigenous bacteria has combined with superior bacteria, and the bacteria then produce natural exotoxins to dominate the site. They also manufacture a natural emulsifant/surfactant when in the starved state to break down the adsorbed phase of TPHs, and they now are able to begin to biodegrade 44 times the normal rate.

The microorganisms, nutrients, oxygen, moisture, heat and other amendments are injected under pressure into the ground at approximately 120 degrees F as a froth. It will take no more than five to 10 days to distribute the blend inside the soil pore spaces within the contaminated plume in the vadose zone, and to raise at least the air entrapped in the soil to a temperature in the entire matrix to about 78 degrees F to 84 degrees F. With the inflow of moisture, heat, oxygen and pH amendments, the injected microorganisms will multiply and degrade the TPH rapidly, especially in the controlled environment subsurface. Other than a few symbiotic yeasts, the exotoxin destroys the local microbe population. Thus, the inoculated strain has no competition or deterrent to its survival and growth. This allows for site dominance of the hydrocarbon-degrading bacteria.

In the third phase, the process is maintained except that the warm, moisturized, oxygen-enriched and amended vapor is circulated under pressure into the vadose and/or groundwater to continue and main-

Mobile Treatment Services

- Water Purification
- Wastewater Treatment
- Chemical Separations
- Trained Technicians
- State of the Art Lab
- R&D Staff

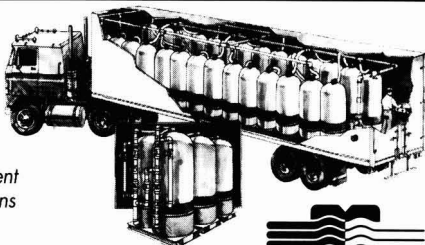

800-238-3028

2070 Airways Blvd., Memphis, TN 38114
Fax: (901) 743-2361; (901) 744-1142

MOBILE PROCESS TECHNOLOGY
Since 1969

Circle 33 on card.

BIOREMEDIATION

How to get more ACTION from your "bugs".

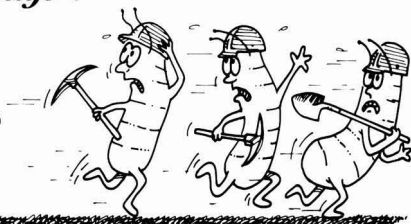

Chase them with a "BEAR".

The powerful Brown Bear horizontal auger tractor NOW gives you even better:

- Mixing of inoculants or nutrients
- Liquid application and incorporation in a single pass
- Greater capacity with angled auger head
- Particle size reduction with paddle auger design
- Self Propelled and Attachment models available



BROWN BEAR

BROWN BEAR CORP., CORNING, IA 50841
PHONE: 515-322-4220, FAX: 515-322-3527

Circle 32 on card.

Plan to Attend the Premier Environmental Event in North America...

“Technologies for a Sustainable Environment”

*The Air & Waste Management Association's
89th Annual Meeting & Exhibition*

June 23-28, 1996

Nashville, Tennessee, USA

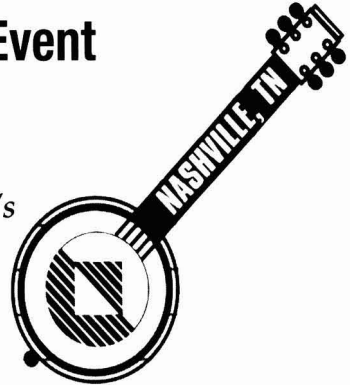

As an environmental professional, you can't afford to miss...

- ... an opportunity to network with over 7,000 environmental professionals from all over the world.
- ... a quality technical program with 185 sessions and over 840 papers presented.
- ... a comprehensive educational program, immediately preceding and during the Annual Meeting.
- ... an exhibition hall filled with nearly 500 companies displaying the latest technologies and services in the industry.

To reserve your complimentary copy of A&WMA's Annual Meeting & Exhibition Preview, Exhibitor Prospectus or Membership Information, please complete the coupon below and mail it to us. Or, fax the coupon to the Association at (412) 232-3450

Please send me further information on A&WMA's 89th Annual Meeting & Exhibition!

I'm interested in attending. Please send my complimentary copy of the Preview including registration information.

I'm interested in exhibiting. Please send me a copy of the Exhibitor Prospectus immediately.

I'm interested in becoming a member of A&WMA. Please send membership information immediately.

Name _____

Title _____

Affiliation _____

Street/P.O. Box _____

City/State/Province _____ Zip/Postal Code _____

Country _____ Telephone Number _____ Fax Number _____

*Air & Waste Management Association, One Gateway Center, Third Floor, Pittsburgh, PA 15222
(412) 232-3444 Telephone, (412) 232-3450 Fax*

AM 9

**Benzene Degradation Vadose Zone History
AMOCO Rainbo #2, Salt Lake City, Utah**

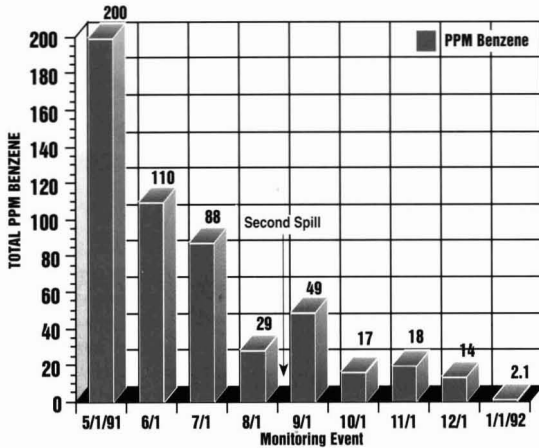

Progression of benzene degradation in Vadose Zone Due to Biogradation

tain the biodegradation of the contaminants in the plume area. The vapors extracted from the vapor-return holes are treated aboard the trailer at the ground surface (mobile biotreatment system) which contains absorption chambers and biopolishing chambers for contaminated soil gas vapor removal and degradation. The system is closed-looped.

The cleaned return vapor, now rich in the items from the aforementioned treatment, is recirculated back through the injection holes. This cycling continues until the end point, where the process reaches the stage where the final products are carbon dioxide, water and a few harmless enzymes generated from the complete mineralization of the TPH compounds during degradation.

When the TPH degradation has been completed, the microorganisms have no further carbon source. In addition, the nutrient and amendment protocol have been removed. The die-off phase of the bacterial cell life cycle begins. It is important to note that the injected amendments are reduced

Control Emissions.

ANNUBAR®

MASS FLOW MONITORING SYSTEMS

The new Annubar® Mass Flow Monitoring System, featuring the DSF-46 Annubar and Dart™ II Flow Computer, is the low cost, reliable way to measure mass flow accurately. Annubar is the solution. Dieterich Standard, P.O. Box 9000, Boulder, CO 80301 (303) 530-9600 • FAX: (303) 530-7064

Dieterich Standard
A DOVER Industries Company

Keeping our little corner of the world a lot cleaner.

**Advanced Hazardous Waste Treatment
Environmental Engineering Services**

**vonRoll
WTI**

East Liverpool, Ohio • 800.545.7655

during this phase so that the bacteria are starved and forced to produce emulsifants and surfactants to break into "sheened" layers on soil particles as well as only seek TPH carbon-source energy. This strain of *Pseudomonas* also has the ability to prevent fatty acid build-up in the soil pore space by converting the amino acids responsible for the fatty acid into a secondary protein source and consuming this for energy.

These three treatment phases result in a rapid cleanup of the site. Where cold temperatures prevail over the shallow soil depths during the winter, the available in-situ biodegradation remediation process would be slow to none. However, in this process, the heated, moist vapor increases and maintains temperatures for the optimal levels for the microorganisms through the entire project. **EP**

Vincent Fustus is vice president of Bio-Remedial Technologies Inc., in Hermitage, Pa. Paul Lieberman is chief scientist, National Technical Systems, in Fullerton, Calif.

Benzene Degradation Groundwater Monitoring Well B-4 AMOCO Rainbo #2, Salt Lake City, Utah

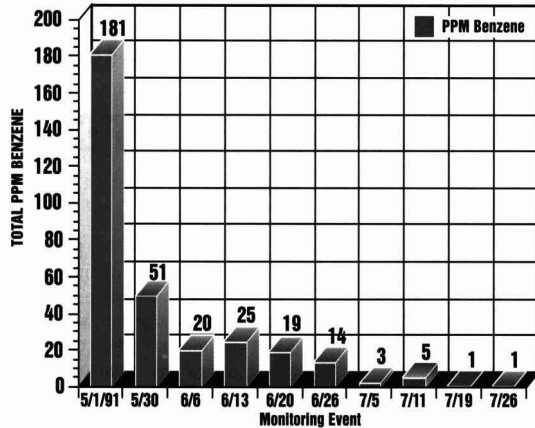

Progression of Benzene Degradation in Groundwater Zone Due to Biogradation

We know how
[EARTH SHAKING]
a spill can be.

When the spill of the century hit the coast of Alaska, New Pig was there. We went because we could help. For over 10 years now, New Pig Corporation has been your partner in solving leak and spill problems. Some spills are unavoidable. Together we can make a difference. When spills are handled properly, the earth offers its undying thanks.

 **New Pig**

1-800-HOT-HOGS®
(468-4647)

The LOGICAL Choice for Compliance



Environmental, Health & Safety Software

- Hazardous materials management
- Materials & waste tracking
- Compliance reporting

1-800/COMPLY 1

E-Mail: logical@comply1.com
Fax: 309/689-2911

Regulatory Chemical Databases
MSDS Loading

10th Anniversary

LOGICAL
TECHNOLOGY, INC.

Setting Up and Conducting Training Reinforcement Systems

YOU ARE AN ENVIRONMENTAL HEALTH AND SAFETY practitioner working within an operations environment. Ask yourself the following question: "When a new piece of equipment is received in the area, is it worth

the time and effort to be certain that employees know how to use it efficiently and effectively?"

Managers frequently express a certain amount of frustration with the time spent on annual training to maintain regulatory compliance. It isn't that they object to training their people or providing a safe and environmentally friendly workplace, it is because they are frustrated by what frequently seems to be a lack of results achieved by such activities. They seem concerned that the training achieves little or no results. The problem is

that managers and supervisors do not always understand or appreciate their own role in the annual training process. This same situation is equally true when new regulations are put into place.

Having employees attend training on a new regulation is like receiving a new piece of equipment in the workplace. To receive full value for the time and money expended, it is critical that the proper planning and preparation be conducted. The ever-present meetings will be conducted, plans will be drawn up identifying who must attend training and when, and the trainer will be given marching orders to go forth and educate the workforce. If that is all that transpires, the training may achieve the desired result of providing workers the instruction that is mandated by law. However, it may widely miss the mark of the regulation's intent, which is for workers to be trained and be able to apply the newly acquired knowledge. At this point, reinforcement by the trainer, supervisors and management comes into play.

Having workers attend annual refresher training is like providing preventative maintenance on a pump or an engine. There may be absolutely nothing wrong with the equipment at present, but the maintenance is conducted to be certain.

Reinforcement is critical to the adult learning process and ensures continued compliance with the regulations. It is one of the most important features of an effective training strategy. Unfortunately, reinforcement is also one of the most commonly overlooked and underappreciated features of training. The failure to establish and follow through with training reinforcement can be viewed as one of the major sources for EHS training not meeting industry needs today. Why does this happen? Generally, it occurs for one of two reasons: either management lacks the knowledge to reinforce training effectively or there is a lack of consistency in the reinforcement effort.

A Systems Approach

At this point professional trainers, such as those certified through the National Environmental Training Association (NETA), can provide assistance in overcoming this potential difficulty. A professional trainer can take a systems approach to training and training program design, working with trainees and management on needs analysis and setting objectives that are in line with management's goals. When training reflects the corporate goals, there is continual reinforcement.

Companies spend enormous amounts of time and money on worker EHS training. Employees are sent to training sessions, and then several weeks or months later management wonders why employees appear to be doing nothing different or why compliance issues continue to plague a facility. The source of failure in these instances may be managers' lack of knowledge pertaining to their role in the training. This is often demonstrated in part by the belief that if employees attend training, they have received all the information necessary and there is nothing else for the managers to do. This view seems also to include the belief that the participants should automatically know how to apply the knowledge they have learned.

This just isn't true. Knowledge and application are two different issues. For learning to occur, trainees

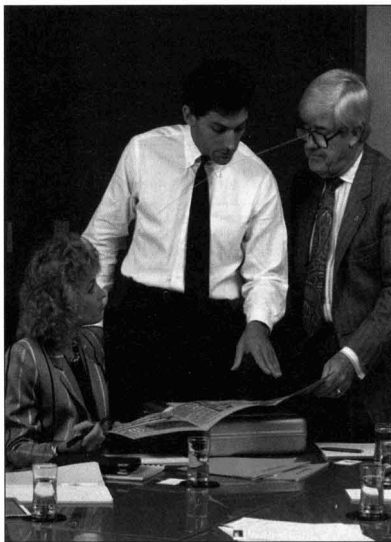

NOW INTRINSICALLY SAFE

*Miniature
Photoionization Monitor!*

2020 I/S

*The PID for superior detection of
VOCs in Environmental and
Industrial Hygiene
Applications*



- Small size and weight ... less than 2 lbs!
- Intrinsically Safe Class I, Division 1 Groups A, B, C & D
- Easy to read, simple to use
- Powerful integrated datalogging software
- Sub-PPM sensitivity
- Field rugged

PE PHOTOVAC

Photovac Monitoring Instruments
25-B Jefryn Boulevard West, Deer Park, NY 11729
Tel: (516) 254-4199 • Fax: (516) 254-4284

must have time to see a need based on experience. Next, they gather and reflect on new information, synthesize the new material and apply the information. Without an opportunity to go through all four phases, there isn't total learning. Sometimes training only exposes trainees to a portion of the adult learning cycle, usually the identification of need and the presentation of new material, but doesn't allow time to synthesize and apply information.

Workers sent off to attend training frequently have little or no idea what they are supposed to learn. Why? Because no one tells them. Based on some of our experiences, they are only told when and where the session is to be held. When they do learn something new, they may have no idea how to implement it in their work area. It often seems employees are supposed to read the boss's mind and know what is expected. Even if the program is simply a cursory annual review of a mandated class, the employee still requires some information.

The failure to provide any information is in itself informative—in this case, it shows management isn't overly concerned with the issue. The purpose of the training should be discussed with workers before and after the session.

Keys to Success

Knowledge and consistency are the keys to successful training reinforcement. Consistent support of a training program should come from several areas: those requesting training, the presenters and upper management. Upper management's support is most often shown by not only meeting the letter of the regulations, but the spirit of the regulations as well. It also involves providing whatever resources and materials are necessary.

Consistency is most actively supported through verbal and visual reinforcement. All company communication must reinforce these messages. Commitment must be conveyed throughout the company in such ways as literature, memos, performance reviews and operating standards. One of the most valuable means a manager or executive has for training reinforcement has been demonstrated throughout numerous companies with the EHS training of employees.

Time is made available to attend both the opening and closing of the new-hire training to inform the participants of the value of the training. Afterward, this message is reemphasized. There is never a reason for nonattendance by a manager or executive—not if they really mean what they say.

Another form of consistency involves enforcement. Enforcement consistency means that procedures and policies in which workers are trained apply to everyone, regardless of position or circumstance. Favoritism or overlooking conduct because it was a member of management is not the way to reinforce training or achieve success in EHS compliance.

Consistent reinforcement relies upon open and honest feedback among all players. Some feedback can be gained from evaluation instruments; others from observation of changes in individual or group behavior and results. The most productive feedback comes from dialogue among trainers, attendees, line supervisors and managers. The goal of training is not just to increase skills in one aspect of the job but to enhance appreciation of learning as well.

Two-Way Communication

When a program is first announced and participants selected, the workers' supervisors need to sit down with the employees and review what is expected following their return from training. If there are new skills involved, how will they be measured? How long do

Training

the employees have to "get up to speed?" If additional knowledge or concepts are to be covered, how does management expect them to be applied? If there have been some deficiencies in the department's EHS performance, this is also an opportunity for managers to identify what needs to be changed and how this training will assist in the effort.

There may be other aspects of the training that the managers feel more strongly about and want the workers to emphasize. In any case, the more information the workers have before attending, the better they will be able to meet the managers' needs in terms of post-training performance.

As soon as the workers return to work from training, the managers need to immediately take the time to begin the reinforcement process. This can be accomplished by asking about the session and if they found it interesting. What exactly did they learn and what questions do they still have? More importantly, "How do you see this being ap-

plied in our area? What obstacles do you foresee? How can we overcome them?"

This should be discussed in detail with each person. Take into account the workers' position; if it appears they are lacking some aspect of understanding, make the necessary input correction. Workers also need to

- My boss IS interested in what went on,
- My boss DOES expect me to apply what I learned and

- My boss IS going to be following-up on how I use the information.

Once this discussion has been held, allow the workers a few days to incorporate the information into the normal work routine. Then go out and observe it being put into practice. Make certain the workers know the manager is present. If anything is amiss with the performance, take the time then to discuss it fully. Management must help workers find the means of fully integrating the material into the work. **ED**

Interaction between management and employees is essential in effective training reinforcement systems.

know how management will follow up on the training and what specific behaviors are to be changed.

Getting the Message Across

If handled in this manner, the meeting will send a series of distinct messages to the employee, including:

Carol Kefford Eshelman is a certified environmental trainer and independent consultant in Baltimore, Md. Craig A. Woodacre is a certified environmental trainer currently employed by Bristol Myers Squibb at its Syracuse, N.Y., facility. Both are active members of the National Environmental Training Association.



PALLFLEX®

THE SOURCE FOR EXCLUSIVE

- Teflon* coated Glass Fiber Filters
- Pure Quartz Fiber Filters
- Pure Teflon* Disc Filters
- Pure Borosilicate Glass Fiber Filters

FOR USE IN HI-VOL SAMPLERS

- PM₁₀ Samplers
- Dichotomous Samplers
- Diesel Exhaust Analysis
- Custom Apparatus

Available 8mm to 40 inches

PALLFLEX CO.
125 KENNEDY DRIVE
PUTNAM, CT 06260
(OF PALL CORPORATION)
PHONE (203) 928-7761
FAX (203) 928-3584

* Trademark of E.I. duPont de Nemours & Co. (Fiberfilm & Tissuquartz are trademarks of Pallflex.)

FREE

FULL COLOR CATALOG!



We Specialize in Hand-Operated Soil Sampling Equipment for the Pollution Control Industry!

- Backsaver Handles
- Sampling Tubes with Liners
- Bucket Augers
- Complete Kits

Call or Write Today!
Clements Associates Inc
1992 Hunter Ave. Newton, IA 50208
PH:1-800-247-6630 or 515-792-8285



HOT SPOTS a new and innovative way of getting the advertising results you want!

Call your advertising representative for more information, and reserve your **HOT SPOT** today!

In Texas call
(817) 662-1134
or call (800) 727-7573
outside of Texas.

HERE'S A PLUG FOR BADGER RECORDALL® DISC METERS.

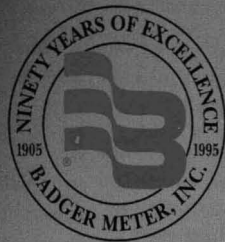
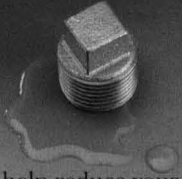
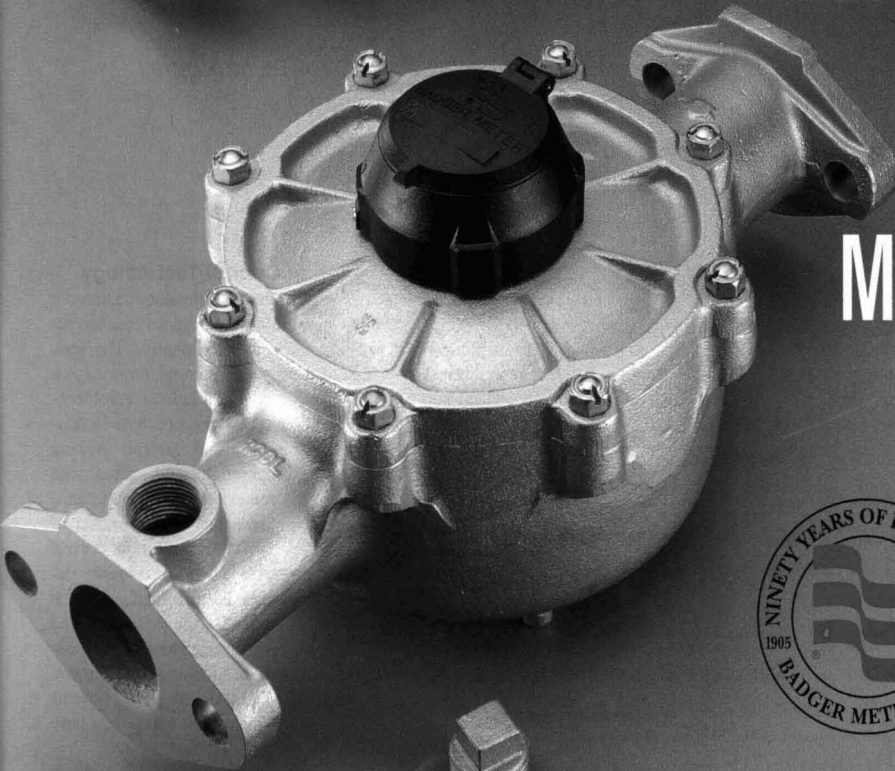

We have the solution to help reduce your operational costs. Optional 1-inch test plugs on our 1½" and 2" meters. Put an end to removing and reinstalling meters during field accuracy and pressure testing. Put us to the test. For all the facts, call our toll-free number or see your Badger Meter representative today.

Badger Meter, Inc.
THE LEADER IN METER READING TECHNOLOGIES.

4545 W. Brown Deer Road
P.O. Box 23099
Milwaukee, WI 53223-0099
414-355-0400
Toll-free 1-800-633-0986

Circle 42 on card.

Member AWWA, AMRA and NRWA



An independently owned American company.

BADGER METER: LEADERSHIP INTO THE NEXT CENTURY
BADGER METER: LEADERSHIP INTO THE NEXT CENTURY
BADGER METER: LEADERSHIP INTO THE NEXT CENTURY

Air Pollution Control in an Age of Prevention

A balance of both pollution prevention and pollution control technologies is necessary for clean air and a healthy economy.

By Jeffrey C. Smith

Pollution prevention is an outstanding idea, one which envisions redesigned methods of industrial production that avoid generating polluting waste products, and consequently creating the need for pollution control technology. The potential problem with a good idea, however, is that it is prone to being applied too broadly and indiscriminately. Inappropriately applied, a good idea can cause unintended results.

In the case of air pollution control technology, often labeled (mistakenly) as “end-of-the-pipe” technology, the case for pollution prevention is frequently cast as a case against pollution control technology. The errors in this argument are that pollution control technology is always the more expensive compliance option, and that pollution prevention techniques exist to solve all or most of our nation’s air quality problems.

A true market-based clean air policy, however, would not contain these assumptions and would favor neither pollution prevention nor pollution control technology. Rather, the policy would set a goal and appoint the market as the arbiter of final compliance decisions.

Looking ahead, it seems certain that

policy makers will defer more to the marketplace to create cost-effective strategies to achieve the clean air goals supported by a majority of Americans. The Institute of Clean Air Companies, which represents stationary source air pollution control suppliers, has long supported a market- and performance-based approach to clean air

Clean air policy must assure that efforts to prevent pollution in fact eliminate it, and not just reroute it.

policy, as well as policies that promote flexible compliance and pollution prevention.

To achieve clean air goals, pollution control technology will need to be deployed even under the most optimistic scenario for market penetration of pollution prevention techniques. In many cases, often involving the country’s largest air pollution sources, pollution control technology is the only way—technically or economically—to reduce air pollution to a low enough level to attain our clean air goals. A fundamental retooling of power generation and industrial production methods will not happen overnight.

Pollution Control Technology

Air pollution control technology captures or destroys harmful pollutants so they are not emitted into the atmosphere. The term “end-of-the-pipeline” control, however, is a misnomer, since air pollution control technology has in recent years become increasingly integrated into overall system operation and often can remove many pollutants. Since the Clean Air Act of 1970, air pollution control technology costs have declined dramatically in real terms, while reliability and performance have increased—often to nearly 100 percent. And closed-loop systems which reuse byproducts have been commercialized.

Air Quality

By all accounts, air pollution control technology is the reason for substantial reductions in U.S. air pollution emissions and the resultant increase in protection of public health and the environment. In the last 10 years, carbon monoxide emissions have decreased 15 percent; volatile organic compounds, 9 percent; particulate matter, 10 percent; and sulfur dioxide, 6 percent. Of the major (criteria) pollutants, only nitrogen oxides have increased (by 1 percent) over the past 10 years. Reductions in emissions of major pollutants since 1970 have been even greater.

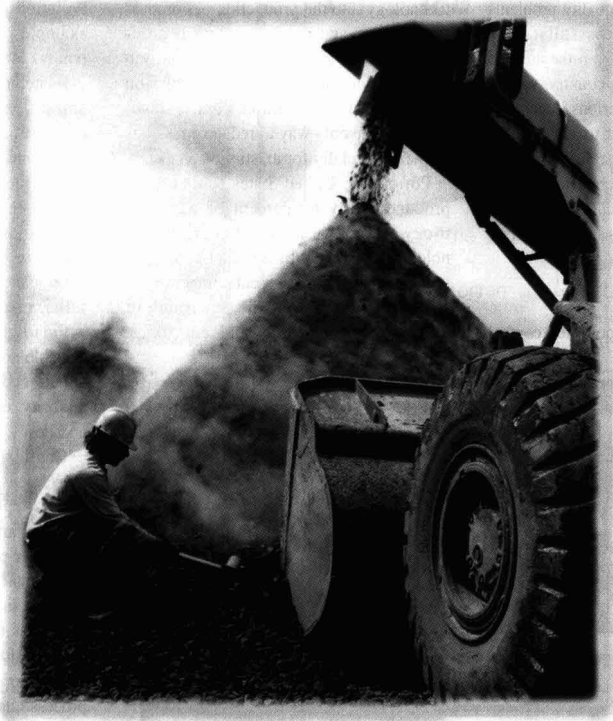

Today, you need environmental insurance to be in an environmental business.

Environmental companies operate in a world filled with risk created by complex business problems and a web of ever-changing regulations. Faced with financial and liability uncertainties, failure to obtain proper environmental insurance protection could ultimately lead to business failure.

Fortunately, ECS Underwriting and Reliance National have an unequaled understanding of the insurance needs of the environmental industry. At the forefront of environmental insurance since 1979, no one else provides a stronger array of environmental insurance products. That means transporters, generators, consultants, contractors, treatment facilities and many others can properly address environmental liability exposures. When you do, you benefit from a level of experience and service, unsurpassed in the insurance industry... and available only through ECS Underwriting.

If your business is environmental, you have an environmental exposure, and your current insurance may not provide the environmental coverage you need. Don't find out the hard way. Call 800-ECS-1414 and talk to the experts at ECS Underwriting today.



Environmental insurance protection for Worldwide industry.

Offering: Automobile Liability & Physical Damage • Consultants Environmental Liability • Contract Surety • Contractors Pollution Liability
Errors & Omissions • Excess Liability • General Liability • Pollution & Remediation Legal Liability • Pollution Clean-up
Pollution Legal Liability • Products Liability

520 Eagleview Boulevard, P.O. Box 636, Exton, PA 19341. Or call 1-800-ECS-1414 (In PA 610-458-0570), FAX 610-458-8667.

Programs are underwritten by Reliance National Indemnity Company, a member of the Reliance Insurance Group.

Copyright 1994

Circle 44 on card.

Despite these gains, air quality problems remain. Many urban areas still fail to ensure the public's health from the adverse effects of smog. And as a country, we are just beginning to address serious issues presented by nontraditional air toxics and fine particulate matter emissions. An expanding population base and an increasing number of pollution sources also contribute to the need for further reductions in air pollution to meet our clean air goals.

Greater Reductions

In addition to integrating pollution control

technology into the production or combustion process and reusing system byproducts, there are many cases—often involving our nation's largest emission sources—where pollution control technology is the only way to reduce emissions further, especially for existing sources.

Power. The United States burns coal to produce nearly 60 percent of our electricity. Available pollution control technologies exist to burn this fuel consistent with health and environmental imperatives, reducing significantly the emissions of both criteria pollutants and air toxics.

Pollution prevention by conservation, for example, will not under any scenario remove the need to burn coal.

Switching to "clean" fuels such as natural gas can account for only a fraction of coal use, and even natural gas produces significant amounts of nitrogen oxides and carbon monoxide when burned. Pollution control technology is needed to destroy these pollutants. It can do so with an efficiency of 98 percent or higher, compared to only about 50 percent at best for upfront sulfur removal processes.

Finally, generating electricity from renewable sources such as solar energy will not be economical or able to shoulder a majority of our power needs for many decades.

Coatings. Many coatings, varnishes and inks release pollutants into the air when used. Replacing these with nonpollutant-releasing materials may be very expensive or may be possible only at the price of poor performance coatings that do not work as well. In such cases, pollution control technology is the most cost-effective way to cut emissions.

In other cases, such as with acid etching, process changes can reduce but not eliminate acid gas emissions; only pollution control technology can protect the environment.

In addition, recent experience with market-based clean air policy shows that pollution control technology complements—and sometimes is a requirement for—the workability of such a policy. For example, emissions trading provides an incentive for overcontrol of selected units to avoid control at others. Overcontrol is often possible only via use of pollution control technology achieving high pollution removal (95 percent to 99 percent or higher). Public health, the environment and regulated industry all benefit when emissions trading allows emissions to be reduced beyond mandated amounts, at a lower cost using pollution control technology.

Clean air policy must also assure that efforts to prevent pollution in fact eliminate it, not just reroute it. For example, a West Coast municipality sought to prevent pollution by ordering its water treatment facility to refuse to accept solvents. This action did minimize the discharge of organics to the local water body but did not prevent contamination of the environment. The solvents had to be disposed somewhere. They ended up being burned without pollution control technology, thus contaminating the environment more than if they had been treated initially.

Multi-Modular:
Air • Solid/Haz Waste • Wastewater

Once you compare *i*-STEPS™, there's no comparison.

i-STEPS™ is the most advanced, easy-to-use solution available for environmental data management.

Use *i*-STEPS to prepare annual emission reports, track emissions for demonstrating daily compliance, and support Title V applications.

- Microsoft® Windows™-based
- Network-ready, multi-user environment
- Full compatibility with EPA's AIRS
- Single entry of data, automatic data validation
- Built-in and user-definable emission formulas
- Unique, multiple views of emissions/process streams
- Sophisticated security controls and comprehensive audit trail
- A full range of standard, ad-hoc reports and graphs
- Customizable screens, optional CAD interface, and more

Plus, you get complete, on-site training as well as comprehensive technical support.

PACIFIC ENVIRONMENTAL SERVICES, INC.

Telephone: 919/941-0333
 Telefax: 919/941-0234
 Internet: i-steps@rtp.pes.com
 Home page: <http://www.pes.com/pes>

*iSTEPS™ is a trademark of Pacific Environmental Services, Inc.™. Microsoft Windows™ is a trademark of Microsoft Corporation.

LEASE & PURCHASE Industrial Weather Monitoring Systems

Services Include:

- Design
- Installation
- Maintenance
- Calibration
- Audits
- Database / Display software

Leading Manufacturers:

- Campbell Scientific
- R. M. Young
- Vaisala
- Climatronics

Dataloggers and Sensors to Monitor:

- Temperature
- Relative humidity
- Wind speed
- Wind direction
- Air pressure
- Precipitation
- Water level

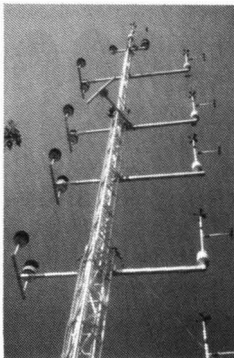

WEATHER FORECASTING AND CONSULTING SERVICES



Weather Network, Inc.

California: Tel 916-893-0308

Fax 916-893-4517

Texas: Tel 713-578-6376

Fax 713-579-1531

Providing meteorological services for over 40 years!

Circle 160 on card.

Windows™
software

Tame the Audit Monster



- automate the audit process
- measure program performance



- action tracking simplified
- standalone or integrate with AUDITProfiles™



Protocol Library

- EPA, OSHA regulations
- Special Programs—VPP, ISO, Management

1-800-EPI-6484

410-964-9900 ♦ 410-964-0008 FAX



ENVIRONMENTAL PROFILES, INC.

© 1995 All rights reserved

Circle 46 on card.

For Specific Ethylene Oxide Monitoring

STERILIZER MAINTENANCE • STERILIZER WORKPLACE AREAS

The PE Photovac SnapShot gives you fast, accurate readings at the press of a button!

- Intrinsically Safe (CI, D1, Groups A,B,C,D)
- Fast, accurate & sensitive... 0.1 ppm ETO!
- Built-in display of Ethylene Oxide Concentration
- Very easy to use
- Automatic compliance reports
- Low cost per sample
- Truly hand-held... less than 10 lbs.



PE PHOTOVAC

Photovac Monitoring Instruments

25-B Jefryn Boulevard West • Deer Park, NY 11729 • Tel: (516) 254-4199 • Fax: (516) 254-4284

**Environmental
PROTECTION**

Compliance Resources

9 out of every 10 questions regarding regulatory compliance are found right in the pages of manuals printed by government agencies. But finding the ones that apply to your specific area can often be expensive and time consuming.

To better serve our subscribers, Stevens Publishing has located these often-obscure and most-always expensive manuals and reprinted them in their entirety at a substantial savings to you.

**RCRA
Inspection
Manual**

RCRA Inspection Manual – Official Edition!

This new RCRA manual for EPA's compliance inspectors gives you the checklists, procedures, priorities, and protocol of an inspection from entrance to exit. This EPA guide includes a summary of the regulations.

#35-7272, Softcover, 392 pp., Nov. 1993, **\$49.95**
Compare at \$125.00

**NPDES
Compliance
Inspection
Manual**

NPDES Compliance/Inspection Manual

Technical specifics in this EPA manual clarify how to comply with the regulations. Instructions for inspectors on procedures and a description of the NPDES program provide an insider's look at compliance.

#35-6733, Softcover, 134 pp., May 1988, **\$39.95**
Compare at \$69.00

**Chemical
Information
Manual**

Chemical Information Manual

Documented and described in this pertinent manual are over 800 chemicals found in the workplace. Indexed by synonyms and CAS numbers, the information includes chemical information, health effects, exposure limits, and more. This reference for OSHA compliance inspectors also describes OSHA's sampling and analysis methods.

#30-2436, Softcover, 671 pp., July 1991, **\$49.95**
Compare at \$61.00

**OSHA
Technical
Manual**

OSHA Technical Manual

Heavily revised and greatly expanded, the latest OSHA manual used by OSHA inspectors covers inspection guidelines for various sampling techniques and procedures, heat stress effects, noise measurements and hearing conservation evaluations, back disorders and injuries, indoor air quality, hospitals, technical equipment, chemical protective clothing, and much more.

#30-6748, Softcover, 324 pp., Apr. 1993, **\$39.95**
Compare at \$79.00

**NPDES
Best
Management
Practices
Manual**

NPDES Best Management Practices Manual

This EPA manual is an indispensable tool for any industry under regulation. Detailing not only what BMPs are, but also how they work, this handbook's utility is enhanced by industry-specific BMP plans. Included are regulatory policies, information on inspections, training, recordkeeping, and important resources (national, regional, state, and more) for determining Best Management Practices.

#35-6732, Softcover, 198 pp., Oct. 1993, **\$39.95**

**Control
Technologies
FOR
Hazardous Air
Pollutants**

Control Technologies for Hazardous Air Pollutants

This manual is used by EPA technical personnel both to answer questions from potential permit applicants and also to evaluate and review permit applications from facilities with potential hazardous air pollutant (HAP) emissions. Discussions cover complete design and cost considerations for thermal and catalytic incineration, flares, boilers/heaters, carbon adsorption, absorption, condensers, fabric filters, electrostatic precipitators, and Venturi scrubbers. Throughout this EPA handbook are calculation sheets, effluent characteristics for emission streams, potential HAPs and emission sources for various industries, comparisons and cost factors of the control technologies, and much more.

#35-4277, Softcover, 260 pp., June 1992, **\$39.95**
Compare at \$73.00

Pollution Control vs. Prevention

In general, a process designed to generate fewer pollutants may consume more energy or more water overall. As with all environmental policy, a holistic approach is important.

Finally, regulated industry must be allowed to select the most cost-effective compliance option, and that is often a technology approach.

Millions of Jobs Generated

Pollution prevention has the potential to boost productivity, thus providing economic benefits to an industry in particular and to the economy in general. The U.S. environmental technology industry (ET) also delivers real economic benefits: millions of U.S. jobs as well as a trade surplus. Several million Americans work at jobs related to pollution abatement and environmental protection. These jobs are dispersed widely throughout the states and occur in many sectors of the economy. Many of these jobs are high-tech, such as engineering and computer-aided design; others involve traditional manufacturing, trans-

port and communication. Only 11 percent of ET industry jobs are in the government sector.

The U.S. ET industry is also generating a trade surplus, with exports of air pollution controls leading the way. Ensuring a domestic ET industry guarantees cheaper, better products for regulated U.S. industry than would dependence on foreign suppliers.

Bridge to Tomorrow

Why does the air pollution control technology industry support a flexible clean air policy that features market-based approaches and pollution prevention? The reason is enlightened self-interest. Much of the technological innovation in the field comes from established air pollution control firms. By preserving the option of technological innovation via market-based performance standards, members of the industry maintain the opportunity to gain a competitive edge on each other.

Equally important is the air pollution control industry's recognition that its

future depends on the health of regulated business and low control costs that the public can support. With market-based approaches to clean air policy, actual monetary benefits are possible for industry, their shareholders and customers.

Pollution control technology is responsible for substantial air quality improvements and positive macroeconomic benefits. The technology itself has become integrated into production processes and has improved greatly in terms of its cost-effectiveness. Most importantly, pollution control technology is necessary to achieve our nation's clean air goals. Without it, we consign ourselves and future generations to unnecessary illness and even premature death.

If we really mean what we say about letting the marketplace decide clean air compliance options, then pollution prevention and pollution technology should be left alone to fight for dominance. **EP**

Jeffrey C. Smith is executive director of the Institute of Clean Air Companies, Inc., Washington, D.C.

NEWS UPDATE

continued from page 10

Engineers Turn to Age-Old Process to Treat Wastewater

A liquid-liquid extraction process used in the pharmaceutical, petroleum, petrochemical and nuclear industries appears well positioned to solve many of the problems facing today's pollution-control engineers. Speaking at the recent American Institute of Chemical Engineers' annual meeting in Miami Beach, Fla., Roger W. Cusack said the use of the liquid-liquid extraction technique hasn't diminished over the years.

What has changed is the nature of the problem to be solved, many of which currently are in the environmental arena.

"Extraction offers the potential to solve some very difficult wastewater problems while, at the same time, offering the potential to recycle materials rather than merely destroying them by biological treatment, oxidation or incineration," said Cusack, vice president of Glitsch Technology Corp.

The technique involves separating the components in a liquid using liquid solvents, such as recovering antibiotics from fermentation broths or separating vitamins. The largest untapped potential for the process is the removal of organic contami-

nants from wastewater, he said.

Because the process is rugged, it can handle the solids, oils, grease and aggressive chemicals, which often show up in streams.

California Tar Balls Showing Up in Alaska Waterway

The Exxon Valdez, the oil tanker that hit a reef off of Alaska and caused the nation's worst oil spill, may not be responsible for the tar balls washing up in Prince William Sound, experts said. Instead, they blame the 1964 Alaskan earthquake and accompanying tsunami, or tidal wave, that destroyed buildings and storage tanks holding marine fuel oil and paving asphalt imported from California.

The structures are along Prince William Sound, which is also where the port city of Valdez, Alaska, sits. The experts believed that the tsunami swept stored petroleum products into the sound, and the remainder continued to leak into the waters the following four years. Before the discovery of oil in 1968 on Alaska's North Slope, the state had to import petroleum resources, including paving asphalt, fuel oil and gasoline from California.

In examining tar ball samples, the experts said 28 were from the Exxon Valdez disaster while 61 were from the Wilmington oil field near Los Angeles, Calif. They based their identification on the relative abundance of an isotope of carbon, C-13. Oil from different geographic regions contains different isotope patterns.

Penn State Joins Foundrymen to Seek Uses for Foundry Waste

Penn State's Metal Casting Center (MCC) has been tapped by the Environmental Protection Agency to lead a national, industrywide effort to reuse sand and other residuals from foundries in highway construction, cinder and fill. The effort also is receiving support from Pennsylvania's Ben Franklin Program and the Pennsylvania Foundrymen's Association.

In 1991, U.S. foundries spent more than \$480 million to dispose of nonhazardous waste materials—primarily sand, slag and dust. Using an average sand-disposal cost of \$30 per ton and a transportation cost of \$10 per ton, reuse of only 50 percent of the total disposed solid wastes represents an annual cost savings to the industry of about \$133 million. **EP**

1995 Environmental Index

Above Ground Storage Tanks

- *Secondary Containment and Leak Detection: A Great Marriage*, by Wayne B. Geyer and Wayne A. Stellmach, **April 1995**, p. 34.
- *Case Study: Applied Secondary Containment and Leak Detection*, by K. W. Wyatt and M. D. Webber, **Sept. 1995**, p. 29.
- *Leak Detection: A Review of Requirements and Technologies*, by James Wolford, **Oct. 1995**, p. 29.

Air Pollution Control

- *In-Line Flow Control Blocks Risky Leaks*, by William A. Nolan, **Jan. 1995**, p. 45.
- *Biofiltration Holds VOCs, Odors at Bay*, by Kennan Vembu and C. Stow Walker, **Feb. 1995**, p. 27.
- *Air Dispersion Models: Regulatory Applications and Technological Advances*, by Mark Miller and Robert Liles, **Sept. 1995**, p. 34.
- *Good Neighbor Monitoring*, by Donald F. Schukraft, **Nov. 1995**, p. 28.
- *Hot Stuff Controls for VOC Emissions*, by Peter Yewshenko, **Dec. 1995**, p. 11.

Auditing

- *The Corporate Environmental Audit: Will EPA's New Policy Finally Level the Playing Field?* by Stephen L. Kass and Jean M. McCarroll, **June 1995**, p. 45.

Bioremediation

- *The Biofeasibility Study: Key to Successful Bioremediation*, by Michael Chaparian, **July 1995**, p. 10.
- *Case Study: Bioremediation on a Big Scale*, by Michael E. Miller, **July 1995**, p. 15.

Biosolids

- *Texas Rangeland Profits from NYC Biosolids*, by Bob Carlile, **May 1995**, p. 32.
- *Sludge Reuse: The View from the Top*, by Alan Rubin, **Oct. 1995**, p. 34.

Clean Air Act

- *Options for Gas Flow Measurement*, by Paul S. Farber, **Jan. 1995**, p. 15.
- *Air Compliance Goals to Crystallize in 1995*, by Kenneth A. Reich, **Jan. 1995**, p. 20.
- *EPA's EM Rule: Gone Too Far?* by Scott H. Segal, **April 1995**, p. 28.
- *Beyond Title V: Long-Term Air Issues*, by Joseph Curren, **June 1995**, p. 10.
- *Building Flexibility into your Title V Permit*, by Raymond Allen, **June 1995**, p. 15.
- *Air Permits for Wastewater Plants?* by Jerry Bauer and Laura McGovern, **June 1995**, p. 21.

- *Case Study: Navigating the Title V Permit Process*, by Erich Nolan, **June 1995**, p. 25.
- *Salvation or Straightjacket: Title V's 'Synthetic Minor' Option*, by Uday Patankar and Kristian Witt, **June 1995**, p. 31.

Clean Water Act

- *Newsmaker Interview: Progress or Peril—Two Views on CWA Reauthorization*, **Sept.**

1995, p. 38.

- *EP Reader Survey: Clean Water Act Reauthorization*, by Beth Cahape and Steve Davies, **Sept. 1995**, p. 44.

Compliance Issues

- *Regulatory Reform: The View From The Industry*, by Fred Webber, Gene Godley and Henson Moore, **Mar. 1995**, p. 22.

The Last Pollution Control System You'll Ever Have To Buy

Catalytic Systems for Air Pollution Control

- **ADCAT™ CO** Oxidation Catalyst
- **ADCAT™ VOC** Oxidation Catalyst Systems and Catalyst
- **SCONOx™** Combined NOx/CO Catalytic Absorber System
- **Clear View™ CEMS** Continuous Emission Monitoring Systems

Reach the Goal Line

Goal Line Environmental Technologies
2045 E. Vernon Avenue, P.O. Box 58324
Los Angeles, California 90058
Tel. (213)233-2224, FAX (213)233-7428



GOAL LINE
ENVIRONMENTAL TECHNOLOGIES

1995 Editorial Index

■ *Preparing a HON Compliance Program*, by David Seifert, **Mar. 1995**, p. 30.

■ *Fugitive Emissions Monitoring: Building an Inspector-Proof Program*, by John Bacon, **Mar. 1995**, p. 36.

■ *Enhanced Monitoring: A Compliance Primer*, by Daphne V. Economy, **April 1995**, p. 31.

■ *Guest Commentary: Region 1's Contract—Less Enforcement, More Partnership*, by John P. DeVillars, **June 1995**, p. 50.

■ *Care and Feeding of Continuous Emissions Monitoring Systems*, by Wayne E. Reynolds, **July 1995**, p. 19.

Consulting

■ *1995 Consultant's Guide*, **Oct. 1995**, p. 50.

Drinking Water

■ *Using Silicates to Control Lead in Drinking Water*, by Pat Delaney, **May 1995**, p. 27.

Employment Issues

■ *Salary Trends: Buyer's Market Continues for Environmental Professionals*, by Frank Ahaus, **April 1995**, p. 44.

Energy

■ *Flourescent Light Bulbs: Energy Saver or Environmental Hazard?* by Steven Christenson, **Mar. 1995**, p. 59.

Groundwater

■ *Airstripping and Photocatalytic Oxidation: A Winning Team for Groundwater Remediation*, by J. R. Kittrell and C. W. Quinlan, **Sept. 1995**, p. 15.

■ *Low-Flow Purging Management of Contaminated Groundwater*, by Keith Schilling, **Dec. 1995**, p. 24.

Hazardous Materials

■ *Evaluating Hazmat Transporters*, by Lisa Bendixen, **June 1995**, p. 36.

■ *Hazmat Storage Ventilation Codes: The Fine Print*, by Fred W. Romig, **Aug. 1995**, p. 26.

Hazardous Waste

■ *TSD Site Selection: A Three-Model Approach*, by Mark A. Finkelstein, **Jan. 1995**, p. 28.

■ *Changes Ahead for Hazwaste Disposal*, by Eli Eilbott, **May 1995**, p. 44.

■ *Sham Disposal Operations on the Rise*, by Terri Rayer, **May 1995**, p. 52.

■ *Standardized and Customized pH Neutralization Systems*, by Ed Santos, **Dec. 1995**, p. 16.

Health and Safety Issues

■ *Methyl Bromide Users Search for Science*, by Eric D. Winegar, **Jan. 1995**, p. 60.

■ *EPA's Building Air Quality Alliance: Should You Join?* Interview with EPA's Bob Acelrad, **May 1995**, p. 36.

■ *The Right Respirator: An Overview*, by T. Rick Irvin, Stanley J. Campbell, Camilo Cruz-

Batres, Gerald J. Kettler, Philip T. Underhill and Clyde B. Strong Jr., **Nov. 1995**, p. 15.

■ *OVA Readings: Useful Tool or Misleading Information?* by Michael J. Capacci and Mark S. Wilcove, **Nov. 1995**, p. 31.

Insurance

■ *Incentives, Insurance Options Spur Brownfield Redevelopment*, by Robert Hallenbeck, **Mar. 1995**, p. 45.

International Issues

■ *Global Perspectives: Justice for Health New Rallying Cry*, by Whitman Bassow, **Feb. 1995**, p. 11.

■ *Global Perspectives: Environmental Liability in the EU*, by Leonard R. Olsen Jr., **May 1995**, p. 66.

Laboratory Issues

■ *Lab Technologies Migrate to the Field*, by Richard A. Hovan and G. Vinson Hellwig, **Feb. 1995**, p. 14.

■ *Methylene Chloride Regulations Will Impact Laboratories*, by Perry Goldschein, **Feb. 1995**, p. 18.

■ *Choosing the Right Laboratory*, by Craig Eastwood, **Feb. 1995**, p. 21.

■ *Risk Analysis Testing Laboratories: Reducing the Costs of Corrective Action*, by Jeff Simms and Michael Taylor, **Oct. 1995**, p. 20.

Legal Issues

■ *An Exception to Court Rule*, by Bert Black and Lynn Strott, **Jan. 1995**, p. 26.

■ *Legal Watch: Building Owners Face New Asbestos Requirements*, by Bert Black and Donna Rodney, **April 1995**, p. 40.

■ *'Post-Cleanup Stigma' Claims: It Can Happen to You*, by Bradford D. Roth and Neville M. Bilimoria, **June 1995**, p. 52.

■ *How to Respond to Inquiries from Government Lawyers*, by Carol R. Boman, **July 1995**, p. 33.

■ *Legal Watch: Faster, Fairer Cleanup Procedures on the Way for EPA?* by Carol R. Boman, **Sept. 1995**, p. 43.

■ *Legal Watch: Pollution Prevention—EPA and Industry at a Crossroads*, by Carol R. Boman, **Oct. 1995**, p. 66.

■ *Legal Watch: New Recovery Cases*, by Carol R. Boman, **Nov. 1995**, p. 38.

Management

■ *Waste Determination: A New Use for MSDS*, by Jon Seveny, **Mar. 1995**, p. 60.

■ *Case Study: Management Commitment Essential to Ensure Compliance*, by Kevin Iglii, **April 1995**, p. 50.

■ *Guest Commentary: ISO 14000—Good Business Sense Even for Smaller Firms*, by Glenn Nestel, **Aug. 1995**, p. 37.

■ *Management Trends: Measuring Environ-*

mental Performance, by Kyle Datta, **Aug. 1995**, p. 39.

Oil

■ *Brushing up on Oil Recovery*, by Jim Mackey, **Dec. 1995**, p. 20.

Pollution Prevention

■ *Guest Commentary: New Permit Emphasizes Pollution Prevention*, by Richard J. Kogan, **Mar. 1995**, p. 20.

■ *Pollution Prevention: State Programs Help Light the Way*, by Kent Dunn, **April 1995**, p. 38.

■ *Emission Credits: Sell 'Em if You Got 'Em*, by Steve Davies, **Oct. 1995**, p. 19.

RCRA

■ *Enforceable Agreements: Has Their Time Come?* by Steve Davies, **Nov. 1995**, p. 42.

Remediation

■ *DOE's Savannah River Site: A Test Bed for Cleanup Technologies*, by Dr. Terry C. Hazen, **April 1995**, p. 12.

■ *Public-Private Partnering Gains Success Stories*, by Jessica Cogen, **April 1995**, p. 18.

■ *Using Ozone to Speed Up Air Sparging*, by Christopher H. Nelson, **April 1995**, p. 22.

■ *Case Study: Vacuum Extraction Harnessed for Emergency Cleanup*, by Michael J. Costa, **April 1995**, p. 25.

■ *Site Recycling: From Brownfield to Football Field*, by Charles Lee and William L. Haas, **July 1995**, p. 24.

■ *Extraction Chemistry Goes Deep to Grab PCBs*, by Michael V. Bonem and Ronald E. Borah, **Dec. 1995**, p. 14.

Risk Assessment

■ *States Try Their Hand at Prioritizing Risks*, by Steve Davies, **June 1995**, p. 56.

■ *A Consultant's Guide to Reducing Liability Risk*, by Paul T. Carroccio, **Oct. 1995**, p. 41.

■ *EPA's Risk Management Program: Don't Ignore It*, by David Heinold, **Oct. 1995**, p. 24.

Soil

■ *Direct Push Technology: Concept Comes of Age*, by Richard D. Saunders, **Jan. 1995**, p. 37.

■ *Thermal Treatment of Polluted Soil*, by Helen Hodges and Steven K. Wells, **Feb. 1995**, p. 36.

Software

■ *Bringing Together Pictures and Words*, by William Douglas, **Jan. 1995**, p. 40.

■ *Hazardous Materials Software Guide*, by Terri Rayer, **Mar. 1995**, p. 50.

■ *Annual Air Software Guide*, **Aug. 1995**, p. 29.

■ *Annual Water Software Guide*, **Sept. 1995**, p. 24.

■ *Annual Hazardous Waste Software*
continued on page 73

Michael Byrne

Our 30 years of manufacturing experience make us your best buy for quality, dependability and service after the sale.

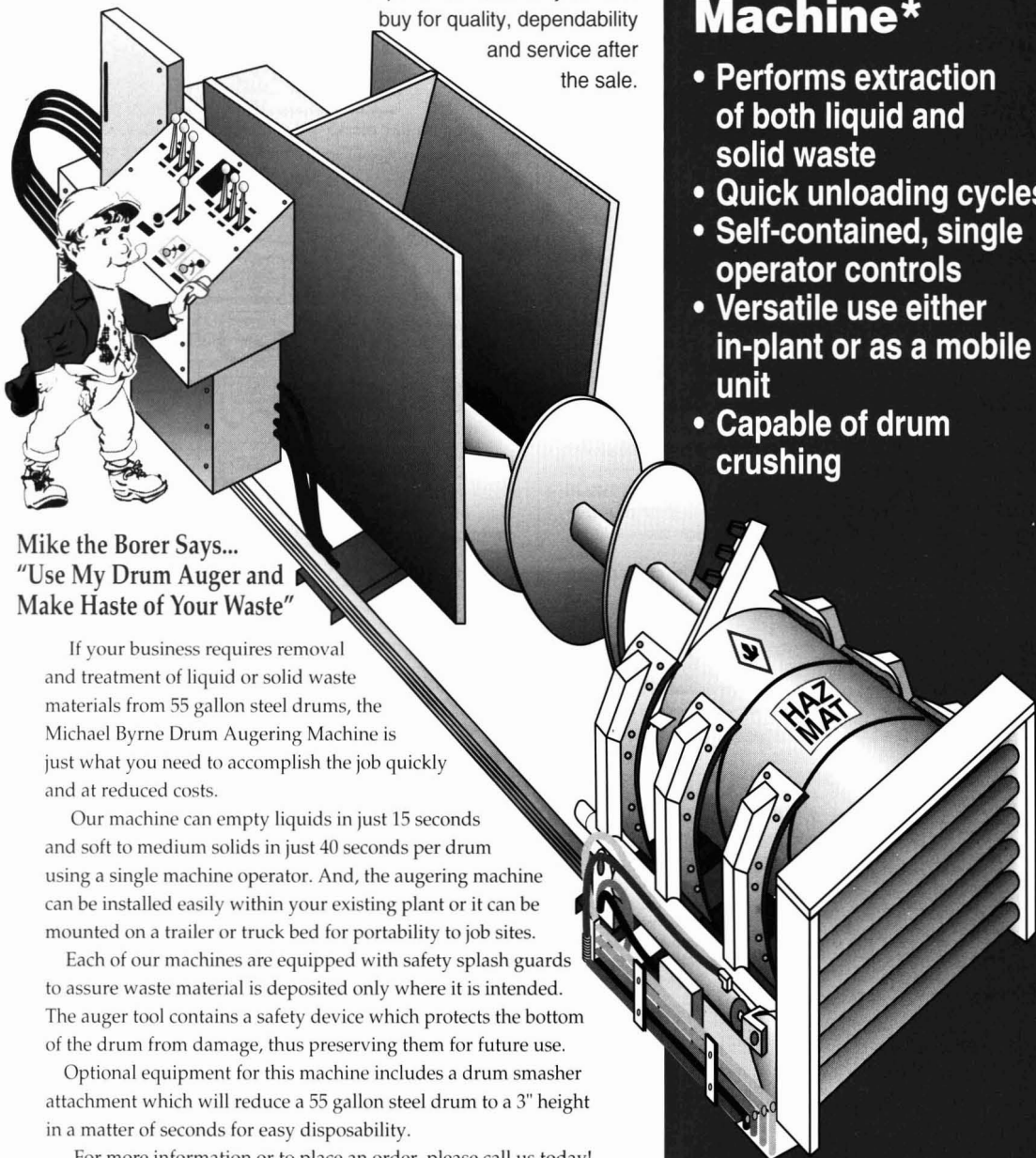

**Mike the Borer Says...
"Use My Drum Auger and
Make Haste of Your Waste"**

If your business requires removal and treatment of liquid or solid waste materials from 55 gallon steel drums, the Michael Byrne Drum Augering Machine is just what you need to accomplish the job quickly and at reduced costs.

Our machine can empty liquids in just 15 seconds and soft to medium solids in just 40 seconds per drum using a single machine operator. And, the augering machine can be installed easily within your existing plant or it can be mounted on a trailer or truck bed for portability to job sites.

Each of our machines are equipped with safety splash guards to assure waste material is deposited only where it is intended. The auger tool contains a safety device which protects the bottom of the drum from damage, thus preserving them for future use.

Optional equipment for this machine includes a drum smasher attachment which will reduce a 55 gallon steel drum to a 3" height in a matter of seconds for easy disposability.

For more information or to place an order, please call us today!



1-800-613-7206

Circle 54 on card.

**Drum augering machine
can be mounted on a truck
or trailer for portability to
job sites.**

Model MBDA-200 Drum Augering Machine*

- Performs extraction of both liquid and solid waste
- Quick unloading cycles
- Self-contained, single operator controls
- Versatile use either in-plant or as a mobile unit
- Capable of drum crushing

- Built-in safeguards
- Designed and engineered for durable, long life

* patent pending

EP Exclusive

Environmental Data Management Software

Pacific Environmental Services announces the availability of release 3.2 of its industry-leading i-**STEPS** environmental data management software system. The system includes two new modules—Solid/Hazardous Waste and Wastewater, and an enhanced version of Air Module. The Solid/Hazardous Waste Module allows users to manage information on hazardous and non-hazardous wastes according to RCRA requirements from the time of generation to ultimate disposal. The Wastewater Module enables users to automatically complete discharge monitoring reports required by NPDES permit conditions or by applicable local limits. It manages wastewater discharge data at the process and/or facility level. The

enhanced Air Module includes more than 15 new features, including: improved interface with builder functions and text descriptions on all buttons, improved maneuvering, and enhanced data management with scientific notation.

Each module may be used separately or combined to form a comprehensive, multimedia data management system. The software enables the user to create, track and maintain an inventory of environmental media, as well as support a full range of reports and permit applications. i-**STEPS** is used to prepare annual emissions reports, track emissions for demonstrating daily compliance, support Title V applications and generate EPCRA/SARA Title III, Form R reports. **Pacific Environmental Services Inc.**

Circle 120 on card.

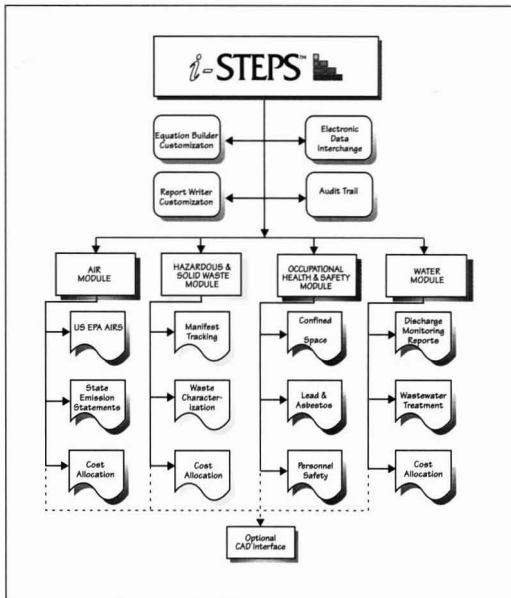

MAKE A DEWATERING & SLUDGE SEPARATING FILTER OUT OF YOUR CONTAINER

Permanently Mounted or Removable Vertical Panel Filter: A retrofit for all conventional sized roll-off sludge containers.

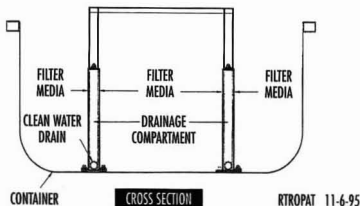
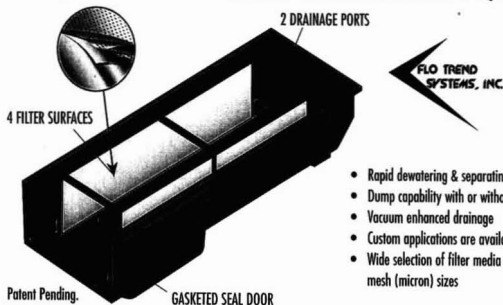

A simply designed vertical panel filter that will convert any conventional container or dump truck into an efficient and effective dewatering and separating container. This conversion can be made with little or no change to your existing inventory by: 1) installing slide lock ratchets on the walls of the container and 2) providing two outside drainage ports for the clarified water. A hose yoke and vacuum pump may be used with the Vertical Panel Filter without any alterations to the container. Call us for a demonstration or pilot study.

FLO TREND SYSTEMS • 707 LEHMAN • (713) 699-0152 • FAX: (713) 699-8054

MP101A Meteorological Probe with C94 Humidity Sensor for High Pollution Environments

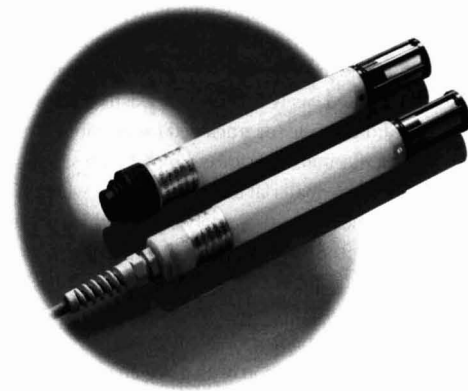

- ROAD WARNING SYSTEMS
- INDUSTRIAL EMISSION MONITORING
- AGRICULTURAL CHEMICAL SPRAYING

rotronic
instrument corp

160 E. MAIN STREET, HUNTINGTON, NY 11743
516-427-3898 • FAX 516-427-3902 • 1-800-628-7101



Treatment System

This wastewater treatment system eliminates off-site disposal and discharge permits. Coalescing separator and Submerged Combustion Evaporator produces 98 percent reduction of wastes. State-of-the-art system combines oil separation, VOC destruction and evaporation to eliminate waste streams. **U.S. Environmental Engineering.**

Circle 121 on card.

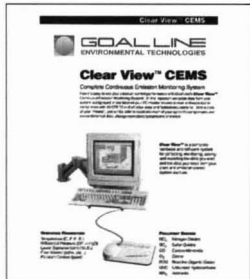

Continuous Emission Monitoring System

Goal Line's Clear View CEMS lets you monitor and save emission data from your process in order to record, analyze and report emission control performance. Data is displayed in real time on your monitor and recorded in compliance with 40 CFR 75 and other state and federal regulations. **Goal Line.**

Circle 122 on card.



Fiber Optic Infrared Transmitter

The OS1553 is a self-contained fiber optic infrared transmitter with a linear 4 to 20 mA output for monitoring, datalogging, or controlling temperature

or products via non-contact surface temperature measurements. Takes measurements where direct line of sight is not possible and in very high energy fields. **Omega.**

Circle 123 on card.

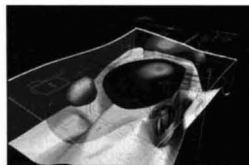

True Volume Modeling

Voxel Analyst (VA) software provides true volume modeling, analysis and visualization for 3D distributed data. Allows Boolean analysis and interactive manipulation of volume data. Multi-threading enables graphics display and computation to be done simultaneously on multi-processor machines. **Intergraph.**

Circle 124 on card.



Ultra Resi-Analyzed Solvents

Ultra Resi-Analyzed extraction solvents for environmental testing in the Cycle-Tainer system is a closed solvent dispense unit that preserves solvent purity and stability. Utilizing an inert gas to propel the solvent to the point of use, it eliminates the solvent's exposure to harmful vapors. **J. T. Baker.**

Circle 125 on card.

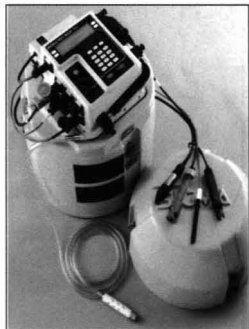

Compliance Monitoring

The 900 MAX Sampler can be programmed to activate sampling when internally logged parameters deviate from user defined limits. Ideal for parameters such as pH, temperature, ORP, dissolved oxygen and conductivity. Users can set high and low trip points to activate sampling and confirm a violation. **Sigma.**

Circle 126 on card.

ENVIRONMENTAL LIABILITY INSURANCE

- Asbestos Abatement
- Lead Abatement
- UST Removal
- Hazwaste Remediation
- Consultants & Labs

Workers' Compensation* Contract Surety Bonds*



*Insuring The Environment**

Rated A- (Excellent)

by A.M. Best

(800) 388-3647

1900 The Exchange, #450
Atlanta, GA 30339

* Provided by independent carriers

Circle 60 on card.

PIT HOG® pumps sludge fast.

LWT pumping systems move heavy sludge, sand, silt, residuals and debris from lagoons, tanks, vessels and digesters.

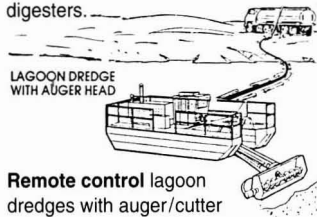

Remote control lagoon dredges with auger/cutter heads fill tankers and feed booster pumps or dewatering equipment.

Diesel or electric hydraulic power—free standing or mounted on floating systems. Soft start/stop for variable flows and pressures. We design and build specialized equipment to fit your needs. Buy or rent Pit Hog systems.

Call or write for Free Literature.

LWT & LIQUID WASTE TECHNOLOGY

Box 250, 422 Main St, Somerset, WI 54025
FAX 715-247-3934 • Phone 715-247-5464
CALL TOLL FREE 1-800-243-1406

Circle 62 on card.

THE FIRST GC/MS DESIGNED FOR SITE SEEING.



Introducing HAPSITE™, the first portable GC/MS that lets you see the answers before you leave the site.

VOHAPs analysis just got easier, and quicker, and less expensive, and less time consuming, and more reliable.



No, it's not too good to be true. It's what the industry has been waiting for—the first truly field-portable instrument to provide on-site analysis of VOHAPs.

HAPSITE literally changes the way VOHAPs analysis is done. Battery-powered, lightweight and weatherproof, this new instrument will accurately speciate and quantify VOC emissions right on the spot, giving you the certainty that your field crew will only have to test once.

And it's easy to use. HAPSITE doesn't require any special knowledge of mass spectrometry, because an internal processor interprets and displays



the results. It's self-tuning, too, so the field operator doesn't tune or calibrate the GC/MS. Using built-in internal standards, HAPSITE ensures accurate calibration for greater confidence in test results.



HAPSITE also offers total flexibility for multiple applications. It can be used in a survey mode (MS only) for fast screening, or in a GC/MS mode when confirmatory results are required. In either mode, it has full scan or SIM capability.

And it's *only* available from Inficon, a world leader in the design and manufacture of analytical instruments.

If you're involved in VOHAPs analysis, now you can spend a lot less time site seeing.

Call 1-800-223-0633 for more information.



OPENING THE FIELD TO NEW IDEAS™

INFICON®

PRODUCTS & SERVICES



Version Two Software Program

New catalog available on disk version two, featuring the OBF Series. The series is constructed in stainless steel and is available in 3 inch or 4 inch connections. Version two is an interactive software program that makes specifying an automatic self cleaning water filter simple. **Automatic Filters Inc.**

Circle 127 on card.

Ultrasonic Level Transmitter

This ultrasonic level transmitter can be calibrated in less than 90 seconds and is simple enough to learn in minutes with



no special training. No power or meters are required for the two-step procedure. It uses an ultrasonic pulse technology for non-contact, continuous level measurement of liquids at ranges up to 31 feet. **Drexelbrook Engineering Co.**

Circle 128 on card.



Consultant Certification Program

The program was developed in response to requests for consultants to implement and maintain PlantWare, EnviroMetric's environmental data management system. Certification cards are issued to consultants and customers are being encouraged to "Ask for the card!" when speaking to a consultant about implementation services. **EnviroMetrics Software Inc.**

Circle 129 on card.

Conductivity/pH Meter

The Conductivity/pH meter tests water quality in boilers, cooling towers, RO/DI systems,



chemical concentrations and lab analysis. Features a large digital display, a tough polyethylene cell cup, temperature compensation and a built-in pH sensor. **Myron L Company.**

Circle 130 on card.

Fluid Monitoring Versatility

The Liquid-Sense Fluid Monitoring System reduces expensive downtime, damages due to fluid leaks, and dry pumping time due

Site Assessment Software for Windows

Deliver your report in half the time---

THIS MEANS MONEY to YOU!!!

Designed **FOR** the environmental professional.....
BY environmental professionals!

Standardize your report---Save Time and Money!

- ◆ Complete with WYSIWYG word processor for automatic ASTM-compatible report format
- ◆ Customize and print report in the word processor
- ◆ NREP and ASTM reference documents and a Notebook feature for your notes in the field

Call for **FREE Sample Report Environmental Site Assessment.....\$695.00**

softshel, inc. 

P.O. Box 10813, Oklahoma City, OK 73140
 (405) 733-2002

Circle 64 on card.



YOUNG

Meteorological Instruments

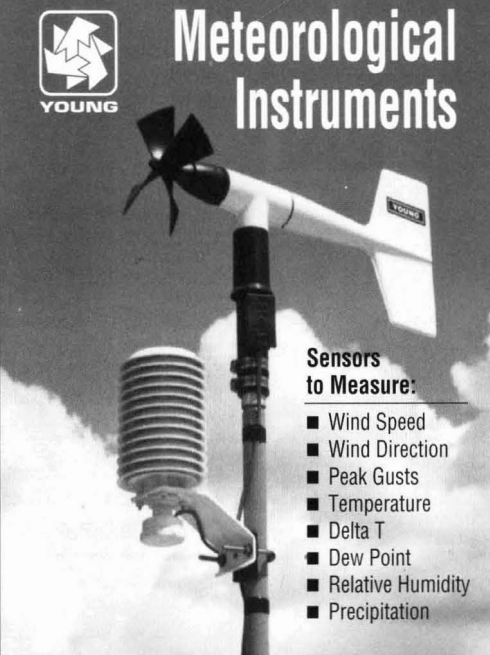

Sensors to Measure:

- Wind Speed
- Wind Direction
- Peak Gusts
- Temperature
- Delta T
- Dew Point
- Relative Humidity
- Precipitation

R. M. YOUNG COMPANY
 2801 Aero Park Drive, Traverse City, MI 49684 U.S.A.
 Tel: 616-946-3980 Fax: 616-946-4772

Circle 65 on card.

PRODUCTS & SERVICES

to out-of-fluid conditions. It sounds an alarm, lights a red LED and switches on backup pumps and systems when a sensor is triggered. **Barnant Company.**

Circle 131 on card.

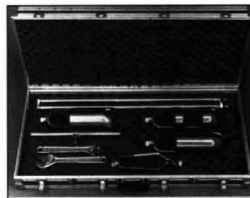

Auger Kits

Four augers (General Purpose, Sand, Clay and Mud) are included in the JMC Professional Auger Kits. Kits can collect soil samples almost anywhere and can be tailor made to fit specific needs. Different diameters and case styles are available. **Clements Associates Inc.**

Circle 132 on card.

Gas Detection Instruments Catalog

Full color, 16-page catalog provides a full line of portable gas detection instruments. Instrument types range from surveys to area sampling to personal monitoring of oxygen, combustible gases and toxic wastes. Applications include confined space entry, fugitive emissions and leak verification. **Bacharach.**

Circle 133 on card.



Groundwater Sampler

The Portable Grundfos Redi-Flo2 System is compact and features high purge rates to 9 gpm and sampling rates as low as 100ml/min. Cart has pneumatic

tires that allow easy transport. Tubing is easy to replace and is mounted in a reel. Has an adjustable height tubing guide to protect cables from sharp edges. **Solinist.**

Circle 134 on card.

Wet Electrostatic Precipitator

Can provide 99% and better



removal efficiency for submicron particles at minimum pressure drop. It utilizes a multiverture section as a pre-cleaning stage. An open hexagonal grid type collector provides a sound design with maximum collector surface area. Comes furnished with high voltage accessories. **Clean Gas Systems Inc.**

Circle 135 on card.



Maximum Hazmat Building Flexibility

Prefabricated Factory Mutual (FM) approved fire and blast rated modular hazmat building that can be expanded with any 2 foot wide increment mid unit.

— UXO FORUM 1996 —

Marriott Williamsburg
Conference Center
Williamsburg, Virginia

March 26-28, 1996

Sponsored By:
Department of Defense
Explosives Safety Board

Hosted By:
U.S. Army Environmental
Center

In Cooperation With:
Naval Explosive Ordnance
Detection Technology Division

U.S. Air Force/Wright
Laboratory

U.S. Army Corps of
Engineers, Huntsville Division

U.S. Army Project Manager
for Non Stockpile Chemical
Material

Western Governors'
Association

The objective of the Unexploded Ordnance (UXO) FORUM 1996 is to draw together a diverse, worldwide audience to exchange information related to UXO issues. These issues include the following:

- UXO policies, procedures, and resources
- Definition of user needs
- UXO technology research, development, demonstration, testing, and evaluation
- Safety and environmental risks associated with UXO contamination
- UXO site remediation

UXO FORUM 1996 will encourage networking and will provide an optimal climate for review and exchange of technical information. The conference will feature an extensive exhibit and poster session open to all attendees.

UXO FORUM 1996

PRC Environmental Management, Inc.
644 Linn Street, Suite 719
Cincinnati, Ohio 45203
(513) 241-0149
(513) 241-0354 (fax)

YES! I am interested in attending the UXO FORUM 1996. Please send me complete information.

My company is interested in exhibiting. Please contact me.

Name _____
Title _____
Company _____
Address _____
City _____
State _____ Zip Code _____
Phone _____
Fax _____

CLIP OUT AND MAIL

CLIP OUT AND MAIL

Patented floor and roof caps keep chemical spills inside and rain outside. Custom sizes up to 14 foot wide by 70 feet long by 16 feet high. **Haz-Safe Buildings by Design.**

Circle 136 on card.



Pre-conditioning Sludge Process

Class A bio-solids can be produced from existing wastewater treatment operations using a fully automated, pre-conditioning sl-

udge process applied before anaerobic digestion, offering savings in disposal costs. Also increases the capacity of existing digesters and enhances the dewaterability of biosolids. **Envirex.**

Circle 137 on card.



CD Finds Regulatory Information Fast

Research Assistant locates topics in federal government, safety and transportation regulations from all 50 states with a single search command. Allows users to search using the Boolean search logic. Offers several pre-set groups, but users can create custom groups. **RegScan Inc.**

Circle 138 on card.

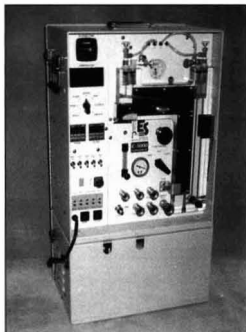

Source Sampler

The C-5000 Source Sampling System features dial-type solid state temperature controllers for probe and filter, digital LED or LCD temperature readout, dual inclined manometer with manual shut-off valves and brass fittings. Provides customization of design to fit your isokinetic sampling needs. **Environmental Supply Company Inc.**

Circle 139 on card.



Continuous Opacity Monitor

The EMS 1302 double pass C.O.M. uses an advanced multi-lens transceiver with electronically modulated lamp and photopic response. Features include thru the lens alignment, on-line zero and span, and stack exit correlation. **Environmental Monitor Service Inc.**

Circle 140 on card.

Ultrasonic Level/Flow Measurement

HydroRanger Plus is designed to offer ease of operation and pro-

INTRODUCING THE ALL NEW...

TRIBOGUARD SERIES OF BAGHOUSE MONITORS

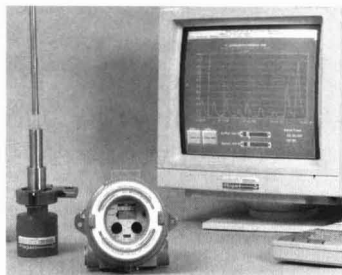

The analog **TRIBOGUARD II** system is available with a 4-20mA output and **PRE-VENT**® the new Dual Alarm system that gives you an early warning alarm *BEFORE* a high emission is reached. The all new design will meet the requirements of Parametric Monitoring, so maintenance can use it to reliably detect broken bags, while the plant Continually Demonstrates Compliance. Ask about **Auburn's** new **PC Communications & Software** which will help you not only log data, but also **LOCATE** the failed filter in your dust collector. Produced by the pioneers in Triboelectric Technology.

auburn INTERNATIONAL

Eight Electronics Avenue, Danvers, MA 01923
1(800) 255-5008 FAX: (508) 777-8820

Circle 67 on card.

Down-Hole Conductivity Profiler!



The C4 Conductivity Profiling Sleeve offers the best of both worlds. It turns the sturdy, everyday Model 101 Water Level Meter into a conductivity profiler when needed. Depth is read from the accurate, permanently marked tape, and conductivity from an analog readout which plugs into the Water Level Meter faceplate. Temperature profiling sleeve is also available.

- **Sturdy Model #101**
- **The industry favourite Water Level Meter**
- **Easy attachment of profilers**
- **Lengths to 1500 ft. (450m)**
- **Low maintenance design; easy to calibrate**
- **Reads 0-80,000 µS/cm, on one scale**

Solinst

High Quality Groundwater Instrumentation

Tel: (905) 873-2255, (800) 661-2023; Fax: (905) 873-1992

Circle 68 on card.

PRODUCTS & SERVICES



vide reliability in harsh environments. Advantages are control capabilities, including energy saving pump control, pump service ratio predetermination and rate pumping. **Milltronics.**

Circle 141 on card.

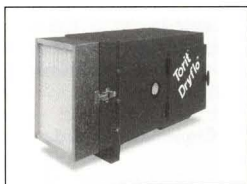

Mountable Mist Collector

The Torit DryFlo Mist Collector is now available in a com-

compact design that can be mounted directly on a machining center. It is engineered specifically for collecting coolant and oil mist from wet machining operations. **Donaldson Company, Inc.**

Circle 142 on card.



Temperature Programmable Oven

The HNU 311D portable gas chromatograph now features a temperature programmable oven that operates from ambient up to 200 degrees Celsius. Other features include a totally automated gas sampling system, a choice of three detectors, and the ability to

run any two detectors simultaneously in series or in parallel. **HNU Systems Inc.**

Circle 143 on card.

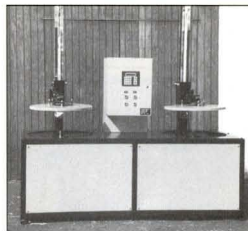

Drum and Pail Washer

This family of automatic drum and pail washers features high-pressure pumps with pneumatically motorized spray balls, which clean all surfaces with a jet spray of up to 150 psi. Models are available to wash interior and exterior using solvents and aqueous fluids. **SRS Industrial Engineering Inc.**

Circle 144 on card.

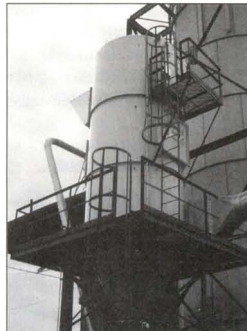

Brochure on Reverse Air Filter

A six page, full-color brochure on the new Reverse Air Filter III contains performance data on the new filter which combines reverse air cleaning, cyclonic separation and new high-efficiency filter cartridges in a more compact space. Brochure highlights features and benefits. **Pneumafil Corporation.**

Circle 145 on card.

Does it seem like there is always something out there taking a bite out of your profits?

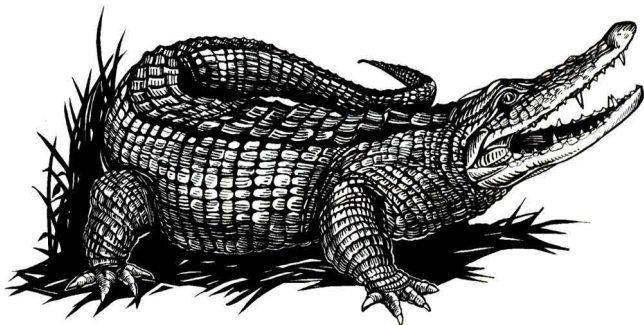

If you don't have coverage with the Fund, you might want to ask your agent to call this number—it's the Fund Information Line (800) 859-5995

The biggest bite can almost always be attributed to workplace accidents. Bite back—control your losses by working together with the loss prevention specialists at the **Texas Workers' Compensation Insurance Fund.**



Helping Build a Stronger Texas



Brochure on Secondary Containment Products

A six-page, full-color brochure describes and illustrates a line of products and systems for primary and secondary containment of underground fuel storage. Features flexible piping systems, including Enviroflex, a double wall retractable system. **Total Containment.**

Circle 146 on card.



Safety Information Software

Inmagic DB/TextWorks, a textbase software featuring unlimited-length fields, repeating fields, integrated image management, full-export text, and a WYSIWYG drag-and-drop report writer. Suitable for managing MSDSs and processing safety information. **Inmagic Inc.**

Circle 147 on card.

Floating Confined Space Entry Monitor

The Triple Plus is a portable, multi-gas monitor that floats in liquids and can simultaneously monitor up to four different gases with any combination of oxygen, combustible gas and



Photometric Test Kit

The Vacu-vials test is a one minute procedure that simplifies the monitoring of chlorine in drinking water in the 0-4 ppm range. The new kit features reagent ampoules which contain a unit dose of the DPD reagent and is EPA-approved for drinking water data reporting in many states. **CHEMetrics.**

Circle 149 on card.

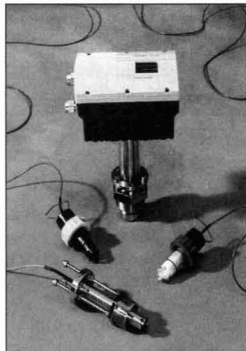

"Hot Tap" Sensors

A new expanded line of SIGNET insertion flow sensors is available in a variety of materials, including applications involving gravity flow lines and low-flow velocities. Sensors are easy to install, require little or no maintenance and provide a highly repeatable signal. **George Fischer Inc.**

Circle 150 on card.

Oil Skimmer

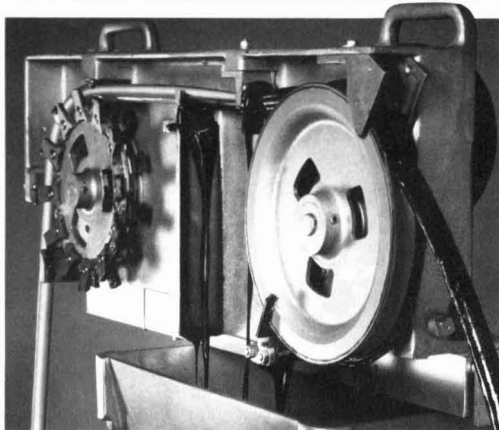

Simple, Efficient Waste Oil Recovery

Oil Skimmers oil recovery systems remove waste oil from water and pipe it into a drum. The systems work in any industry where floating oil is a problem. Uncomplicated, dependable, maintenance-free, Oil Skimmers systems are engineered to operate continually and unsupervised, 365 days a year.

If floating oil is causing you a problem, call Oil Skimmers, Inc. collect at **216/237-4600**. Find out how simple, efficient and profitable waste oil recovery can be.



P.O. Box 33092 • Cleveland, Ohio 44133 U.S.A.

Circle 70 on card.



Remote Location Logistics & Support

- ▲ Temporary Decon & Washdown Systems
- ▲ Portable Buildings
 - ~ Temporary Storage
 - ~ Field Labs
 - ~ Warehousing
 - ~ Equipment Enclosures
- ▲ Portable Berms & Storage Tanks
- ▲ Drill Rig Enclosures



Exploration Products

509-927-8101 ▲ 800-448-7312
FAX 509-927-8559

CALL FOR YOUR FREE CATALOG

Circle 71 on card.

PRODUCTS & SERVICES

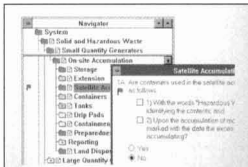

Auditing Software

Dakota Auditor for Windows allows companies to efficiently determine regulatory applicability, audit for compliance and do regulatory research and management training. Features three interactive windows and allows access at a glance to all the regulatory information that applies to a facility. **Dakota Software Corporation.**

Circle 151 on card.

Scanning Hot Spots

The new Gamma Scanner is a scanning survey system to locate and characterize gamma emitting material from a remote location. The scanner provides informa-

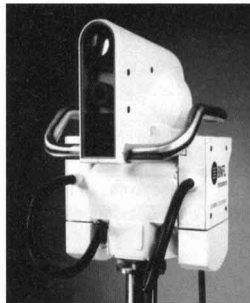

tion on the location, activity and isotopic composition of materials and contamination. **BNFL Instruments.**

Circle 152 on card.

Fully-Improved Models

The American Society of Sanitary Engineering has approved Flomatic's Pressure Vacuum Breaker Assembly in sizes ranging from 3/4 inch to 1 inch. The new assembly incorporates an independently acting check valve



with a spring-loaded float disc. Features include corrosion resistant parts, replaceable seats, durable silicone seat discs and fewer internal parts. **Flomatic.**

Circle 153 on card.



Hazmat Vacuum Cleaner

Wet/Dry is an industrial portable vacuum cleaner designed for industrial plant clean-up, barge

and rail car cleaning—suitable for cleaning hazardous materials. This heavy duty, industrial vacuum cleaner is available in two models of three and six cubic yard tank holding capacities. **General Resource Corp.**

Circle 154 on card.

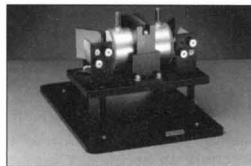

Compact Volume Gas Cell

The new Micro Lightpipe Gas Cell is a small, compact gas cell for FT-IR spectrometers. The cell is for Mid-IR use and has an effective pathlength of 0.5 meters. It provides higher sensitivity and allows measurements of many gases in the parts-per-million range. **Spectra-Tech Inc.**

Circle 155 on card.

Haz-Safe™ First with...



LARGEST **FM** **BUILDINGS**
APPROVED

- **24" Design System™** up to 14' widest x 70' longest x 16' highest buildings saving real estate with multiple rooms instead of individual sheds, and better use of vertical space.
- **Modular Building System™** for unlimited size and expansion with sump/roof caps and concealed fasteners.
- **Protected Crown and Cradle™** 1/4" thick tubular steel skeleton, porcelain enameled steel interior, 1-4HRFR exceeds all codes.
- **Haz-Safe Mat Handling™** crane hoist inside and overhead doors* for quick loading.



HAZ-SAFE
Buildings by Design

a division of
CID Associates, Inc.
PH: (412) 842-2130
FAX: (412) 845-7834
P.O. Box 606

Leechburg, PA 15656-0606



* U.S. Patent 5,191,942,
5,285,617, 5,301,479
5,396,742 Others Pending

Emission measurement

testo

NO
NO₂
SO₂
CO
O₂
CO₂
Excess Air
°C/°F
Efficiency
ΔP
H₂O
%RH
fpm



NEW:

- ISO 9001 certified.
- Approved by the Southern California EPA (SCAQMD).

Affordable Emission Tests!

...with the **testo 350** portable emission analyzer. Achieve EPA compliance at a fraction of the normal costs.

- Checks and reports emissions according to certain EPA requirements.
- Pre RATA tests to eliminate costly second audits.
- With H₂O and Velocity modules.
- Windows software to calculate emissions (t/y or lb/h).
- Field test gas calibrations on selected ranges.

Testo Inc.

230 Rt. 206 • Flanders NJ 07863
Tel. 800-227-0729 • Fax 201-252-1729

1995 Editorial Index

continued from page 62
Guide, Dec. 1995, p. 22.

Stormwater

■ *Stormwater Trials and Tribulations: Industry Impressions*, by Nancy E. Gardiner and Jennifer A. Cohen, May 1995, p. 14.

Superfund

■ *Guest Commentary: Superfund in the Age of Newt: What do we do Now?* by Thomas F. Harrison, May 1995, p. 61.
■ *Regulatory Trends: Superfund up for Overhaul—or Tweaking*, by Steve Davies, Sept. 1995, p. 46.

Technology

■ *Technology Profile: Air Modeling/Monitoring Products*, June 1995, p. 28.
■ *BioFiltration: Weighing the Technology's Cost-Benefits*, by W. Michael Griffin and Stephen W. Paff, July 1995, p. 17.
■ *Technology Profile: Continuous Emissions Monitoring Systems*, July 1995, p. 22.
■ *Commercialization Hurdles Slow Technology Developers*, by Steve Davies, July 1995, p. 28.
■ *Small Business Technology Program*

Promotes Innovation, by Steve Davies, July 1995, p. 37.

■ *Technology Profile: Industrial/Municipal Filtration Systems*, by Beth Cahape, Aug. 1995, p. 20.

Toxic Substances Control Act

■ *Guest Commentary: Subduing Toxicity with TSCA Reform*, by Warren R. Muih, Feb. 1995, p. 44.

Training

■ *Review, Reconsider Your Presentation*, by Michael Cherniak, Jan. 1995, p. 53.
■ *More Environmental Resources on the Internet*, by Kenneth C. Taylor, June 1995, p. 58.
■ *Developing an Effective Environmental/Safety Committee*, by Carol Kefford Eshelman and Craig A. Woodacre, July 1995, p. 35.
■ *Environmental Training for Corporate Risk Managers: Addressing a Growing Need*, by T. Rick Irvin and Camilo Cruz-Batres, Aug. 1995, p. 22.
■ *You Want to Do What?* by Carol Kefford Eshelman and Craig A. Woodacre, Sept. 1995, p. 49.
■ *Changing Goals in Environmental Train-*

ing, by Carol Kefford Eshelman and Craig A. Woodacre, Oct. 1995, p. 14.

■ *The Elements of Training*, by Carol Kefford Eshelman and Craig A. Woodacre, Nov. 1995, p. 40.

Wastewater

■ *Sewer Overflows and Waste Debris*, by Frank J. Sudol, Feb. 1995, p. 33.
■ *Zero Discharge: More Than a Pipe Dream?* by Ed Kobylinski, Mar. 1995, p. 55.
■ *New Frontiers in Wastewater Treatment*, by John L. Knott, Jr., May 1995, p. 20.
■ *Dechlorination Alternatives*, by Samuel L. Bean, May 1995, p. 25.
■ *Case Study: Odor Warfare in an Urban Setting*, by Richard J. Pope, Dominick P. Profaci and Alfonso Lopez, Aug. 1995, p. 11.
■ *Membrane Separation: Filters to the Rescue*, by Beth Cahape, Aug. 1995, p. 18.
■ *Wastewater Treatment: New Technologies Lowering Treatment Costs*, by Beth Cahape, Sept. 1995, p. 10.

Wetlands

■ *Cattails Treat Leachate and Save Thousands*, by Ellen Carnevale, Nov. 1995, p. 35.

PRODUCT LITERATURE

THIS DEPARTMENT CONTAINS...

Descriptions of products from a variety of leading companies. To receive FREE literature, simply circle the numbers on the reader service card which correspond to the numbers beneath the products that interest you.

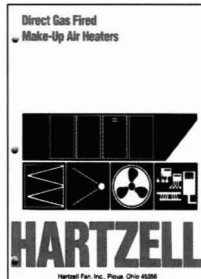

Circle 115 on card.

Make-up Air Heaters

Hartzell Fan's Direct Gas Fired Make Up Air Heaters come in axial, centrifugal and econo models. Certified to ANSI STD Z83.4 or built to IRI or FM specifications, they now come with vertical or horizontal configurations. Axial Models' performance range from 300 through 100,000 CFM with 24" through 85" cast aluminum propeller fans. The Centrifugal models' performance also range from 300 through 100,000 with 15" through 54" DWDI.

Call Hartzell Fan at 1-800-336-3267 and request for Bulletin A-127.

Hartzell Fan, Inc.
910 Downing St.
Piqua, OH 45356-0919



Circle 116 on card.

Instruments Catalog

The free 1995-96 instruments catalog contains over 1,700 full-color pages and features more than 40,000 products covering scientific instruments, equipment and supplies. It includes a detailed 40-page product index, informative introductory pages for several sections, "Hot Tops" and an 8-page section of late-breaking products.

Cole Parmer Instruments Co.
625 East Bunker Court
Vernon Hills, IL 60061
(800) 323-4340
Fax (708) 549-7676

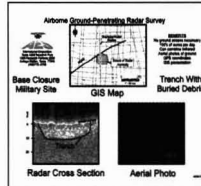

Circle 117 on card.

Airborne Ground Penetrating Radar (GPR) surveys are an excellent tool for site characterization studies. Applications include detection of underground structures, landfills, UXO, and mapping hydrocarbons on shallow groundwater. GPS coordinates, GIS maps and aerial photos for each anomaly. Can cover 100 to 400 acres per day. Excellent for large government and military sites.

AES International Corp.
1500 Research Parkway
Suite 220
College Station, TX 77845
(409) 775-0765
Fax (409) 775-0928

continued on page 161

Nine Applications Suitable For Using Aquastore® Tanks In Wastewater Treatment.



The Town of Colonial Beach, Virginia, 2 mgd wastewater treatment plant features 8 Aquastore tanks. Consultant: Reid Engineering Co., Inc., Fredericksburg, Virginia

Single-use applications:

1. Storm water
2. Equalization
3. Trickling filters
4. Sludge digestion
5. Sludge storage and mixing

Total system applications:

6. SBR (Sequential Batch Reactor) systems
7. Package treatment plants
8. Conventional large volume treatment plants
9. Anaerobic sludge digestion

In many of the above applications, engineers determined Aquastore tanks with Permaglas® coating were an effective alternative to conventional concrete tanks.

For more information on the many uses of Aquastore tanks in wastewater treatment applications, write, call or FAX today.



A.O. Smith Harvestore Products, Inc.
345 Harvestore Drive
DeKalb, IL 60115
815/756-1551 FAX 815/756-7821

Aquastore and Permaglas coating are the registered trademarks of A.O. Smith Harvestore Products, Inc.
© Copyright 1995 A.O. Smith Harvestore Products, Inc.

Circle 76 on card.

Environmental PROTECTION

1996 BUYER'S GUIDE

Products and Services Index	76
Products and Services Directory	78
Company Profiles Directory	128

HOW TO USE THIS GUIDE

PRODUCTS AND SERVICES

For quick and easy reference to a specific product or service, turn to page 76. The Products and Services section is clearly marked and contains alphabetical listings of companies offering various products and services. For your convenience, the listings are divided into detailed categories. You can find additional information by cross-referencing supplier names to the Company Profiles Section of the *Buyer's Guide*.

COMPANY PROFILES

To find details about specific company, turn to page 128. This alphabetical reference section is a valuable resource for readers needing to find listings of companies that sell products and services in the environmental market. Each Company Profile contains in-depth information, including company name, address, phone number and products/services (advertisers only). *Buyer's Guide* advertisers' ad page numbers are listed in bold type under the Company Profile listing.

PRODUCTS AND SERVICES

This section of the **1996 Environmental Protection Buyer's Guide** alphabetically lists companies that market products and services.

For more information, cross-reference the supplier in the company profiles section, beginning on page 128.

Also, *Buyer's Guide* advertisers' ads are listed in bold type with the page numbers of their advertisements.

A	PAGE	Carbon Reactivation	86	Diffusers	92
Aboveground Storage Tanks	78	Carbon Regeneration Systems	86	Digesters	92
Absorption Equipment	78	Cascade Impactors	86	Directories	92
Access Covers	78	Catalysts	86	Disinfection Equipment, Water	92
Acid Rain Gauge	78	Cathodic Protection Equipment	86	Dissolved Oxygen Detectors	93
Acoustical Chambers	78	Centrifuges	86	Dissolved Solids Detectors	93
Activated Carbon	78	Chemical Information	86	Distillation Equipment	93
Actuators	78	Chemical Odor Control	86	Dredges	93
Adsorbent Equipment	78	Chemical Storage Buildings	86	Dredging Services	93
Aeration Systems	78	Chemicals	86	Drilling, Water	93
Aerators/Diffusers	78	Chillers	86	Drum Deheader	93
Aerosol Detectors	78	Chlorination Equipment	86	Drum Pumps	93
Aerosol/Particle/Smoke Generators	78	Chlorine Detectors	86	Drums	93
Agglomerators/Briquetters/Pelletizers	78	Chromatographs	86	Drying Equipment	93
Agiators	78	Clamps, Pipe	86	Ducts/Stacks/Chimneys	93
Air Analyzers	78	Clarifiers	86	Dust Collector Accessories/Supplies	93
Air Classifiers	78	Clarifiers Drive Units	88	Dust Collector Controls	93
Air Dispersion Services	78	Clean Rooms/Supplies	88	Dust Suppression Systems	93
Air Emission Monitoring Equipment	78	Cleaning Equipment/Supplies	88		
Air Emissions Testing	78	Cleaning/Flushing Services	88	E	PAGE
Air Exhaust Noise Control	80	Clothing, Protective	88	Electrodes pH	93
Air Filters	80	Coagulation	88	Electrodes Specific/lon	93
Air Make-up Units	80	Coatings/Linings	88	Electrostatic Precipitator	93
Air Quality Instrumentation	80	COD Instrumentation	88	Electrostatic Precipitator Supplies/Accessories	93
Air Quality Permits	80	Colorimeters	88	Elevators	93
Air Pollution Control Equipment	80	Combustible Gas Detectors	88	Emergency Response Training Services	93
Air Samplers	80	Combustion Control Instruments	88	Employment Services	93
Air Strippers	80	Communication Equipment	89	Emission Monitor Systems	93
Air Velocity Meter	80	Communicators/Grinders	89	Enclosures, Instrument/Valve	93
Alloys	80	Compactors	89	Enclosures, Structural	93
Anaerobic Pretreatment	80	Compliance Audits	89	Engine Test Equipment	94
Analysis, Atomic Absorption	81	Composting Systems	89	Engineering Services	94
Analysis, Electron Microscopy	81	Compressors	89	Engines	94
Analysis, Gas Chromatography	81	Computer Control	89	Environmental Audits	94
Analysis, Gas Chromatography/Mass Spectrometry	81	Computer Databases	89	Environmental Compliance Audits	95
Analysis, Liquid Chromatography	81	Computer Devices	89	Environmental Engineering	95
Analysis, Soil, Water, Air	81	Computer Modeling (Air, Groundwater, Hazard & Risk)	89	Environmental Law	95
Analytical Instruments	82	Computer Software, Chemical Database	89	Environmental Site Assessment	95
Analytical Instruments, Air	82	Computer Software, Environmental Management	90	Environmental Test Chambers	95
Analytical Instruments, Hazardous Materials	82	Computer Software, Management (MSDS)	90	Equipment Rental	95
Analytical Instruments, Rentals	82	Computer Software, Management, Hazardous Waste	90	Evaporation Equipment	95
Analytical Instruments, Wastewater	82	Computer Software, Regulatory Compliance	90	Excavating Service	95
Analytical Instruments, Water	82	Computer Software, SARA Reporting	90	Expansion Joints	95
Analytical/Research Services	82	Computer Software, Training	90	Explosion Vents	96
Annunciators/Alarms	82	Concentrators	90	Fabric Filter	96
Aquifer Restoration	82	Conductivity Instrumentation	90		
Asbestos Abatement Services/Equipment	82	Consulting Services	90	F	PAGE
B	PAGE	Continuing Education	91	Fabricated Metal Products	96
Backflow Preventers	84	Contracting Services	91	Fan Repair/Rebuilding	96
Bacteria Enzymes	84	Controllers	91	Fans	96
Bacteriological Supplies	84	Conveyors	91	Feeders	96
Baffles/Booms	84	Cooling Tower Water	91	Feedwater Treatment Equipment	96
Baghouse Monitoring	84	Cooling Towers	91	Fiberglass Products	96
Baghouses	84	Core Sampler	91	Field Testing Instruments/Services	96
Balances	84	Corrosion Instrumentation/Protection	91	Filter Accessories	96
Balers	84	Corrosion Resistant Blower	92	Filter Presses	96
Barriers	84	Couplings	92	Filtration Systems	96
Batching/Blending Systems	84	Covers/Domes	92	Fire Safety Equipment	96
Bentonite	84	Crushers	92	Fittings	96
Bin Discharger	84	Cyclones	92	Flame Arrestors	96
Bin/Hoppers	84			Flash Point Tester	96
Bioassay	84	D	PAGE	Floating Baffles	96
Biological Testing Apparatus/Supplies	84	Dampers	92	Floats/Pontoons	96
Bioremediation	85	Data Acquisition Equipment	92	Flocculants	96
Blowers	85	Data Loggers	92	Flotation Equipment	97
BOD Test Equipment	85	Deaerators/Degasifiers	92	Flow Instrumentation	97
Boiler Feedwater Treatment Equipment	85	Debris Baskets	92	Flowmeters, Liquid, Gas & Steam	97
Boilers	85	Dechlorination Equipment	92	Flowmeters, Low Volume	97
Burners	85	Decontamination Equipment	92	Flowmeters, Mass	97
Bushings	85	Deep Well Systems	92	Flowmeters, Variable Area	97
C	PAGE	Defoaming/Degreasing Equipment	92	Flue Gas Conditioning	97
Calibration	85	Dehumidifiers	92	Flue Gas Desulfurization	97
Calorimeters	85	Deionizers	92	Flumes/Weirs	97
Carbon Adsorption	85	Demineralsizers	92	Flushing/Cleaning Equipment	97
Carbon Dioxide Detectors	86	Density Instrumentation	92	Fly Ash Recovery/Treatment Systems	97
Carbon Monoxide Detectors	86	Desalination Equipment	92	Freeze Protection	97
		Detectors	92	FTIR Spectrometers	97
				Fume Exhaust System	97

Fume Hoods	97
G	PAGE
Gas Chromatographs	97
Gas Cooling Equipment	97
Gas Detectors	97
Gas Source/Supplies	98
Gas Storage Equipment	98
Gaskets/Packing/Seals	98
Generators	98
Geographic Information Systems	98
Geophysical Instruments	98
Geotextiles	98
Glassware	98
Grit Handling Equipment	98
Groundwater Monitoring	98
Groundwater Reclamation	98
Groundwater Testing & Monitoring Equipment	98
Groundwater Treatment/Services	98
H	PAGE
Hazardous Material Handling	100
Hazardous Material/Waste	100
Hazardous Waste Containers	100
Hazardous Waste Equipment	100
Hazardous Waste Handling	100
Hazardous Waste/Mat Treatment, Storage, Disposal	100
Hazardous Waste Recycling	103
Hazardous Waste Services	103
Hazardous Waste Transportation	103
Hazmat Waste Dump & Roll-Off Trailers	103
Heat Exchangers	103
Heat Recovery Systems	103
Heating Cable/Tape	103
Heavy Metal Detectors	103
Hose/Tubing	103
Hot Air Steam Stripping	103
Horizontal Boring Guidance System	103
Humidity Instrumentation	103
Hydraulic Components Systems & Rebuilding Service	103
Hydrocarbon Detectors	103
Hydrogen Sulfide Control	104
Hydrogen Sulfide Detectors	104
Hydrological Equipment	104
I	PAGE
Identification Systems	104
Incineration Systems	104
Indoor Air Quality	104
Industrial Hygiene	104
In-line Mixers	104
Instrument Accessories	104
Instrument Rental	104
Insulation, Thermal	104
Insurance	104
Intake Screens	105
Intercoms	105
Ion Exchange	105
L	PAGE
Labeling	105
Laboratory Equipment/Supplies	105
Laboratory Services/Testing	105
Lagoon Separators/Baffles	105
Land Application Equipment	105
Land Application Systems	105
Land Assessment/Strip Chart Digitizers	105
Landfills	105
Landfills Equipment	105
Landfills Services	105
Leachate Treatment	105
Lead Paint Abatement	106
Leak Detectors	106
Level Instrumentation	106
Level, Sight Gauges	106
Lift Stations	106
Lime Slakers	106
Liners	106
Liquid Extractors	106
Locators, Pipe/Valve/Cable	106
M	PAGE
Make-up Air System	106
Management Services	106
Manometers	106
Material Safety Data Sheet Software	106
Medical Waste Disposal	106
Mercury Instruments	106
Mercury Spill Cleanup Products	106
Metal Fixation	106
Metal Recovery Systems	106
Meteorological	106
Meters	106
Microscopes	108
Mist Eliminators/Collectors	108
Mixers	108
Mobile Labs	108
Moisture Instrumentation	108
Monitoring Systems, Air	108
Monitoring Systems, Hazardous Material	108
Monitoring Systems, Water	108
Motor Controllers	109
Motors	109
N	PAGE
Nitrogen Oxide Detectors	109

Noise Dewatering Supplies	109
Noise/Sound Instruments	109
Nozzles	109
Nuclear Waste Handling Equipment	109
O	PAGE
Oceanographic Equipment	109
Odor Control Equipment	109
Odor Control Treatment	109
Oil Skimmers	109
Oil Spill Control Equipment/Services	109
Oil/Water Monitors	109
Oil/Water Separation	109
Opacity	110
Operation & Maintenance Services	110
ORP Instrumentation	110
Oxidizers	110
Oxygen Detectors	110
Oxygen/Ozone	110
Ozonators	110
Ozone Detectors	110
P	PAGE
Packaged Treatment Plants	111
Packing Materials	111
Parametric Emission Monitors	111
Particle Detectors	111
Particle Sizing Instruments	111
Passive Hydrocarbon Recovery System	111
PCB Replacement	111
PCB Testing	111
Permitting	111
Pest/Weed Control	111
pH Instrumentation	111
Phase Converters	111
Pilot Plants	111
Pipeline Cleaning, Repair	111
Piping, Dual Containment	111
Piping Equipment	111
Pollution Survey Equipment	111
Polymer Blending/Feeding Systems	112
Portable Computers	112
Pre-Fabricated Trenches & Sumps	112
Predictive Emission Monitors	112
Pressure Boosters	112
Pressure/Vacuum Instrumentation	112
Process Control Instrumentation	112
Professional & Trade Associations	112
Programmable Controllers/Timers	112
Protective Clothing	112
Publications	112
Pulverizers	112
Pump Controllers	112
Pumping Stations/Systems	112
Pumps (sludge, wastewater, groundwater, misc.)	112
Pyrolytic Processing	113
R	PAGE
Radiometer/Radiation Instrumentation	113
Radon, Testing & Analysis	113
Recorder Accessories	113
Recorders	113
Recycling Equipment/Services	113
Reference Material	113
Reflectometers	113
Refractometers	113
Refractory Materials	113
Regulators	113
Remediation	113
Remediation, Insitu	114
Remediation Services	114
Rental Services	114
Respirometers	115
Reverse Osmosis Equipment	115
Risk Analysis	115
Rupture Disks	116
S	PAGE
Safety Equipment & Products	116
Sample Containers	116
Sampling Direct Push	116
Sampling Systems	116
Screens	116
Scrubbers	116
Sealants	116
Secondary Containment	116
Sedimentation Equipment	116
Sensors	116
Separation Systems	118
Separators	118
Septic Tanks	118
Sequencing Batch Reactors	118
Settling Chambers	118
Sewage/Sludge Disposal Equipment/Services	118
Sewage Transport Systems	118
Sewage Treatment Equipment	118
Sewerage Systems, Vacuum	118
Sewer Inspection TV System	118
Shelters	118
Shredders	119
Signal Conditioners	119
Silencers/Mufflers	119
Site Assessment	119
Sludge Blanket Level	119

Sludge Concentrating Equipment	119
Sludge Dewatering/Disposal Service	119
Sludge Dewatering Equipment	119
Sludge Management	121
Sludge Solidification	121
Slurry Cut-off Walls	121
Soil Gas/Groundwater Surveys	121
Soil Sampling Equipment	121
Solvent Recovery Systems	121
Sonic Cleaning Devices	122
Speed Reducers	122
Spill Control Equipment/Products/Services	122
Spraying Equipment	122
Stack Emission Monitors	122
Stack Emission Testing	122
Stack Flow Meters	122
Standards	122
Stenizers	122
Stormwater Monitoring	122
Stormwater Treatment	122
Strainers	123
Sulfate/Sulfide Detectors	123
Sulfur Dioxide	123
Sulfur Oxide Detectors	123
Suspended Solids Instrumentation	123
Sweepers, Air Sweepers	123
Sweepers, In Plant Sweepers	123
Sweepers, Truck Mounted - In Plant	123
T	PAGE
Tank Linings	123
Tanks	123
TCLP	123
Telemetry Systems	123
Telescoping Valves	123
Temperature Instrumentation	123
Test Equipment, misc.	123
Test Kits/Services	123
TOC Detectors	123
Tools	123
Total Carbon Detectors	123
Total Nitrogen Analyzers	123
Total Oxygen Demand	124
Total Sulfur Detectors	124
Toxic Gas Detectors	124
Toxicological Services	124
Tracer Products	124
Training Environmental Science	124
Training Management Software	124
Training Personal Protective Equipment	124
Training Services/Equipment	124
Training Videos	124
Transmitters	124
Transport in Porous Media	124
Transportation	124
Traps	124
Trenchless Pipeline Rehabilitation	124
Trucks/Trailers	124
Turbidity Instrumentation	124
Turbidity Standards	124
U	PAGE
Ultrafiltration Equipment	124
Underground Storage Tank Equipment	124
Underground Tank Leak Monitors	124
V	PAGE
Vacuum Cleaning Equipment	125
Vacuum Loading Equipment	125
Vacuum, Critical Filter	125
Valve Actuators/Operators	125
Valve Positioners	125
Valve Replacement Parts	125
Valve Systems	125
Valves	125
Vapor Recovery	125
Variable Speed Drives	125
Ventilation Equipment	125
Vents	125
Vibration Instruments	125
Viscosity Instruments	125
VOC Removal Systems	125
W	PAGE
Waste Minimization	125
Wastewater Treatment Systems	126
Water Conditioning Equipment	126
Water Jetting Equipment	126
Water Meters	126
Water Purification Systems	126
Water Quality Instrumentation	126
Water/Wastewater Testing Chemicals	127
Water/Wastewater Treatment Equipment	127
Water/Wastewater Treatment Plants	127
Weather Monitoring	127
Weighing Equipment	127
Wetlands	127

Aboveground Storage Tanks

Aboveground Storage Tanks

Aero Tec Laboratories Inc
SEE AD ON PAGE 45

Air Plastics Inc
Alton Geoscience Inc
Aroco Power Utilized Fueler Inc
Assmann Corp of America
Baker Tanks Inc
Blhmyer Engineers Inc
Brown-Minneapolis Tank
Clean World Engineering Ltd
Columbian Steel Tank Co
ConSpan Bridge Systems
Concrete Systems Inc
Conti Environmental Inc
Convault Inc
Davis Process Div
Empac Corp
Environetics Inc
Environmental Products & Services Inc
Environmental Tank Systems Inc (ETS)

Exploration Products

SEE AD ON PAGE 71

Goad Co
Groundwater & Environmental Services Inc

Harding Lawson Associates

SEE AD ON PAGE 34

Highland Tank & Mfg Co
International Reserve Equipment Corp
Killam Associates
LWD Inc
Monarch Separators Inc
National Technical Information Service
Plastic Fusion Fabricators Inc
Plastonics Inc
Poly Processing Co
R E Wright Environmental Inc
Remediation Inc
Safe-T-Tank Corp
The Tapecoat Company
TRC Environmental Corp

SEE AD ON PAGE 32

Testwell Craig Laboratories Inc
U S Best
Vibra Screw Inc

Absorption Equipment

Safety Div
American Environmental Instruments Inc
American Technologies Group Inc
Andersen 2000 Inc
Atlantic Screen & Mfg
Bay Marketing
Carbon Activated
Celcolite Air Pollution Control
Croll Reynolds Co Inc
Ducon Environmental Systems Inc
Durr Environmental Systems
Environmental Products & Services Inc
Environmental Resource Center
General Carbon Corp
Met-Pro Corp Systems Div
Misorix Inc
New Pig Corp
SEE AD ON PAGE 49, 99
R E Wright Environmental Inc
RJ Environmental Inc
Remediation Service Intl
Slikwik Sorbents
Stanley Storage Systems
3M Occupational Health & Environmental
U S Environmental Engineering Inc

Access Covers



Haliday Products Inc

Acid Rain Gauge

Global Water
Scientific Sales Inc

Acoustical Chambers

BRD Noise & Vibration Control Inc
United Process Inc

Activated Carbon

AAF Intl
Alton Geoscience Inc
Applied Membranes Inc



BARNEBEY & SUTCLIFFE CORPORATION
800-886-2272

Barnebey & Sutcliffe Corp
Calgon Carbon Corp
Cameron Environmental Inc
Cameron-Yakima Inc
Carbon Activated
Carbonair Environmental Systems Inc
Carbrol Corp
College Research Corp (CORECO)
Colloid Environmental Technologies Co



313-459-6800

Durr Environmental Systems
Environmental Products & Services Inc
Environmental Restoration Systems
Environmental Systems Engineering Inc



412-741-2030

EnviroTrol Inc
General Carbon Corp
GeoPure Systems & Services
HEMCO Corp
Highland Tank & Mfg Co
JBI Spray Booths & Finishing Systems
Micro Air Air Cleaners by Metal-Fab Inc
NUCON Intl Inc
Northwestern Carbon
Otr Control Co Inc
Pittsburgh Activated Carbon Services Inc
OED Environmental Systems Inc
Serfilco Lts
Smith & Loveless Inc



407-567-1320

Vara Intl Div of Calgon Carbon Corp
Water Equipment Technologies Inc
Western Filter Co
Wheelabrator Clean Air Systems Inc
Wheelabrator Technologies Inc

Actuators

Asahi/America Inc
Boston Gear
Chemtrol Div of Nibco Inc
Ducon Environmental Systems Inc
Durrion Co Inc
Dwyer Instruments Inc
Limiterque
Parker Hannifin Corp
Plast-O-Matic Valves Inc

Adsorbent Equipment

American Sty & Abatement Products Inc
Barnebey & Sutcliffe Corp
Bay Marketing
Calgon Carbon Corp
ChromatoChem Inc
Containment Systems
Croll Reynolds Co Inc
D G Supplies Inc
Dival Safety Equipment
Dual Div Met-Pro Corp
Ducon Environmental Systems Inc
Durr Environmental Systems
Dustvent Inc
Environmental Products & Services Inc
Environmental Systems Engineering Inc



412-741-2030

EnviroTrol Inc
Highland Tank & Mfg Co
Innovative Concepts Program
NUCON Intl Inc
New Pig Corp
SEE AD ON PAGE 49, 99
Northwestern Carbon

Paragon Environmental Systems Inc
RJ Environmental Inc
Smith & Loveless Inc
3M Occupational Health & Environmental Safety Div
U S Environmental Engineering Inc
Wheelabrator Clean Air Systems Inc
Wheelabrator Technologies Inc

Aeration Systems

Aeration Industries Intl Inc
Aeromix Systems Inc
Bioscience Inc
Carbrol Corp
Davco Div Davis Water & Waste Industries Inc
Deep Shaft Technology Inc
Envirex Inc



513-388-4100

EnviroQuip International Inc
Environmental Systems Engineering Inc
Export Technologies Inc



713-699-0152

Flo Trend Systems Inc

SEE AD ON PAGE 64, 91

Franco Environmental Technologies
Hydro Group Inc
Johnson & Associates Consulting
Lamson Corp
Mazzei Injector Corp
Pego Systems Inc
Purestream Inc
RGF Environmental Systems Inc
Remediation Service Intl
Smith & Loveless Inc
Spencer Turbine Co, The
Suburbia Systems Corp
U S Environmental Engineering Inc

Aerators/Diffusers

Aeration Industries Intl Inc
Aeromix Systems Inc
Carbrol Corp
Davco Div Davis Water & Waste Industries Inc
EIMCO Process Equipment
Envirex Inc
EnviroQuip International Inc
Environmental Restoration Systems
Environmental Systems Engineering Inc
Export Technologies Inc
Franco Environmental Technologies
Hydro Group Inc
Johnson & Associates Consulting
Pego Systems Inc
Purestream Inc
Smith & Loveless Inc
Spencer Turbine Co, The
Zimpro Environmental Inc

Aerosol Detectors

Argus Environmental Monitoring
BGI Inc
Gillan Instruments
NUCON Intl Inc
Sensidyne Inc

Aerosol/Particle/Smoke Generators

BGI Inc
NUCON Intl Inc
Sensidyne Inc

Agglomerators/Briquetters/Pelletizers

APV Anhydro-Separation Technologies
Universal Process Equipment Inc

Agitators

Aeration Industries Intl Inc
Associated Design & Manufacturing Co
Cheminer Inc
DBS Manufacturing Inc
EMI Inc

Flo Trend Systems Inc

SEE AD ON PAGE 64, 91

International Reserve Equipment Corp
Liquid Waste Technology
SEE AD ON PAGE 65
Pego Systems Inc
U S Best
Universal Process Equipment Inc
Warman Intl Inc

Air Analyzers

Advanced Containment Systems Inc
Advanced Pollution Instrumentation Inc
Air Instruments & Measurements Inc
American Environmental Instruments Inc
Anarad Inc
Argus Environmental Monitoring
Arizona Instrument Corp
Bacharach Inc
Baldwin Environmental Inc
Bovar Environmental
Bruehl & Kjaer Instruments Inc
Buck Scientific Inc
Burns & McDonnell Waste Con. Inc
CEA Instruments Inc
Clean Air Engineering
Coastal Environmental Systems
Columbia Scientific
Control Instruments Corp
Durr Environmental Systems
Dyna-FID Inc
EMS Environmental Monitor Service
Ecom America
Energy Efficiency Systems Inc
Entech Instruments Inc
Environics Inc
Environmental Products & Services Inc
Environmental Systems Corp
Enviroplan Inc
Fluid Components Intl
Goyen Valve Corp
Graseby



800-321-0322

Foxboro Co, The
Graseby

SEE AD ON PAGE 15, 89

HNU Systems Inc
Horiba Instruments Inc
ICF Kaiser International Inc
Intek Corp/Rent-Alyzer
International Sensor Technology
John Zink Co Div Koch Engineering Co
KVA/Analect
Lamb Combustion
MKS Instruments Inc



608-825-2055

Omega Engineering Inc

SEE AD ON PAGE 2

Photovac Monitoring Instruments

SEE AD ON PAGE 51, 57

RKI Instruments Inc
Rosemount Analytical Inc
SCI-TEC Instruments Inc
SRI Instruments
Scott Lawson Group Inc, The
Sensidyne Inc
Shimadzu Scientific Instruments Inc
Siemens Energy & Automation Inc
Sierra Monitor Corp
Tekmar Co
Terra Universal Inc
Transducer Research Inc
Wedding & Associates Inc
Zellweger Analytics Inc

Air Classifiers

ABB Air Preheater Inc RaymondProds
General Kinematics Corp
Universal Process Equipment Inc

Air Dispersion Services



505-266-6611

Environmental Services Inc

Air Emission Monitoring Equipment

Advanced Control Systems Corp
Advanced Pollution Instrumentation Inc
Advanced Sensor Devices Inc
Air Instruments & Measurements Inc

American Environmental Instruments Inc
Ametek Inc Process & Analytical Instruments Div
Anarad Inc
Argus Environmental Monitoring



800-255-5008

Auburn International Inc

SEE AD ON PAGE 69

Bacharach Inc
Bailey Controls Co
Baldwin Environmental Inc
Bovar Environmental
Brady USA Inc Sigmarr Div
Bruehl & Kjaer Instruments Inc
Buck Scientific Inc
Burns & McDonnell Waste Con. Inc
CEA Instruments Inc
Clean Air Engineering
Coastal Environmental Systems
Columbia Scientific
Control Instruments Corp
Durr Environmental Systems
Dyna-FID Inc
EMS Environmental Monitor Service
Ecom America
Energy Efficiency Systems Inc
Entech Instruments Inc
Environics Inc
Environmental Products & Services Inc
Environmental Systems Corp
Enviroplan Inc
Fluid Components Intl
Goyen Valve Corp
Graseby

SEE AD ON PAGE 15, 89

HNU Systems Inc
Horiba Instruments Inc
ICF Kaiser International Inc
Intek Corp/Rent-Alyzer
International Sensor Technology
John Zink Co Div Koch Engineering Co
KVA/Analect
Lamb Combustion
MKS Instruments Inc

MSI/Mechanical Systems Inc
Marine Shale Processors Inc
Mast/Keystone Inc
McNeill Intl
Met One Instruments Inc
SEE AD ON PAGE 43, 85
Midwest Laboratories Inc
Milco Safety Rental
Monitor Labs Inc
National Technical Information Service
OI Analytical

Omega Engineering Inc

SEE AD ON PAGE 2

Perkin-Elmer Corp Photovac Monitoring Instruments

SEE AD ON PAGE 51, 57

Restek Corp
Rosemount Analytical Inc
SCI-TEC Instruments Inc
SRI Instruments
Sensidyne Inc
Sentex Systems Inc
Servomex Co Inc
Siemens Energy & Automation Inc
Sierra Monitor Corp
Technical Heaters Inc
Tekmar Co
Terra Universal Inc
Testo Inc

SEE AD ON PAGE 72

Tracker Technologies Inc
U S Industrial Products Co Inc
United Sciences Inc
Wheelabrator Clean Air Systems Inc
Wheelabrator Technologies Inc

Air Emissions Testing

AirNova Inc
American Environmental Instruments Inc
August Mack Environmental Inc
Bacharach Inc
Blasland Bouck & Lee Inc
Bovar Environmental
Braun Intertec Corp

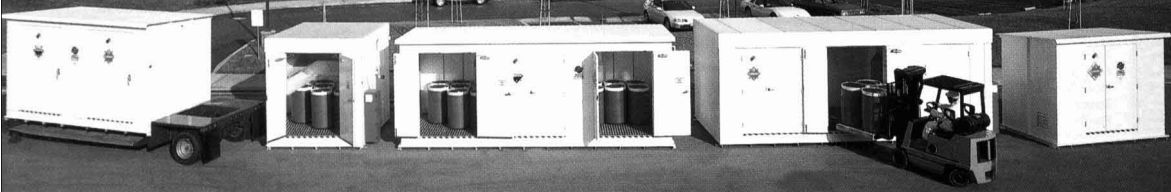

The preferred choice.

Proven hazmat safety at thousands of locations worldwide...



Hazmat storage professionals around the world have found that they can trust us to deliver a quality product and responsive customer support. They know that our broad standard and engineered product

line will give them the flexibility to meet their specific

hazardous materials storage, handling, and dispensing needs. They know that when you specify Safety Storage, you get more than just a hazmat building.

First, you get a safe, convenient way to deal with your hazardous materials, reducing your risk and liability. You can be assured of full compliance with all federal, state, and local environmental regulations.

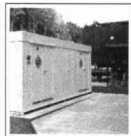

Then, you get our more than 12 years of experience in designing and manufacturing hazmat buildings and lockers, more experience than anyone else in the industry. You get our wide range of engineering

and compliance know how. You get quality and cost benefits accruing from our more than 250,000 square feet of manu-



California



Indiana



Mexico

facturing space in three different plants.

Unexpected hazmat clean-up costs and fines can be staggering—they can shut you down and put you permanently out of business.

Our number one objective is to provide you with a cost-effective way to reduce your hazardous materials risk and liability. Safety Storage is the confident choice—



the hazmat buildings and lockers that are trusted by the Fortune 2000 and the U.S. Government. Whether your need is simply for storage or for a dedicated hazmat building engineered and built to safely isolate and contain a potentially volatile process, Safety Storage is the safe buy. Your best buy.



Call us today for complete details.



Every Safety Storage building is built with quality materials and components, and inspected at every step in the production process. Selected models are Factory Mutual System (FM) approved or pending, Underwriters Laboratories (UL) classified, and state certified.



SAFETY STORAGE™

Circle 80 on card.

...professional hazmat solutions!

1-800-344-6539

SAFETY STORAGE, INC.

2301 Bert Drive

Hollister, CA 95023

Phone: 408-637-5955

Fax: 408-637-7405

Air Emissions Testing

Buck Scientific Inc
 CDM Federal Programs Corp
 CTL Environmental Services
 Camp Dresser & McKee Inc
 Chester Environmental
 Clean Air Engineering
 Clean World Engineering Ltd
 Cura Inc
 Dames & Moore
 Delta Environmental Consultants Inc
 Durr Environmental Systems
 ENSR
 ERM Group Inc
 Eroncon Services Inc
 Energy Efficiency Systems Inc
 Entech Instruments Inc
 Entropy Inc
 Environex Inc
 Environmental Products & Services Inc
 Environmental Science & Engineering Inc
 Geraghty & Miller Inc
 Heidi Mj Co
 Hazclean Environmental Consultants Inc
 Horiba Instruments Inc
 ICF Kaiser International Inc
 Inchcape Testing Services/Environmental
 Laboratories

K & B Design Inc
 Killam Associates
 MMT Environmental Services Inc
 Mabbett & Associates Inc



Melco Environmental
 Midwest Laboratories Inc
 National Technical Information Service
 Northern Lake Service Inc
 Pace Inc

Pacific Environmental Services Inc
 SEE AD ON PAGE 56, 88

Performance Analytical Inc
 Perkin-Elmer Corp
 R E Wright Environmental Inc
 RAMCON Environmental Corp
 RMT Inc
 Raytheon Environmental Svcs/
 Raytheon Engineers & Construction
 Recon Environmental Corp
 Rollins Environmental Services
 Ross Analytical Services Inc
 Roy F Weston Inc
 Scott Specialty Gases
 Sentex Systems Inc
TRC Environmental Corp
 SEE AD ON PAGE 32
 Traverse Group, The
 United Sciences Inc

Air Exhaust Noise Control

Dustvent Inc
 Environments Inc
 Pego Systems Inc
 Raytheon Environmental Svcs/
 Raytheon Engineers & Construction
 Terra Universal Inc
 United McGill Corp

Air Filters

AAF Intl

Ameri-can Engineering
 Baldwin Environmental Inc
 Barnebey & Sutcliffe Corp
 Calgon Carbon Corp
 Cameron Environmental Inc
 Cameron-Yakima Inc
 Chemco Manufacturing Co Inc
 Dellech Engineering Inc
 Ducon Environmental Systems Inc
 Durr Environmental Systems
 Dustvent Inc
 General Carbon Corp
 Industrial Filter & Pump Mfg Co
 JBI Spray Booths & Finishing Systems
 Keystone Filter Div Met-Pro Corp
 La-Man Corp
 Mac Environmental
 Micro Air Air Cleaners by Metal-Fab Inc



Monsanto Enviro-Chem Systems Inc
 NUCON Intl Inc
 Neolentk Health Technologies Inc
 Parker Hannifin Corp
 Pego Systems Inc
 Schuller International Inc
 Terra Universal Inc
 3M Filtration Products
 Whatman Inc
 Whatman/Balston

Air Make-up Units

Hartzell Fan Inc
 JBI Spray Booths & Finishing Systems
 NUCON Intl Inc
 Seagull Technical Services

Air Pollution Control Equipment

AAF Intl
ABB Air Preheater Inc
 SEE AD ON PAGE 81
 Advanced Air Technology Inc
 Advanced Data Systems
 Adwest Technologies Inc
 Air Plastics Inc
 Air Quality Engineering Inc
 Airex Corp
 Ambient Engineering Inc
 American Gas Products Inc
 Anarad Inc
 Andersen 2000 Inc
 Anguil Environmental Svcs Inc
 Applied Utility Systems Inc
 August Mack Environmental Inc
 Bailey Controls Co
 Baldwin Environmental Inc



Barnebey & Sutcliffe Corp
 Bovar Environmental
 Buck Scientific Inc
 CEA Instruments Inc
 CVM Corp
 CVT America LLC
 Calgon Carbon Corp
 Cameron Environmental Inc
 Carbtrol Corp
 Celcote Air Pollution Control
 Clean Air Engineering
 Coastal Environmental Systems
 College Research Corp (CORECO)
 Croll Reynolds Co Inc
 Dasibi Environmental Corp
 DeMarco MAX VAC Corp
 Deder Corp
 Degussa Stationary Emission Control
 Catalyst
 Duall Div Met-Pro Corp
 Ducon Environmental Systems Inc



Durr Environmental Systems
 Dustvent Inc
 Dwyer Instruments Inc
 EPG Companies
 Ecom America
 Edwards Engineering Corp
 Electrosynthesis Co Inc
 Energy Efficiency Systems Inc
 Entech Instruments Inc
 Environex Inc
 Environments Inc
 Enviroplan Inc
 Epon Industrial Systems Inc
 General Carbon Corp
 Global Technologies
 Goad Co
 Goal Line Environmental Technologies
 Grace Tec Systems
 Griffin Environmental Co Inc
 HNU Systems Inc
Harding Lawson Associates
 SEE AD ON PAGE 34
 Horiba Instruments Inc
 ICF Kaiser International Inc

International Sensor Technology
 JBI Spray Booths & Finishing Systems
 John Zink Co Div Koch Engineering Co
 Johnson Matthey
 Justrite Manufacturing
 MMT Environmental Services Inc
 Mac Environmental



Martin Marietta Magnesia Specialties Inc
 McNeill Intl
 Membrane Technology & Research Inc
 Met-Pro Corp Systems Div
 Micro Air Air Cleaners by Metal-Fab Inc



Misonix Inc



Monsanto Enviro-Chem Systems Inc
 Nalco Fuel Tech
 National Technical Information Service
 Nelderman Inc
 Norton Chemical Process Products Corp
 Ozaic Inc

Omega Engineering Inc

SEE AD ON PAGE 2
 Paragon Environmental Systems Inc
 Pego Systems Inc
 Precision Environmental International Inc
 Process Combustion Corp
 RJ Environmental Inc
 RMT Inc
 Remedial Systems Inc
 Remediation Service Intl
 Remtech Inc
 Rusmar Inc
 Seghers Dinamec Inc
 Sentex Systems Inc
 Spraying Systems Co
 Therm Tech Inc
 Thermoton
 United Air Specialists Inc
 United McGill Corp
 United Sciences Inc
 W Canning Inc
 Weatherly Inc
 Westport Environmental Systems
 Wheelabrator Clean Air Systems Inc
 Wheelabrator Technologies Inc
 Winsor & Jerauld



Wolverine (Massachusetts) Corp
 Xchanger Inc
 Zurn Air Systems

Air Quality Instrumentation

Advanced Data Systems
 Advanced Pollution Instrumentation Inc
 Air Instruments & Measurements Inc
 Air Resource Specialists Inc
 Airmetrics
 American Environmental Instruments Inc
 Anarad Inc
 Arizona Instrument Corp
 BGI Inc
 Bacharach Inc
 Baldwin Environmental Inc
 Bruel & Kjaer Instruments Inc
 Buck Scientific Inc
 CDS Analytical Inc
 CEA Instruments Inc
 Campbell Scientific Inc
 Clean Air Engineering
 Coastal Environmental Systems
 Columbia Scientific
 Dames & Moore
 Dasibi Environmental Corp
 Dyna-FID Inc
 Energy Efficiency Systems Inc
 Enmet Corp
 Environments Inc

Enviroplan Inc
 Foxboro Co, The
Graseby

SEE AD ON PAGE 15, 89

Handar
 Hazzo Services Inc
 Horiba Instruments Inc
 Industrial Scientific Corp
 Intek Corp/Rent-Alyzer
 Interscan Corp
 KVA/Analect
 Logic Beach Inc
 McNeill Intl



Met One Instruments Inc

SEE AD ON PAGE 43, 85

Metroconics Inc
 Midwest Laboratories Inc
 Mi-Ram Technology Inc
 Mico Safety Rental
 Monitor Labs Inc
 Novalytix Corp
 OI Analytical
Omega Engineering Inc
 SEE AD ON PAGE 2
 Perkin-Elmer Corp
Photovac Monitoring Instruments
 SEE AD ON PAGE 51, 57
 R E Wright Environmental Inc
 R M Young Co
 RKI Instruments Inc
 Remtech Inc
 Roy F Weston Inc
 SCI-TEC Instruments Inc
 SRI Instruments
 Scott Lawson Group Inc, The
 Sensidyne Inc
 Siemens Energy & Automation Inc
 Sierra Monitor Corp
 Solomat - Neotronics
 Spectrex Corp
 Tekmar Co
 Transducer Research Inc
 U S Industrial Products Co Inc
 Wedding & Associates Inc

Air Quality Permits



Environmental Services Inc

Air Samplers

A P Buck Inc
 Air Dimensions Inc
 Air-Scan Environmental Technologies Inc
 Airmetrics
 Allego Industries
 American Environmental Instruments Inc
 American City & Abatement Products Inc
 Aramco
 Argus Environmental Monitoring
 Arizona Instrument Corp
 Assay Technology Inc
 Associated Design & Manufacturing Co
 BGI Inc
 BIOS Intl Inc
 Baldwin Environmental Inc
 CEA Instruments Inc
 Clean Air Engineering
 Entech Instruments Inc
 Environmental Products & Services Inc
 FMI Fluid Metering Inc
 G O Environmental Inc
 Gas Tech Inc
 Gillan Instruments
Graseby

SEE AD ON PAGE 15, 89

Hazzo Services Inc
 Intek Corp/Rent-Alyzer
 MKS Instruments Inc
 Mast/Keystone Inc
 McNeill Intl
 Meriter
 Metroconics Inc
 National Draeger Inc
 Nuclear Associates
 Oilind Safety

Anaerobic Pretreatment

Omega Engineering Inc

SEE AD ON PAGE 2

Restek Corp
 SKC Inc
 Scott Lawson Group Inc, The
 Sensidyne Inc
 Sierra Monitor Corp



Spectrex Corp
 Staplex Air Sampler Div
 Technical Heaters Inc
 Terra Universal Inc
 3M Occupational Health & Environmental
 Safety Div
 Valien Safety Supply Co
 Wedding & Associates Inc
 Wonder Makers Inc

Air Strippers

Advanced Air Technology Inc
 Aeromix Systems Inc
 Air Plastics Inc
 Alligator Inc
 Andersen 2000 Inc
 Carbonair International Systems Inc
 Carbtrol Corp
 Davis Process Div
 Delta Cooling Towers Inc
 Dival Safety Equipment
 Duall Div Met-Pro Corp
 Environmental Products & Services Inc
 Environmental Restoration Systems Inc
 Environmental Tank Systems Inc (ETS)
 GeoPure Systems & Services
 Geotech Environmental Equipment Inc
 Hydro Group Inc
Integrated Environmental Solutions Inc
 SEE AD ON PAGE 35, 87
 Jaeger Products Inc



LI P Strippers
 Mazzei Injector Corp
 North East Environmental Products Inc
 ORS Environmental Systems
 Paragon Environmental Systems Inc
 Plastronics Inc
 QED Environmental Systems Inc
 Remedial Systems Inc
 U S Environmental Engineering Inc
 Unipure Environmental
 Wheelabrator Clean Air Systems Inc

Air Velocity Meter

Aramco
 Argus Environmental Monitoring
 Dwyer Instruments Inc
 Epic Inc
 Entech Instruments
 Hazzo Services Inc
 Intek Corp/Rent-Alyzer
 Kewaunee Scientific Corp
 Oilind Safety
Omega Engineering Inc
 SEE AD ON PAGE 2
 Peak Measurement
 Scientific Sales Inc
 Scott Lawson Group Inc, The
 Solomat - Neotronics
 Terra Universal Inc
Testo Inc
 SEE AD ON PAGE 72
 Valien Safety Supply Co

Alloys

Duriron Co Inc

Anaerobic Pretreatment

Bioscience Inc
 Export Technologies Inc
 Foth & Van Dyke
 ProBios Inc
 Seghers Dinamec Inc
 Smith & Loveless Inc
 Sverdrup Civic Inc
 U S Environmental Engineering Inc
 W Canning Inc

Analysis, Atomic Absorption

Analysis, Atomic Absorption

American Standards Testing Bureau Inc
Aqua Tech Environmental Laboratories Inc (ATEL)
Buck Scientific Inc
CTL Environmental Services
Con-Test/ATC Environmental Inc
EAS Laboratories
Eckenfelder Inc
EnsoTech Inc
Environmental Laboratory Services
Environmental Products & Services Inc
HES Inc
Heritage Environmental Services Inc
Micro Analytical Laboratories Inc
Midwest Laboratories Inc
Northern Lake Service Inc
Pace Inc
Peoria Disposal Co
Recon Environmental Corp
Rollins Environmental Services
Ross Analytical Services Inc
Roy F Weston Inc
SERCOLABORATORIES
SRI Instruments
Safety-Kleen Corp
Scott Lawson Group Inc, The
Sensidyne Inc
Sentex Systems Inc
Shimadzu Scientific Instruments Corp
TRC Environmental Corp
SEE AD ON PAGE 32
Testwell Craig Laboratories Inc
Tracer Research Corp
SEE AD ON PAGE 41
Triangle Laboratories Inc

Analysis, Electron Microscopy



AGX Inc
American Standards Testing Bureau Inc
Braun Intertec Corp
CTL Environmental Services
Con-Test/ATC Environmental Inc
Hygeia Environmental Laboratories Inc
Micro Analytical Laboratories Inc
Pace Inc
Rollins Environmental Services
Roy F Weston Inc
Structure Probe Inc/SPI Supplies
Testwell Craig Laboratories Inc
Triangle Laboratories Inc

Analysis, Gas Chromatography

AGA Gas Inc
Air Toxics Ltd
American Environmental Instruments Inc
American Standards Testing Bureau Inc
Aqua Tech Environmental Laboratories Inc (ATEL)
Argus Environmental Monitoring
Assay Technology Inc
Braun Intertec Corp
Buck Scientific Inc
CTL Environmental Services
Camp Dresser & McKee Inc
Clean Air Engineering
Con-Test/ATC Environmental Inc
Del Mar Scientific Inc
E S Industries
EAS Laboratories
ERM Group Inc
Earth Remediation Services Inc
Eckenfelder Inc
EnsoTech Inc
Environmental Laboratory Services
Environmental Products & Services Inc
Environmetrics



Foxboro Co. The
Graseby
SEE AD ON PAGE 15, 89

HES Inc
Haley & Aldrich Inc
Heritage Environmental Services Inc
Holzmacher McLendon & Murrell PC
Ionics Inc
L J Brouman & Assoc Ltd
Midwest Laboratories Inc
Northern Lake Service Inc
Pace Inc
Peoria Disposal Co

Performance Analytical Inc Photovac Monitoring Instruments

SEE AD ON PAGE 51, 57
Raytheon Environmental Svcs/
Raytheon Engineers & Construction
Recon Environmental Corp
Restek Corp
Rollins Environmental Services
Ross Analytical Services Inc
Roy F Weston Inc
SERCOLABORATORIES
SRI Instruments
Safety-Kleen Corp
Scott Lawson Group Inc, The
Sensidyne Inc
Sentex Systems Inc
Shimadzu Scientific Instruments Corp
TRC Environmental Corp
SEE AD ON PAGE 32
Testwell Craig Laboratories Inc
Tracer Research Corp
SEE AD ON PAGE 41
Triangle Laboratories Inc

Analysis, Gas Chromatography/ Mass Spectrometry

AGA Gas Inc
Air Toxics Ltd
American Standards Testing Bureau Inc
Aqua Tech Environmental Laboratories Inc (ATEL)
Braun Intertec Corp
CTL Environmental Services
Camp Dresser & McKee Inc
Con-Test/ATC Environmental Inc
EAS Laboratories
Eckenfelder Inc
EnsoTech Inc
Environmental Laboratory Services
Environmental Products & Services Inc
Environmetrics
HES Inc
Heritage Environmental Services Inc
Holzmacher McLendon & Murrell PC
L J Brouman & Assoc Ltd
Midwest Laboratories Inc
Nicolet Instrument Corp
Northern Lake Service Inc
Pace Inc
Peoria Disposal Co
Performance Analytical Inc
Raytheon Environmental Svcs/
Raytheon Engineers & Construction
Recon Environmental Corp
Restek Corp
Rollins Environmental Services
Ross Analytical Services Inc
Roy F Weston Inc
SERCOLABORATORIES
Safety-Kleen Corp
Shimadzu Scientific Instruments Inc
Testwell Craig Laboratories Inc

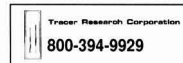

Tracer Research Corp
SEE AD ON PAGE 41
Triangle Laboratories Inc

Analysis, Liquid Chromatography

Air Toxics Ltd
American Standards Testing Bureau Inc
Aqua Tech Environmental Laboratories Inc (ATEL)
Assay Technology Inc
CTL Environmental Services
Camp Dresser & McKee Inc
ChromatoChem Inc
E S Industries
EAS Laboratories
Environmetrics
HES Inc
Holzmacher McLendon & Murrell PC
Jaeger Products Inc
L J Brouman & Assoc Ltd
Midwest Laboratories Inc
Northern Lake Service Inc
Pace Inc
Peoria Disposal Co
Performance Analytical Inc
Raytheon Environmental Svcs/
Raytheon Engineers & Construction
Recon Environmental Corp

Restek Corp
Rollins Environmental Services
Ross Analytical Services Inc
Roy F Weston Inc
Shimadzu Scientific Instruments Inc
Triangle Laboratories Inc

Analysis, Soil, Water, Air



AGX Inc
Adirondack Environmental Associates Inc
Air Source Technologies Inc
Air Toxics Ltd
Allied Environmental Consultants Inc
American Environmental Instruments Inc
American City & Abatement Products Inc
American Standards Testing Bureau Inc
Aqua Tech Environmental Laboratories Inc (ATEL)
Argus Environmental Monitoring
August Mack Environmental Inc

BioNebraska Inc
BioVir Laboratories Inc
Bioscience Inc
Bovar Environmental
Braun Intertec Corp
Buck Scientific Inc
CDM Federal Programs Corp
CTL Environmental Services



Camp Dresser & McKee Inc
Capital Controls Co Inc
Clean Air Engineering
Clean World Engineering Ltd
Con-Test/ATC Environmental Inc
Cura Inc
Degussa Stationary Emission Control Catalyst
Diversified Well Products Inc
EAS Laboratories
ERM Group Inc
Eckenfelder Inc

Analysis, Soil, Water, Air

EnsoTech Inc
Entech Instruments Inc
Environmental Laboratory Services
Environmental Products & Services Inc
Environmental Resource Center
Environmetrics
Foth & Van Dyke



Foxboro Co. The
HES Inc
Hazelclean Environmental Consultants Inc
Holzmacher McLendon & Murrell PC
Horiba Instruments Inc
Instrumentation Northwest Inc (INW)
Micro Analytical Laboratories Inc
Midwest Laboratories Inc
National Technical Information Service
Northern Lake Service Inc
Omega Engineering Inc
SEE AD ON PAGE 2
Pace Inc

PRODUCTS/SERVICES

OXIDIZER SYSTEMS

The solution to your pollution!

- ▲ Combu-Changer® Regenerative Oxidizer
- ▲ Cor-Pak® Thermal & Catalytic Oxidizers
- ▲ 99% VOC destruction
- ▲ 95% heat recovery
- ▲ ABB Air Preheater, Inc. - a world leader in VOC Control equipment
- ▲ 1100 installations worldwide since 1958
- ▲ An ISO 9001 certified company

ABB Air Preheater, Inc.

P.O. Box 372, Wellsville, NY 14895
Phone (716) 593-2700
Fax: (716) 593-2721

Peoria Disposal Co
Performance Analytical Inc
Photovac Monitoring Instruments
SEE AD ON PAGE 51, 57
Pittsburgh Activated Carbon Services Inc
Pollution Research & Technology Inc (PRT)
R E Wright Environmental Inc
Raytheon Environmental Svcs/
Raytheon Engineers & Construction
Recon Environmental Corp
Rollins Environmental Services
Ross Analytical Services Inc
Roy F Weston Inc
SERC0 Laboratories
SRI Instruments
Scott Lawson Group Inc, The
Sensidyne Inc
Sentex Systems Inc
Sewall, James W
Sharp & Associates Inc
Shimadzu Scientific Instruments Inc
Soil Solutions Inc
Structure Probe Inc/SPI Supplies
Tekmar Co
Teledyne Brown Engineering - Environmental Services
Testwell Craig Laboratories Inc
Tracer Research Corp
SEE AD ON PAGE 41
Transducer Research Inc
Traverse Group, The
Triangle Laboratories Inc
Zellweger Analytics Inc

Analytical Instruments
Air Instruments & Measurements Inc
American Environmental Instruments Inc
American Sty & Abatement Products Inc
Ametek Process & Analytical Instruments Div
Anarad Inc
Arthur Technology Inc
BTG Div of Spectris Technologies Inc
Bacharach Inc
Bio-Tek Instruments
Brinkmann Instruments Inc
Buck Scientific Inc
CDS Analytical Inc
CEA Instruments Inc
CEM Corp



913-681-3913

Challenge Environmental Systems Inc
Columbia Scientific
Del Mar Scientific Inc
Diversified Well Products Inc
Dyna-FID Inc
E S Industries
Ecom America
Entech Instruments Inc
Environics Inc
George Fischer Inc
Grassley Specac Inc
Great Lakes Instruments
HNU Systems Inc



800-227-4224

Hach Co
Handar
Hazzo Services Inc
Helima Cells Inc
Horiba Instruments Inc
Intek Corp/Rent-Alyzer
Ionics Inc
Johnson Yokogawa Corp
KVA/Analect
Leeman Labs Inc
MKS Instruments Inc
Mettler-Toledo Process Analytical Inc
Microbics Corp
Monitek Technologies Inc
Monitor Labs Inc
National Instruments



608-276-6100

Nicolet Instrument Corp
Novalyx Corp
OI Analytical

Omega Engineering Inc
SEE AD ON PAGE 2
Orbeco Analytical Systems Inc
Perkin-Elmer Corp
Rosemount Analytical Inc
Royce Instrument Corp
SRI Instruments
Schneider Instrument Co
Sensor Electronics Corp
Servomex Co Inc
Shimadzu Scientific Instruments Inc
Siemens Energy & Automation Inc
Spectrex Corp
Structure Probe Inc/SPI Supplies
Teledyne Brown Engineering
Analytical Instruments
Testo Inc
SEE AD ON PAGE 72
Zellweger Analytics Inc

Analytical Instruments, Air
A P Buck Inc
Advanced Pollution Instrumentation Inc
Air Instruments & Measurements Inc
Anarad Inc
Applied Technologies Inc
Argus Environmental Monitoring
Arizona Instrument Corp
Bacharach Inc
Baldwin Environmental Inc
Bruehl & Kjaer Instruments Inc
Buck Scientific Inc
CEA Instruments Inc
California Analytical Instruments Inc
Campbell Scientific Inc
Clean Air Engineering
Coastal Environmental Systems
Columbia Scientific
Control Instruments Corp
Datsic Environmental Corp
Dyna-FID Inc
E S Industries
Energy Efficiency Systems Inc
Emmet Corp
Entech Instruments Inc
Environics Inc



800-321-0322

Foxboro Co, The
Grassley
SEE AD ON PAGE 15, 89
HNU Systems Inc
Handar
Hazzo Services Inc
Horiba Instruments Inc
Inficon Inc
SEE AD ON PAGE 117
Intek Corp/Rent-Alyzer
KVA/Analect
MKS Instruments Inc
Mast/Keystone Inc
McNeill Intl
Monitor Labs Inc



608-276-6100

Nicolet Instrument Corp
Novalyx Corp
OI Analytical
Omega Engineering Inc
SEE AD ON PAGE 2
Perkin-Elmer Corp
Photovac Monitoring Instruments
SEE AD ON PAGE 51, 57
RKI Instruments Inc
Rosemount Analytical Inc
SRI Instruments
Scott Lawson Group Inc, The
Sensidyne Inc
Sentex Systems Inc
Servomex Co Inc
Shimadzu Scientific Instruments Inc
Siemens Energy & Automation Inc
Sierra Monitor Corp
Summit Analyzers
Tekmar Co
Testo Inc
SEE AD ON PAGE 72
Transducer Research Inc

VICI Metronics Inc
Wonder Makers Inc
Analytical Instruments, Hazardous Materials
American Environmental Instruments Inc
Bacharach Inc
Bio-Tek Instruments
CEA Instruments Inc
Diversified Well Products Inc



800-321-0322

Foxboro Co, The
HNU Systems Inc
Intek Corp/Rent-Alyzer
Ionics Inc
Myriad Industries
Oilind Safety
Perkin-Elmer Corp
Photovac Monitoring Instruments
SEE AD ON PAGE 51, 57
SRI Instruments
Sensidyne Inc
Sierra Monitor Corp
Tekmar Co
Terra Universal Inc

Analytical Instruments, Rentals
ASC Professionals
American Environmental Instruments Inc
CAE Instrumental Rental
Diversified Well Products Inc
Dyna-FID Inc
Entech Instruments Inc
Hazzo Services Inc
Instrumentation Northwest Inc (INW)
Intek Corp/Rent-Alyzer
Novalyx Corp
Oilind Safety
Omega Engineering Inc
SEE AD ON PAGE 2
Pace Transducer Div of
CJ Instruments Inc
R E Wright Environmental Inc
SRI Instruments
Scott Lawson Group Inc, The

Analytical Instruments, Wastewater
Air Instruments & Measurements Inc
American Environmental Instruments Inc
American Sigma Inc
Anatel Corp
Arthur Technology Inc
BTG Div of Spectris Technologies Inc
Bio-Tek Instruments
Bioscience Inc
Buck Scientific Inc
CEA Instruments Inc
Capital Controls Co Inc



913-681-3913

Challenge Environmental Systems Inc
E S Industries
EIT
FCI Environmental Inc
Foxboro Co, The
George Fischer Inc
Great Lakes Instruments



800-227-4224

Hach Co
Horiba Instruments Inc
Ionics Inc
Iso Inc Environmental Div
KVA/Analect
Lakewood Instruments An Osmonics Co
Leeman Labs Inc
Mettler-Toledo Process Analytical Inc
Microbics Corp
Monitek Technologies Inc
Myriad Industries
Novalyx Corp

Oi Analytical
Omega Engineering Inc
SEE AD ON PAGE 2
Orbeco Analytical Systems Inc
Perkin-Elmer Corp
Polybac Corp
Rosemount Analytical Inc
Royce Instrument Corp
SRI Instruments
Schneider Instrument Co
Sensidyne Inc
Sentex Systems Inc
Shimadzu Scientific Instruments Inc
Spectrex Corp
Taylor Technologies Inc
Tekmar Co



408-749-0994

Turner Designs Inc
SEE AD ON PAGE 21
YSI Inc
Zellweger Analytics Inc

Analytical Instruments, Water
American Environmental Instruments Inc
Anatel Corp
Atlantic Screen & Mfg
BTG Div of Spectris Technologies Inc
Bio-Tek Instruments
Brinkmann Instruments Inc
Buck Scientific Inc
CDS Analytical Inc
CEA Instruments Inc
Capital Controls Co Inc
Chemetics Inc
Coastal Environmental Systems
Diversified Well Products Inc
E S Industries
EIT
Foxboro Co, The
G O Environmental Inc
George Fischer Inc
Great Lakes Instruments
Hach Co
Handar
Hazzo Services Inc
Horiba Instruments Inc
Instrumentation Northwest Inc (INW)
Intek Corp/Rent-Alyzer
Ionics Inc
Johnson Yokogawa Corp
Leeman Labs Inc
Mars Co
Mettler-Toledo Process Analytical Inc
Microbics Corp
Monitek Technologies Inc
Myriad Industries
Novalyx Corp
OI Analytical
Orbeco Analytical Systems Inc
Osmonics Inc
SEE AD ON PAGE 25
Perkin-Elmer Corp
Progressive Equipment Corp
QED Environmental Systems Inc
Rosemount Analytical Inc
SRI Instruments
Schneider Instrument Co
Sensidyne Inc
Spectrex Corp
Spectrogram Corp
Taylor Technologies Inc
Tekmar Co
Testo Inc
SEE AD ON PAGE 72

Turner Designs Inc
SEE AD ON PAGE 21, 83
YSI Inc
Zellweger Analytics Inc

Analytical/Research Services
Air Toxics Ltd
American Standards Testing Bureau Inc
Aqua Tech Environmental Laboratories Inc (ATEL)
BioVir Laboratories Inc

Diversified Well Products Inc
Dyncorp Environmental Energy & Natl Security Programs
EAS Laboratories
EcoAnalysis Inc
Electrosynthesis Co Inc
Environmental Science & Engineering Inc
HES Inc
Hazen & Sawyer
Heritage Environmental Services Inc
Midwest Laboratories Inc
NUCON Intl Inc
Northwest Environmental Services
Testing & Training
Pittsburgh Activated Carbon Services Inc
Raytheon Environmental Svcs/
Raytheon Engineers & Construction
Rollins Environmental Services
Structure Probe Inc/SPI Supplies
Triangle Laboratories Inc
Ultra-Research Inc
Yamada Science & Art Corp (YSA)

Annunciators/Alarms
Acromag Inc
CEA Instruments Inc
Dancer Communications Inc
Dwyer Instruments Inc
Phonetics Inc

Aquifer Restoration
Adrian Brown Consultants Inc
Allied Environmental Consultants Inc
Aral Geoscience Inc
Bioscience Inc
Bovar Environmental



617-621-8181

Camp Dresser & McKee Inc
ChromatoChem Inc
ECO Purification Systems USA Inc
ESSC (Earth Systems & Solutions Corp)
Earth Remediation Services Inc
EnsoTech Inc
Environmental Systems Engineering Inc
GeoTrans Inc
Grant Environmental
Groundwater Technology Inc
In-Horizontal Technologies Inc
In-Situ Inc
SEE AD ON PAGE 31
Integrated Environmental Solutions Inc
SEE AD ON PAGE 35, 87
Keating Environmental Management Inc
Northwest Environmental Services
Testing & Training
R E Wright Environmental Inc

Asbestos Abatement Services/Equipment
A P Buck Inc
A&J Environmental Supply
Allego Industries
Allied Environmental Consultants Inc



219-892-5151

American Engineering
American Sty & Abatement Products Inc
Armsco
Bennett & Associates Inc
Bovar Environmental
CTL Environmental Services
Childers Products Co
Clean World Engineering Ltd
Cura Inc
DeMarco MAX VAC Corp
Dival Safety Equipment
Drums Inc
Dustvent Inc
Environmental Information Assoc, The
Environmental Science & Engineering Inc
Environmental Waste Technology Inc
Fiberlock Technologies Inc
First Fabrics Inc
Gilan Instruments
Goodway Technologies Corp
Hazleton Environmental Consultants Inc
International Protective Coatings Corp
International Safety Instruments

How often do you check your oil in water?



How about 24 hours a day, 365 days a year.

Recognized worldwide for its non-fouling, low maintenance operation, the TD-4100 continuously monitors BTEX, gasoline, diesel, jet fuel, crude and refined oils in water. The TD-4100 is accurate and sensitive. The detection limit for gasoline is 5 ppb in clean water. Uninterrupted remote monitoring for continuous discharge, treatment verification, process control, pollution

prevention, or leak detection saves time, money, and sampling hassles. The TD-4100 supports regulated discharge permits for wastewater. The performance of each monitor is guaranteed to meet your needs. Nearly 25 years of experience is built into every TD-4100. Call 408/749-0994 or telefax 408/749-0998 for more information.

 **TURNER DESIGNS**
845 W. Maude Avenue • Sunnyvale, CA 94086
(408) 749-0994 • FAX (408) 749-0998

Circle 82 on card.

Asbestos Abatement Services/Equipment

Jaca Corp
 Millipore Corp
 National Marker Co
 National Technical Information Service
 Neoterik Health Technologies Inc
 North Safety Products,
 Safety Equipment Div
 North Safety Products
 Occupational Health & Hygiene
 Corp of America
 Olinid Safety
 P W Stephens Contractors Inc
 Packaging Research & Design
 Pactec Inc
 R E Wright Environmental Inc
 RHH Foam Systems Inc
 RMT Inc
 Radon Detection Systems Inc
 Roy F Weston Inc
 Scott Lawson Group Inc, The
 Sensidyne Inc
 Staplex Air Sampler Div
 Sverdrup Civic Inc
 Sverdrup Environmental Inc
TRC Environmental Corp
 SEE AD ON PAGE 32
 Traverse Group, The
 Williams Environmental Services Inc
 Wonder Makers Inc

Backflow Preventers
 CLA-VAL Co
 Flomatic Valves Corp
 Hersey Products
 Jerman, Daniel L, Co
 Plast-O-Matic Valves Inc
 R E Wright Environmental Inc

Bacteria/Enzymes
 A&J Environmental Supply
 Alken-Murray Corp
 Biopreme Ltd

Bioscience Inc
 General Environmental Science Corp
 Johnson & Associates Consulting
 Kruck Environmental Services Inc
 Medina Agriculture Products Co Inc
 Midwest Laboratories Inc
 Odor Control Co Inc
 Osprey Biotechnics
 Polybac Corp
 Probiotic Solutions
 Serengett Environmental
 Symbion Chemicals Inc
 W Canning Inc

Bacteriological Supplies

General Environmental Science Corp
 Kruck Environmental Services Inc
 Medina Agriculture Products Co Inc
 Osprey Biotechnics
 ProBios Inc
 Serengett Environmental

Baffles/Booms

American Shty & Abatement Products Inc
 Containment Systems
 Environetics Inc
 Environmental Products & Services Inc
 Environmental Recovery Resources Inc
 Export Technologies Inc
 Hyde Products
 Plastic Fusion Fabricators Inc
 Slobbar Products Corp
 Sunshine Technology Corp

Baghouse Monitoring

auburn INTERNATIONAL
 800-255-5008
 Auburn International Inc
 SEE AD ON PAGE 69

August Mack Environmental Inc
 Clean Air Engineering
 R E Wright Environmental Inc
 Roy F Weston Inc
 Spectronics Corp

Baghouses

Ambient Engineering Inc
 Andersen 2000 Inc
 August Mack Environmental Inc

Cedarapids
 A Raytheon Company
 319-363-3511

Cedarapids Inc A Raytheon Co
 Ducon Environmental Systems Inc
 Dustvent Inc
 Griffin Environmental Co Inc
 Mac Environmental
 Pego Systems Inc
 Precision Environmental International Inc
 Seghers Dinamec Inc
 United McGill Corp
 Universal Process Equipment Inc
 Wheelabrator Clean Air Systems Inc
 Zurn Air Systems

Balances

American Environmental Instruments Inc
 Ben Meadows Co
 ELE Intl Inc/Soiltest Products Div
 Myraid Industries
 Ohaus Corp
 Perkin-Elmer Corp

Balers

Art's Manufacturing & Supply
 Baler Equipment Co
 Ben Meadows Co
 Boart Longyear Co

Biological Testing Apparatus/Supplies

Dustvent Inc
 Environmental Products & Services Inc
 Hazco Services Inc
 Marathon Equipment Co
 Mid-States Recycling Systems Inc
 Orwak USA Inc
 Piqua Waste Equipment Inc
 Wheaton Science Products

Barriers

BRD Noise & Vibration Control Inc
 C H Hanson Co, The
 Concrete Systems Inc
 Containment Systems
 Conti Environmental Inc
 Drums Inc
 MPC Containment Systems Ltd
 United Process Inc
 W Canning Inc

Batching/Blending Systems

Acron Inc
 Conti Environmental Inc
 Environmental Systems Engineering Inc
 Fluid Dynamics Inc
 George Fischer Inc
 Ista Energy Systems Corp
 International Reserve Equipment Corp
 Jerman, Daniel L, Co
 Universal Process Equipment Inc
 Vibra Screw Inc
 Zimmerman Industries Inc

Bentonite

Atlantic Screen & Mfg
 Baler Equipment Co
 Boart Longyear Co
 Colloid Environmental Technologies Co
 Conti Environmental Inc
 Diversified Well Products Inc
 Wyo-Ben Inc

Bin Discharger

Acron Inc
 General Kinematics Corp
 K-Tron America
 Mac Environmental
 Vac-U-Max
 Vibra Screw Inc

Bin/Hoppers

Acron Inc
 Bergen Barrel & Drum Co
 Brown-Minneapolis Tank
 Gemstone Environmental
 Mac Environmental
 Poly Processing Co
 U S Best
 Universal Process Equipment Inc

VAC-U-MAX
 800-289-8228

Vac-U-Max
 Vibra Screw Inc

Bioassay

Aqua Tech Environmental
 Laboratories Inc (ATEL)
 Chester Environmental
 ERM Group Inc
 EcoAnalysis Inc
 Environmental Science & Engineering Inc
 High Plains Consortium Inc
 Inchcape Testing Services/Environmental
 Laboratories
 Midwest Laboratories Inc
 RMT Inc

Biological Testing Apparatus/Supplies

Arthur Technology Inc

BIOREMEDIATION
How to get more ACTION from your "bugs".



Chase them with a "BEAR".
 The powerful Brown Bear horizontal auger tractor NOW gives you even better:

- Mixing of inoculants or nutrients
- Liquid application and incorporation in a single pass
- Greater capacity with angled auger head
- Particle size reduction with paddle auger design
- Self Propelled and Attachment models available



BROWN BEAR
 BROWN BEAR CORP., CORNING, IA 50841
 PHONE: 515-322-4220, FAX: 515-322-3527

ENVIRONMENTAL LIABILITY INSURANCE

- Asbestos Abatement
- Lead Abatement
- UST Removal
- Hazwaste Remediation
- Consultants & Labs

Workers' Compensation Contract Surety Bonds

AS AMERICAN SAFETY
Insuring the Environment®

Rated A (Excellent) by A.M. Best

(800) 388-3647
 1900 The Exchange #450
 Atlanta, GA 30339

Biological Testing Apparatus/Supplies

Bio-Tek Instruments
BioTrol Inc
Bioscience Inc



913-681-3913

Challenge Environmental Systems Inc
Columbus Instruments
Diversified Well Products Inc
Entech Instruments Inc
Industrial Glassware
Medina Agriculture Products Co Inc
National Technical Information Service
Spectronics Corp
Testwell Craig Laboratories Inc
YSI Inc

Bioremediation

ABB Environmental Services Inc
Adirondack Environmental Associates Inc
Adrian Brown Consultants Inc
Alton Geoscience Inc
BioTrol Inc
Bioscience Inc
Blasland Bouck & Lee Inc
Blymyer Engineers Inc
Bovar Environmental
Braun Intertec Corp
Brown Bear Corp

CDM Camp Dresser & McKee Inc.
617-621-8181

Camp Dresser & McKee Inc
Century West Environmental Inc
Chester Environmental
Dames & Moore
Delta Environmental Consultants Inc
Diversified Well Products Inc
EIMCO Process Equipment
ENSR
ERM Group Inc
Earth Remediation Services Inc
Eckenfelder Inc
Ensotech Inc
Envirex Inc
Environmental Products & Services Inc
Environmental Restoration Systems
Environmental Science & Engineering Inc
Environmental Systems Engineering Inc
Environmental Tank Systems Inc (ETS)
Envirotrol Inc
Foth & Van Dyke
Gemstone Environmental
General Environmental Science Corp
GeoTrans Inc
Geraghty & Miller Inc a Heidmij Co
Grant Environmental
Groundwater & Environmental Services Inc
Groundwater Technology Inc
Harding Lawson Associates
SEE AD ON PAGE 34
Heritage Environmental Services Inc
High Plains Consortium Inc
Horizontal Technologies Inc
Hydro Group Inc
Integrated Environmental Solutions Inc
SEE AD ON PAGE 35, 87
Johnson & Associates Consulting
Keating Environmental Management Inc
Kruock Environmental Services Inc
Landtec Products Inc
Mazzei Injector Corp
Medina Agriculture Products Co Inc
Metcalfe & Eddy
Millennium Science & Engineering Inc
Morrison Knudsen Corp
National Technical Information Service
National Technical Systems
Osprey Biotechnics
Petrol REM Inc
Polybac Corp
ProBios Inc
Probiotic Solutions
QED Environmental Systems Inc
R E Wright Environmental Inc
RMT Inc
Raytheon Environmental Svcs/
Raytheon Engineers & Construction
Recon Environmental Corp
Roy F Weston Inc
Serengeti Environmental

S **Sevenson Environmental Services, Inc.**
716-284-0431

Sevenson Environmental Services Inc
Sharp & Associates Inc
Soil Solutions Inc
Solvay Intertox
Sverdrup Civic Inc
Sverdrup Environmental Inc
Symbion Chemicals Inc
Traverse Group, The
W Canning Inc

Blowers

Allegro Industries
American Safety & Abatement Products Inc
Andersen 2000 Inc
Baird/Forde & Co Inc
Busch Inc
Cellicote Air Pollution Control
Direct Safety Co
Dival Safety Equipment
Dual Div Met-Pro Corp
Dustvent Inc

EG&G ROTRON
914-246-3401

EG & G Rotron - Industrial Products Div
EPG Companies
Environmental Restoration Systems
Environmental Systems Engineering Inc
Export Technologies Inc
Finn Corp
Gardner Denver Machinery Inc
General Equipment Co
Hartzell Fan Inc
Hazco Services Inc
Lamson Corp
M-D Pneumatics Div Tutill Corp
Mac Environmental
Meyer & Sons Inc, Wm W
Nederman Inc
New York Blower Co
Pego Systems Inc
Phelps Fan Inc
QED Environmental Systems Inc
R E Wright Environmental Inc
Remediation Service Int'l
Spencer Turbine Co, The
Stokes Vacuum Inc
Terra Universal Inc
Universal Process Equipment Inc
Zum Air Systems

BOD Test Equipment

Anatel Corp
Bioscience Inc



913-681-3913

Challenge Environmental Systems Inc
Columbus Instruments
Hach Co
Hazco Services Inc
Myraid Industries
Polybac Corp
Wheaton Science Products
Wilkins-Anderson Co
YSI Inc

Boiler Feedwater Treatment Equipment

Alken-Murray Corp
Bryan Steam Corp
Capital Controls Co Inc
Chemetics Inc
Ionics Inc
Johnson Yokogawa Corp
Lakewood Instruments An Osmonics Co
Mazzei Injector Corp
Millipore Corp
Osmonics Inc
Rosemount Analytical Inc
Samsco Inc
SEE AD ON PAGE 101
Smith & Loveless Inc
U S Environmental Engineering Inc
United States Filter Corp

Carbon Adsorption

Boilers

Bryan Steam Corp
International Reserve Equipment Corp
Pego Systems Inc
Progressive Equipment Corp
Universal Process Equipment Inc

Burners

Applied Utility Systems Inc
College Research Corp (CORECO)
Eclipse Combustion Inc
John Zink Co Div Koch Engineering Co
Process Combustion Corp
Remediation Service Int'l

Bushings

Boston Gear
Jerman, Daniel L Co
Parker Hannifin Corp

Calibration

A P Buck Inc
American Environmental Instruments Inc
BGI Inc
BIOS Int'l Inc
Brooklyn Thermometer Co Inc
Coastal Leasing Inc
Dival Safety Equipment
Enviro-nics Inc
Extch Instruments
G O Environmental Inc
GTS Duratek
Gilan Instruments
Hazco Services Inc
Instruments Direct Inc

KIN-TEK
Good Analysis Requires the Good Calibration
800-326-3627

Kin-Tek
MKS Instruments Inc
Mast/Keystone Inc
Met One Instruments Inc
SEE AD ON PAGE 43, 85

Monitor Labs Inc
NUCON Int'l Inc
RKI Instruments Inc
Scott Specialty Gases
Sensidyne Inc
Solomat - Neotronics
VICI Meltronics Inc
Valien Safety Supply Co

Calorimeters

Myraid Industries
Perkin-Elmer Corp

Carbon Adsorption

Activated Carbon Tech
August Mack Environmental Inc
Calgon Carbon Corp
Cameron Environmental Inc
Cameron-Yakima Inc
Camp Dresser & McKee Inc
Carbon Activated
Carbonair Environmental Systems Inc
Carbtrol Corp
College Research Corp (CORECO)
Colloid Environmental Technologies Co
Dedert Corp
Dual Div Met-Pro Corp
Ducon Environmental Systems Inc



313-459-6800

Durr Environmental Systems
Dustvent Inc
Environmental Products & Services Inc
Environmental Systems Engineering Inc
Envirotrol Inc
General Carbon Corp
GeoPure Systems & Services
GeoTrans Inc
HEMCO Corp
Highland Tank & Mtg Co
Hydro Group Inc
JBI Spray Booths & Finishing Systems
Met-Pro Corp Systems Div
NUCON Int'l Inc
Northwestern Carbon

Meteorological Instruments

- Wind Speed
- Wind Direction
- Air Temperature
- Relative Humidity
- Precipitation
- Barometric Pressure
- Solar Radiation
- Data Loggers
- Recorders
- Towers & Elevators
- Lightning Protection
- Software
- Installation & Calibration
- Field Service
- Technical Assistance
- Service & Repair
- Instrument Shelters

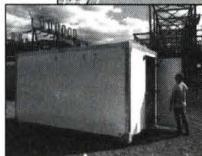
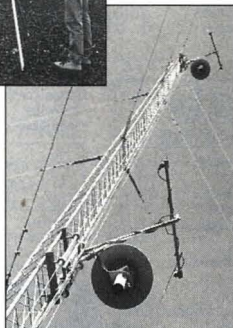

Met One Instruments

1600 Washington Blvd., Grants Pass, OR 97526
Phone (503) 471-7111, Fax (503) 471-7116

Carbon Adsorption

Pittsburgh Activated Carbon Services Inc
QED Environmental Systems Inc
R E Wright Environmental Inc
Remedial Systems Inc
Smith & Loveless Inc
Soli Solutions Inc
Therm Tech Inc
Treatment Technologies

Unisorb Corp.
713-943-3753

Unisorb Corp

VARA INTERNATIONAL
Division of Calgon Carbon Corporation
407-567-1320

Vara Intl Div of Calgon Carbon Corp
Western Filter Co
Wheelabrator Technologies Inc

Carbon Dioxide Detectors

AGA Gas Inc
Advanced Pollution Instrumentation Inc
Air Instruments & Measurements Inc
American Environmental Instruments Inc
American Shty & Abatement Products Inc
Anarad Inc
Aramsoo
Argus Environmental Monitoring
Bruel & Kjaer Instruments Inc
CEA Instruments Inc
California Analytical Instruments Inc
Clean Air Engineering
Columbus Instruments
Dival Safety Equipment
Dwyer Instruments Inc
EIT
Ecom America
Enmet Corp
Environmental Products & Services Inc

FOXBORO
800-321-0322

Foxboro Co, The
Gas Tech Inc
Hazzo Services Inc
Horiba Instruments Inc
Intek Corp/Perit-Alyzer
McNeill Intl
Metrosonics Inc

MIL-RAM Technology, Inc.
408-293-5085

Mil-Ram Technology Inc
Monitor Labs Inc
National Draeger Inc
RKI Instruments Inc
SCI-TEC Instruments Inc
Scott Lawson Group Inc, The
Sensidyne Inc
Servomex Co Inc
Siemens Energy & Automation Inc
Sierra Monitor Corp
Solomat - Neotronics
Spectra Gases Inc
Summit Analyzers
Transducer Research Inc
Vaisala Inc
Valien Safety Supply Co

Carbon Monoxide Detectors

Advanced Pollution Instrumentation Inc
Air Instruments & Measurements Inc
American Environmental Instruments Inc
Anarad Inc
Aramsoo
Argus Environmental Monitoring
BGI Inc
Biosystems Inc
Bruel & Kjaer Instruments Inc
CEA Instruments Inc
California Analytical Instruments Inc
Clean Air Engineering

Control Instruments Neslab Corporation
201-575-9114

Control Instruments Corp
Dasibi Environmental Corp
Detcon Inc
Dival Safety Equipment
EIT
Ecom America
Enmet Corp
Environmental Products & Services Inc

FOXBORO
800-321-0322

Foxboro Co, The
Gas Tech Inc
Hazzo Services Inc
Horiba Instruments Inc
Industrial Scientific Corp
Intek Corp/Perit-Alyzer
Interscan Corp
Lumidor Safety Products
McNeill Intl
Metrosonics Inc
Mil-Ram Technology Inc
Monitor Labs Inc
National Draeger Inc
RKI Instruments Inc
Rosemount Analytical Inc
SCI-TEC Instruments Inc
SKC Inc
Scott Lawson Group Inc, The
Sensidyne Inc
Sensor Electronics Corp
Servomex Co Inc
Siemens Energy & Automation Inc
Sierra Monitor Corp
Solomat - Neotronics
Spectra Gases Inc
Summit Analyzers
Transducer Research Inc
U S Industrial Products Co Inc
Valien Safety Supply Co

Carbon Reactivation

BARNEBEY & SUTCLIFFE CORPORATION
800-886-2272

Barnebey & Sutcliffe Corp
Calgon Carbon Corp
Cameron Environmental Inc
Cameron-Yakima Inc
Carbon Activated
Carbonair Environmental Systems Inc
Carbrol Corp
College Research Corp (CORECO)

ENVIRONMENTAL, INC.
412-741-2030

Envirofil Inc
General Carbon Corp
Northwestern Carbon
Wheelabrator Clean Air Systems Inc
Wheelabrator Technologies Inc

Carbon Regeneration Systems

Barnebey & Sutcliffe Corp
Calgon Carbon Corp
Cameron Environmental Inc
College Research Corp (CORECO)
Ducon Environmental Systems Inc
General Carbon Corp

Hankin Environmental Systems, Inc.
908-722-9595

Hankin Environmental Systems Inc
JBI Spray Booths & Finishing Systems
Mazzei Injector Corp
NUCON Intl Inc
Northwestern Carbon
Therm Tech Inc

Cascade Impactors

Graseby
SEE AD ON PAGE 15, 89

Intek Corp/Perit-Alyzer
SKC Inc
Scott Lawson Group Inc, The

Catalysts

Adwest Technologies Inc
Airex Corp
Allied Signal Inc Automotive &
Industrial Catalysts
American Technologies Group Inc
Calgon Carbon Corp
Celite Corp
ECO Purification Systems USA Inc

ENGELHARD
908-205-6618

Engelhard Corp
Envirox Inc
Goal Line Environmental Technologies
Grace Tec Systems
Medina Agriculture Products Co Inc
Met-Pro Corp Systems Div
Norton Chemical Process Products Corp
Probiotic Solutions
Prototech Co, The
Remediation Service Intl
Winsor & Jerauld
Wolverine (Massachusetts) Corp

Cathodic Protection Equipment

Atlantic Screen & Mfg Co
Highland Tank & Mfg Co
Mars Co
Purestream Inc
Tapecoat Company, The

Centrifuges

Alfa Laval Sharpies,
Alfa Laval Separation Inc

ANZOR 817-465-5611

Andritz-Ruthner Inc
Baler Machine Co
Bird Equipment Co Inc
Brinkmann Instruments Inc
CINC

SEE AD ON PAGE 25

NO TRO SYSTEMS, INC. 713-699-0152

Flo Trend Systems Inc
SEE AD ON PAGE 64, 91

FloTweg
Hyde Products
International Reserve Equipment Corp
Krebs Engineers Inc
Myriad Industries
Sanborn Technologies
Spencer Turbine Co, The
Tegal Scientific Inc
Universal Process Equipment Inc
Waste-Tech Inc

Chemical Information

Ariel Research Corp
Conatech Consulting Group Inc
Cytec Industries Inc

FLOW GEMINI
800-934-5917

GRC Intl Inc/Flow Gemini Systems
Moore Enviro-Chemical
Occupational Health & Hygiene
Corp of America
STP Specialty Technical Publishers Inc

Chemical Odor Control

nuTech environmental corp.
800-321-8824

NuTech Environmental Corp

Chemical Storage Buildings

Basco Inc
Camber Corp

CHEMGUARD
800-377-4800

Chemguard Corp, The
Concrete Systems Inc
Convalet Inc
Cytec Industries Inc
Enpac Corp
Environmental Compliance Products
Environmental Container Corp
Environmental Products & Services Inc
Environmental Products Inc
HEMCO Corp

HAZ-MAT CONTAINMENT CORPORATION
800-943-6510

Haz-Mat Containment Corp

HAZ-SAFE
Buildings by Design
412-842-2130

Haz-Safe Buildings Div of CID Assoc Inc
SEE AD ON PAGE 72, 94

Haz-Stor

SEE AD ON PAGE 45, 114

JBI Spray Booths & Finishing Systems
Johnson Yokogawa Corp
Justrite Manufacturing
Justrite Manufacturing Co LLC
New Pig Corp

SEE AD ON PAGE 49, 99

P&D
502-776-7776

P & D Systemtech Inc
Parkline Inc
Plasti-Fab Inc
Precision Quincy Corp
ROF Environmental Systems Inc
Safe Environmental Storage
Safety Storage Inc

SEE AD ON PAGE 39, 79

Shields Environmental Corp
Sprung Instant Structures Inc
Stanley Storage Systems
UltraTech Intl Inc

Chemicals

Bioprem Ltd
Chem Service Inc
Chemical Lime Co
Colloid Environmental Technologies Co
Containment Corp
Crown Technology Inc
Cytec Industries Inc
General Chemical Corp
Hach Co
Inorganic Ventures Inc
JT Baker Div of Mallinckrodt Baker Inc

LC 412-826-5230

LabChem Inc
Moore Enviro-Chemical
Myriad Industries
National Technical Information Service
ProBios Inc
Probiotic Solutions
Red Bird Service
Restek Corp
Ricca Chemical Co
Scott Specialty Gases
Solvay Interox
Stiles-Kern Div Met-Pro Corp
Stuchausen Inc
Structure Probe Inc/SPI Supplies
Sunshine Technology Corp
Taylor Technologies Inc
ULTRA Scientific
W Canning Inc

Chillers

Baldwin Environmental Inc

Clarifiers

Croll Reynolds Co Inc
Edwards Engineering Corp
Neslab Instruments
Progressive Equipment Corp
Samsco Inc

SEE AD ON PAGE 101
Structure Probe Inc/SPI Supplies
Universal Process Equipment Inc

Chlorination Equipment

Blue-White Industries
Capital Controls Co Inc
Cheminer Inc
Chlorinator Inc
Export Technologies Inc
Ionics Inc
Mazzei Injector Corp
Pepon Systems Inc
Purestream Inc

Chlorine Detectors

American Environmental Instruments Inc
Anarad Inc
Argus Environmental Monitoring
Baracharac Inc
Biosystems Inc
CEA Instruments Inc
Capital Controls Co Inc
Chlorinator Inc
Detcon Inc
Dival Safety Equipment
EIT
Enmet Corp
Hazzo Services Inc
Industrial Scientific Corp
Intek Corp/Perit-Alyzer
International Sensor Technology
Interscan Corp
Lumidor Safety Products
Mast/Keystone Inc
McNeill Intl
Metrosonics Inc

MIL-RAM Technology, Inc.
408-293-5085

Mil-Ram Technology Inc
Myriad Industries
Orbeo Analytical Systems Inc
Omega Engineering Inc

SEE AD ON PAGE 2

RKI Instruments Inc
Rosemount Analytical Inc
SPI Instruments
Sensidyne Inc
Sensor Electronics Corp
Sierra Monitor Corp
Spectra Gases Inc
Transducer Research Inc
U S Industrial Products Co Inc
Zellweger Analytics Inc

Chromatographs

American Environmental Instruments Inc
American Scientific Instrumentation
Buck Scientific Inc
CDS Analytical Inc
Celite Corp
Hazzo Services Inc
Heath Consultants Inc
Intek Corp/Perit-Alyzer
OJ Analytical
Perkin-Elmer Corp
Photovac Monitoring Instruments
SEE AD ON PAGE 51, 57
SPI Instruments
Sensidyne Inc
Sentex Systems Inc
Valien Safety Supply Co

Clamps, Pipe

Camber Corp
Jerman, Daniel L, Co
Oetiker Inc
Plasti-Fab Inc

Clarifiers

Alfa Laval Sharpies,
Alfa Laval Separation Inc
American Technologies Group Inc
Baler Equipment Co
Brown-Minneapolis Tank



Groundwater Remediation In Less Than 30 Days, For A Fraction Of The Cost, At A Fixed Fee.

**They Said It Couldn't Be Done.
But We Do It Repeatedly.**

QUICK-PURGE® is the fastest and most cost-effective solution for groundwater and soil remediation.

The revolutionary IES QUICK-PURGE® technology uses a geological approach to remediation. It removes contaminants from the subsurface without removing soil and groundwater. Not only is QUICK-PURGE® much faster than traditional methods—it takes just weeks instead of years – but it also does a more thorough job and costs up to fifty percent less. All at a unique fixed-fee contractual rate.

IES developed the QUICK-PURGE® technique to achieve remediation QUICKLY. And to parts-per-billion levels.

They said it couldn't be done. But IES did it. And we can do it for you. For information, call us today.

IES

INTEGRATED ENVIRONMENTAL
SOLUTIONS, INC.

An Inc. 500 Company

3787 Old Middleburg Road, Suite 3
Jacksonville, FL 32210
(904) 778-1188 FAX (904) 778-0201

• Soil & Groundwater Remediation • Contamination Assessment • Phase I & II Environment Assessment
• Environmental Consulting • Government/Regulation Liaison

Clarifiers

C G S
516-467-1600

Clean Gas Systems Inc
Davco Div Davis Water & Waste Industries Inc
EIMCO Process Equipment
Envirex Inc
Export Technologies Inc
Flo Trend Systems Inc

SEE AD ON PAGE 64, 91

Framco Environmental Technologies
Great Lakes Environmental Inc
Hyde Products
Hydro Group Inc
Industrial Filter & Pump Mfg Co
International Reserve Equipment Corp
Krebs Engineers Inc
Lakeside Equipment Corp
MLE
Met-Pro Corp Systems Div
Purestream Inc
Remedial Systems Inc

Smith & Loveless Inc
Suburbia Systems Corp
Tenco Hydro Inc
Treatment Technologies
U S Environmental Engineering Inc
Universal Process Equipment Inc
Walker Process Equipment
Div of McNish Corp
Western Filter Co
Wheelabrator Clean Water Inc - HPD Div
Wheelabrator Clean Water Inc - Memtek Div

Clarifiers Drive Units

DBS Manufacturing Inc
EIMCO Process Equipment
Envirex Inc
Export Technologies Inc
Walker Process Equipment
Div of McNish Corp

Clean Rooms/Supplies

American City & Abatement Products Inc
CEA Instruments Inc

Dival Safety Equipment
Durr Environmental Systems
HEMCO Corp
Lansom Corp
Magid Glove & Safety Mfg Co
Myriad Industries
Porta-Fab Corp
Raytheon Environmental Svcs/
Raytheon Engineers & Construction
Sensidyne Inc
Spectronics Corp
Structure Probe Inc/SPI Supplies
Terra Universal Inc
United McGill Corp
Valien Safety Supply Co

Cleaning Equipment/Supplies

Allegro Industries
CINC

SEE AD ON PAGE 25

DeMarco MAX VAC Corp
EMC Equipment Manufacturing Corp
Georgia Steel & Chemical Co Inc

Goald Co
Landa Water Cleaning Systems
New Pig Corp
SEE AD ON PAGE 49, 99
Nilfisk of America Inc
Pace Transducer Div of
CJ Instruments Inc
RMJ Machinery Inc
Remco Products Corp
Spraying Systems Co
Sunshine Technology Corp
Tegal Scientific Inc
W Canning Inc
Wheelabrator Technologies Inc

Cleaning/Flushing Services

Environmental Products & Services Inc
Heritage Environmental Services Inc
Superior Industrial Maintenance Co Inc

Clothing, Protective

AGA Gas Inc
American City & Abatement Products Inc
Aramco
Argus Environmental Monitoring
Bird-X Inc
Chem-Tex Corp
Dival Safety Equipment
Environmental Products & Services Inc
Exploration Products
SEE AD ON PAGE 71
First Fabrics Inc
Hazzo Services Inc
ILC Dover Inc
Magid Glove & Safety Mfg Co
Myriad Industries
New Pig Corp
SEE AD ON PAGE 49, 99
Seton Identification Products
Stanley Storage Systems
Valien Safety Supply Co

Coagulation

American Technologies Group Inc
Crown Technology Inc
General Chemical Corp
Stockhausen Inc
W Canning Inc
Western Filter Co
Wyo-Ben Inc

Coatings/Linings

Abrest Corp
Advanced Polymer Sciences Inc
Aramco
C H Hanson Co, The
Cortec Corp
Dampney Co Inc
Goald Co
Highland Tank & Mfg Co
International Protective Coatings Corp

Morton
312-807-2345

Morton International
Plastic Fusion Fabricators Inc
Plastronics Inc
PolySpec Corp
Raven Lining Systems
Saundersen
Seaman Corp

sentry
POLYMERS, INC.
409-233-0312

Sentry Polymers Inc
Thremec Co Inc
Wisconsin Protective Coat

COD Instrumentation

Anatel Corp
Bioscience Inc
Clean Gas Systems Inc
Hach Co
Ionics Inc
Orbeo Analytical Systems Inc

Combustion Control Instruments

Colorimeters

Air Instruments & Measurements Inc
Assay Technology Inc
Bioscience Inc
Brinkmann Instruments Inc
CEA Instruments Inc
Hach Co
Hazzo Services Inc
Helma Cells Inc
Monitek Technologies Inc
Myriad Industries
Omega Engineering Inc
SEE AD ON PAGE 2
Orbeo Analytical Systems Inc
Polybac Corp
Valien Safety Supply Co

Combustible Gas Detectors

AGA Gas Inc
Air Instruments & Measurements Inc
American Environmental Instruments Inc
American City & Abatement Products Inc
Anarad Inc
Aramco
Argus Environmental Monitoring
BGI Inc
Bacharach Inc
Biostystems Inc
CEA Instruments Inc

Control Instruments Corporation
201-575-9114

Control Instruments Corp
Detcon Inc
Dival Safety Equipment
Enmet Corp
Environmental Products & Services Inc

FOXBORO
800-321-0322

Foxboro Co, The
Gas Tech Inc
Grace Industries Inc
Hazzo Services Inc
Health Consultants Inc
Intek Corp/Pent-Alyzer
International Sensor Technology
Jerman, Daniel L, Co
Lumidat Safety Products
Metrosonics Inc

MIL-RAM
Technology, Inc.
408-293-5085

Mil-Ram Technology Inc
National Draeger Inc
Photovac Monitoring Instruments
SEE AD ON PAGE 15, 17

RKI Instruments Inc
Rosemount Analytical Inc
Scott Lawson Group Inc, The
Sensidyne Inc
Sensor Electronics Corp
Servomex Co Inc
Siemens Energy & Automation Inc
Sierra Monitor Corp
Spectra Gases Inc
Summit Analyzers
Testo Inc
SEE AD ON PAGE 72

Transducer Research Inc
U S Industrial Products Co Inc
Valien Safety Supply Co
Zellweger Analytics Inc

Combustion Control Instruments

Air Instruments & Measurements Inc
Applied Utility Systems Inc
Bacharach Inc
Bailey Controls Co
CEA Instruments Inc
Dwyer Instruments Inc
Foxboro Co, The
L & L Process Industries Inc
Land Combustion
Omega Engineering Inc
SEE AD ON PAGE 2
Remediation Service Intl

PRODUCTS/SERVICES

Multi-Module:
Air • Solid/Liquid Waste •
Wastewater

Once you compare
i-STEPS™,
there's no comparison.

The screenshot displays the i-STEPS software interface with several windows open. The main window shows a 'Process Mail Key Information' table with columns for State Code, County Code, Facility ID, Group Number, Process Number, and Process Description. Below this is a 'Facility Emissions by Year' bar chart. Other windows show 'Process Mail Information', 'Site Process Identifier', and 'Emissions Data' tables. The 'Emissions Data' table includes columns for Pollutant, Unit, and various emission metrics.

i-STEPS™ is the most advanced, easy-to-use solution available for environmental data management.

Use *i*-STEPS to prepare annual emission reports, track emissions for demonstrating daily compliance, and support Title V applications.

- Microsoft® Windows™-based
- Network-ready, multi-user environment
- Full compatibility with EPA's AIRS
- Single entry of data, automatic data validation
- Built-in and user-definable emission formulas
- Unique, multiple views of emissions/process streams
- Sophisticated security controls and comprehensive audit trail
- A full range of standard, ad-hoc reports and graphs
- Customizable screens, optional CAD interface, and more



Plus, you get complete, on-site training as well as comprehensive technical support.

PES
PACIFIC ENVIRONMENTAL SERVICES, INC.

Telephone: 919/941-0333
Telefax: 919/941-0234
Internet: i-steps@rtp.pes.com
Home page: <http://www.pes.com/pes>

*i-STEPS is a trademark of Pacific Environmental Services, Inc. "Microsoft Windows" is a trademark of Microsoft Corporation.

Combustion Control Instruments

Rosemount Analytical Inc.
Siemens Energy & Automation Inc.



Summit Analyzers

Communication Equipment

Advanced Control Systems Corp
American Sfty & Abatement Products Inc
Dancer Communications Inc
David Clark Co Inc
Earmark Inc
Environmental Dynamics Inc

Exploration Products

SEE AD ON PAGE 71

Hazco Services Inc
Magellan Systems Corp
Met One Instruments Inc

SEE AD ON PAGE 43, 85

Phonetics Inc
Valien Safety Supply Co

Communitors/Grinders

Enviro-Care Co
JWC Environmental
Wheelabrator Technologies Inc

Compactors

Compacting Technologies
Dustvent Inc
Enviro-Care Co
Hertz Equipment Rental Corp
Marathon Equipment Co

New Pig Corp

SEE AD ON PAGE 49, 99

Orwak USA Inc
Piqua Waste Equipment Inc
RMJ Machinery Inc
Rampactor Inc
S & G Enterprises Inc
SPS Industrial Engineering Inc
Sebright Products
Stanley Hydraulic Tools
Terra Consulting Group Inc

Compliance Audits



Environmental Services Inc

Composting Systems

Air Dimensions Inc
American Pulverizer Co
BioGro Div Wheelabrator Clean Water Systems Inc
Brown Bear Corp
DBS Manufacturing Inc
ESSC (Earth Systems & Solutions Corp)
Probiotic Solutions
Shred-Tech
Spencer Turbine Co. The
Wheelabrator Technologies Inc
Wheelabrator Water Technologies Inc Bio Gro Div

Compressors

Allegro Industries
Atlantic Fluidics Inc



BVS Inc
Blackmer/Dover Resources Co
Environmental Restoration Systems
Environmental Systems Engineering Inc
Gardner Denver Machinery Inc
GeoPure Systems & Services
Hazco Services Inc
Hertz Equipment Rental Corp
Pego Systems Inc
QED Environmental Systems Inc
Seagull Technical Services



Timco Manufacturing Inc

Computer Control

ASOMA/WTC Engineering
Amvc Controls
Foboro Co. The
National Instruments
Omega Engineering Inc
SEE AD ON PAGE 2
Perkin-Elmer Corp
QED Environmental Systems Inc
R E Wright Environmental Inc

Computer Databases

A V Systems Inc
ASOMA/WTC Engineering
Adrian Brown Consultants Inc
Blymer Engineers Inc
Chemical Safety Corp
Digitronics Sarnet
Donley Technology
Dyncorp Environmental Energy & Natl Security Programs
Earth Info Inc
EcoAnalysis Inc
Envires Corp
Environmental Data Resources Inc
Environmental Dynamics Inc
Environmental Resource Center
GTS Duratek
General Sciences Corp
GeoTrans Inc
Grant Environmental
Haz Mat Control Systems Inc
Jordan Systems
Knorr Associates
Legi-Slate

SEE AD ON PAGE 10, 113

Logical Technology Inc

SEE AD ON PAGE 49, 94

N B Olewine Co Inc. The
National Technical Information Service
North American Software Inc
Pittsburgh Activated Carbon Services Inc
Restek Corp
Sewall, James W
StratFact Software
Strong Environmental Inc
TRC Environmental Corp
SEE AD ON PAGE 32
Terra Consulting Group Inc
Tracker Technologies Inc
Ultra-Research Inc
Waid & Associates
Wixel Inc

Computer Devices

Digitronics Sarnet
Diversified Well Products Inc
Entech Instruments Inc

TS Duratek

Computer Modeling (Air, Groundwater, Hazard & Risk)

Adrian Brown Consultants Inc



Air Science Consultants Inc
Alton Geoscience Inc



Art's Manufacturing & Supply
August Mack Environmental Inc
BEE-Line Software
Blasland Bouck & Lee Inc
Bovar Environmental
Braun Intertec Corp
CDM Federal Programs Corp
CTL Environmental Services



Camp Dresser & McKee Inc
DNV Technica
Dames & Moore
Delta Environmental Consultants Inc
Donley Technology
Dyncorp Environmental Energy & Natl Security Programs
ERM Group Inc
ESSC (Earth Systems & Solutions Corp)
Earth Info Inc
EcoAnalysis Inc
EnviroMetrics Software Inc
Foth & Van Dyke
GRC Intl Inc/Flow Gemini Systems



General Sciences Corp

GeoTrans Inc
Grant Environmental
Groundwater Services Inc
Harding Lawson Associates
SEE AD ON PAGE 34
Hazclean Environmental Consultants Inc
High Plains Consortium Inc
Holzmacher McLendon & Murrell PC
HydroGeologic Inc
ICF Kaiser International Inc
Intergraph
Logical Technology Inc
SEE AD ON PAGE 49, 99
Morrison Knudsen Corp
National Technical Information Service
Omega Engineering Inc
SEE AD ON PAGE 2
Pacific Environmental Services Inc
SEE AD ON PAGE 56, 88
R E Wright Environmental Inc
Raytheon Environmental Svcs/
Raytheon Engineers & Construction
Restek Corp
Roy F Weston Inc

S W Cole Engineering Inc
SSOE Inc
StratFact Software
Sverdrup Environmental Inc
TRC Environmental Corp
SEE AD ON PAGE 32
Traverse Group, The
Trinity Consultants Inc



Waid & Associates
Walk, Haydel & Associates Inc
Yamada Science & Art Corp (YSA)

Computer Software, Chemical Database



A V Systems Inc

PRODUCTS/SERVICES

THE BEST IN AIR MONITORING PRODUCTS

Graseby's PM-10/2.5 Dichotomous Sampler

PMTM 10/2.5

Are you interested in COARSE and FINE Particulates?

Are you interested in collecting 2.5 micron particles for your data base?



GRASEBY HAS THE ONLY EPA DESIGNATED REFERENCE METHOD DICHOT!

1-800-241-6898 The Standard Of Excellence In Air Compliance Technology

GRASEBY

500 TECHNOLOGY COURT, SMYRNA, GA 30082
TEL: 770-319-9999 FAX: 770-319-0336

Computer Software, Management (MSDS)

Computer Software, Management (MSDS)



313-973-3000

AV Systems Inc
Achieve! Technology Inc
Chemical Safety Corp
Clark Boardman Callaghan
Computational Mechanics Inc
Corbus A Div of CMS Inc
Dakota Software Corp
Decade Software Corp
Digitronics Sixnet
Donley Technology
Dyncorp Environmental Energy & Natl Security Programs

Computer Software, Regulatory Compliance



313-973-3000

AV Systems Inc
ASOMA/WTC Engineering
Achieve! Technology Inc
Ariel Research Corp
Chemical Safety Corp
Citation Publishing Inc (CPI)
SEE AD ON PAGE 9, 119
Clark Boardman Callaghan
Corbus A Div of CMS Inc
Dakota Software Corp
Decade Software Corp
Donley Technology
Dyncorp Environmental Energy & Natl Security Programs



E-Soft Inc
ERM Group Inc
EnviroMetrics Software Inc
Environmental Dynamics Inc
Environmental Profiles Inc
SEE AD ON PAGE 71
Environmental Resource Center



GRC Intl Inc/Flow Gemini Systems
GTS Duratek
General Sciences Corp
GeoTrans Inc
Harper & Shuman Inc
Haz Mat Control Systems Inc
HazWaste Technologies Corp
ICF Kaiser International Inc
Ibex Technologies
Intec Controls
Intergraph
Jordan Systems
Knorr Associates

Logical Technology Inc
SEE AD ON PAGE 49, 99
North American Software Inc
Pacific Environmental Services Inc
SEE AD ON PAGE 56, 88
Permit Tracker Software
Pittsburgh Activated Carbon Services Inc
Roy F Weston Inc
Sewall, James W
Site Assessment Software
Sothsel Inc
SEE AD ON PAGE 67, 91
StratFac Software
Tracker Technologies Inc
Veeder-Root Co
Wald & Associates
Wixel Inc

Computer Software, Environmental Management



313-973-3000

AV Systems Inc

Computer Software, Management, Hazardous Waste



North American Software Inc



General Sciences Corp
ICF Kaiser International Inc
IHS Regulatory Products - EarthLaw
J J Keller & Associates
JT Baker Div of Mallinckrodt Baker Inc
Jordan Systems
Knorr Associates
Martin Goffman Associates
National Technical Information Service
Pacific Environmental Services Inc
SEE AD ON PAGE 56, 88
Pittsburgh Activated Carbon Services Inc
Roy F Weston Inc
Sewall, James W
Sothsel Inc
SEE AD ON PAGE 67, 91
Vallen Safety Supply Co

Concentrators

Barnebey & Sutcliffe Corp
Burns & McDonnell Waste Con. Inc
Cameron Environmental Inc



Durr Environmental Systems



Engelhard Corp
Ertelch Instruments Inc
Flo Trend Systems Inc
SEE AD ON PAGE 64, 91
Grasbey

SEE AD ON PAGE 15, 89
International Reserve Equipment Corp
Smith & Loveless Inc
Tekmar Co
Weatherly Inc
Wheaton Science Products

Conductivity Instrumentation

Advanced Data Systems
American Environmental Instruments Inc
American Sigma Inc
Anatel Corp
Ben Meadows Co
Campbell Scientific Inc
Capital Controls Co Inc
Dwyer Instruments Inc
ELE Intl Inc/Sothsel Products Div
Ertelch Instruments
Foxboro Co, The
G O Environmental Inc
GeoGuard Inc
Geotech Environmental Equipment Inc
Global Water
Great Lakes Instruments
Hach Co
Hazzo Services Inc
Horiba Instruments Inc
HydroLab Corp
SEE AD ON PAGE 40, 118
Instrumentation Northwest Inc (INW)
Intek Corp/Rent-Alyzer
Johnson Yokogawa Corp
Lakewood Instruments An Osmonics Co
Montek Technologies Inc
Myriad Industries
Myron L Co
Novalyne Corp
Osmonics Engineering Inc
SEE AD ON PAGE 2
Orbeco Analytical Systems Inc
Osmonics Inc
SEE AD ON PAGE 25
Progressive Equipment Corp
Rosemount Analytical Inc
Scherid Instrument Co
Schnico Lts
Solomat - Neotronics
Taylor Technologies Inc
Unidata America
YSI Inc
Zellweger Analytics Inc



Logical Technology Inc
SEE AD ON PAGE 49, 99
National Instruments
National Technical Information Service
North American Software Inc
Omega Engineering Inc
SEE AD ON PAGE 2
Permit Tracker Software
Pittsburgh Activated Carbon Services Inc
Primatch Inc
RegScan Inc
Sharp & Associates Inc
Site Assessment Software
Sothsel Inc
SEE AD ON PAGE 67, 91
Trinity Consultants Inc
Vallen Safety Supply Co
Veeder-Root Co
Wixel Inc

Computer Software, SARA Reporting



313-973-3000

AV Systems Inc

Computer Software, Training

Achieve! Technology Inc
Chemical Safety Corp
Danatec Educational Services Ltd
Enecon Services Inc
Environmental Resource Center
GRC Intl Inc/Flow Gemini Systems
GTS Duratek

Consulting Services

AAA Environmental
ABB Environmental Services Inc
AGA Gas Inc



Adrian Brown Consultants Inc
Advanced Data Systems
Air Resource Specialists Inc



Air Science Consultants Inc
Air Source Technologies Inc
Air Toxics Ltd
AirNova Inc
Alexander & Associates

Allied Environmental Consultants Inc
Alton Geoscience Inc
American Standards Testing Bureau Inc
Applied Utility Systems Inc
August Mack Environmental Inc
BNA Communications Inc
Blaslund Bouck & Lee Inc
Blymeyer Engineers Inc
Braun Intertec Corp
Brown & Caldwell
CTL Environmental Services



Camp Dresser & McKee Inc
Capsule Environmental Engineering Inc
Cartwright Consulting Co
Century West Environmental Inc
Chester Environmental
Clean Air Engineering



Comco Inc
Conatech Consulting Group Inc
Corbus A Div of CMS Inc
Cura Inc
DRE Technologies
Dames & Moore
Danatec Educational Services Ltd
Delta Environmental Consultants Inc
Ducon Environmental Systems Inc



Durr Environmental Systems
ELB & Associates Inc
ENSR
ERASE Inc
ERM Group Inc
ESSOC (Earth Systems & Solutions Corp)
Eckentelder Inc
Emilco Associates
Emilco-dga Inc
Enecon Services Inc
Ertelch Instruments Inc
Enviro-Assist Inc
Enviroair Consultants Inc
Environex Inc
Environmental Compliance Products
Environmental Dynamics Inc
Environmental Products & Services Inc
Environmental Profiles Inc
SEE AD ON PAGE 57, 94
Environmental Resource Center
Environmental Safety Services
Environmental Science & Engineering Inc
Environmental Support Solutions
Environmental Training Group Inc
Envroplan Inc
Export Technologies Inc
GTS Duratek



General Sciences Corp
GeoTrans Inc

Consulting Services

Geraghty & Miller Inc a Heidmij Co
Grant Environmental
Grassroots Marketing Inc
Groundwater & Environmental Srv Inc
Groundwater Services Inc
Groundwater Technology Inc
HDR Engineering Inc
HMTRI Hazardous Material Handling & Research Institute
Haley & Aldrich Inc
Harding Lawson Associates
SEE AD ON PAGE 34

Hazen & Sawyer
Heritage Environmental Services Inc
High Plains Consortium Inc
Holzmacher McLendon & Murrell PC
Hubbell Roth & Clark Inc
HydroGeologic Inc
ICF Kaiser International Inc
Integrated Environmental Solutions Inc
SEE AD ON PAGE 35, 87

Interlab Inc
J J Keller & Associates
Jaca Corp
Johnson & Associates Consulting
Joseph Marketing Inc
K & B Design Inc
Keating Environmental Management Inc
Kemper Risk Management Services
Killam Associates
Kruok Environmental Services Inc
L J Broutman & Assoc Ltd
Licata Energy & Environmental Consultants Inc
Lockwood Greene Technologies Inc
Mabbett & Associates Inc
Martin Goffman Associates
Metcalf & Eddy



Metco Environmental
Moore Environmental-Chemical
Monson Knudsen Corp
NATION Intl Inc
National Technical Information Service
Neri LLC
Network Environmental Systems Inc (NES)



Northwest Environmental Services
Testing & Training
Occupational Health & Hygiene Corp of America
P & I Consulting Ltd
Pacific Environmental Services Inc
SEE AD ON PAGE 56, 88

Peter George Associates Inc
Pittsburgh Activated Carbon Services Inc
Pollution Research & Technology Inc (PRT)
Precision Environmental International Inc
Primatch Inc
ProBios Inc
Proud Data Service
R E Wright Environmental Inc
RMJ Machinery Inc
RMT Inc
Raytheon Environmental Svcs/
Raytheon Engineers & Construction
Recon Environmental Corp
Right-To-Know Training Institute
Roy F Weston Inc
S W Cole Engineering Inc
SSOE Inc
Scott Lawson Group Inc, The
Sebright Products
Sewall, James W
Shields Environmental Corp
Strong Environmental Inc
Superior Industrial Maintenance Co Inc
Sverdrup Environmental Inc
TNT Technology Co
TRC Environmental Corp
SEE AD ON PAGE 32
Teledyne Brown Engineering - Environmental Services
Terra Consulting Group Inc
Tracer Research Corp
SEE AD ON PAGE 41
Traverse Group, The
Ultra-Research Inc

Consulting Services

University of Illinois Institute of Labor & Indust. Relat.
Valien Safety Supply Co
Vanco Engineering Group
Vulcan Iron Works Inc



Ward & Associates
Wear Inc
Western Water Consultants Inc
Williams Environmental Services Inc
Wonder Makers Inc
Yamada Science & Art Corp (YSA)

Continuing Education

Southern Methodist University
Texas State Technical College (TSTC)

Contracting Services

Adronack Environmental Associates Inc
Air Source Technologies Inc
Alternative Remedial Technologies Inc
Alton Geoscience Inc
Camp Dresser & McKee Inc
Conatech Consulting Group Inc
Cont. Environmental Inc
Dames & Moore
Delta Environmental Consultants Inc
Durr Environmental Systems
Enercon Services Inc
Environmental Products & Services Inc
Environmental Resource Center
Groundwater & Environmental Srv Inc
Groundwater Technology Inc
HMTRI Hazardous Material Handling & Research Institute
Harding Lawson Associates
SEE AD ON PAGE 34
Heritage Environmental Services Inc

ICF Kaiser International Inc
Integrated Environmental Solutions Inc
SEE AD ON PAGE 35, 87
Johnson & Associates Consulting
K-F Environmental Technologies Inc
Kruuk Environmental Services Inc
L J Brouman & Assoc Ltd
Maxymilian Technologies Inc
Morrison Knudsen Corp
P & I Consulting Ltd
Pittsburgh Activated Carbon Services Inc
R E Wright Environmental Inc
Raytheon Environmental Svcs/
Raytheon Engineers & Construction
Remediation Service Intl



Sevenson Environmental Services Inc
Soil Solutions Inc
Superior Industrial Maintenance Co Inc
Sverdrup Environmental Inc
Tracer Research Corp
SEE AD ON PAGE 41
Traverse Group, The
Wheelabrator Clean Water Inc - HPD Div
Williams Environmental Services Inc

Controllers

ASOMA/WTC Engineering
Advanced Control Systems Corp
Ametek Process & Analytical Instruments Div
BTR Instruments
Badger Meter Inc
Bailey Controls Co
Boston Gear
Crompton Instruments Ltd
Crompton Instruments NA

Custom Switches
Dwyer Instruments Inc
EPG Companies
Environmental Restoration Systems
Environmental Systems Engineering Inc
Foxboro Co, The
George Fischer Inc
Johnson Yokogawa Corp
Micro Analytical Laboratories Inc
Modutec Inc
National Controls Corp
Omega Engineering Inc
SEE AD ON PAGE 2
Osmonics Inc
SEE AD ON PAGE 25

Phonetics Inc
QED Environmental Systems Inc
R D McMillan Co Inc
Remediation Service Intl
Rhombus Technology
Spectra Gases Inc
Spencer Turbine Co, The

Conveyors

ABB Air Preheater Inc Ehsram Prods
Aercon
American Pulverizer Co



Gedarapids Inc A Raytheon Co



Durr Environmental Systems
Enviro-Care Co
General Kinematics Corp
Hyde Products

Intralox Inc
Mid-States Recycling Systems Inc
Multitek Inc
Portec C E D Environmental Products
Prodeva Inc
Screw Conveyor Corp
Serpenix Conveyor Corp
Universal Process Equipment Inc



Vac-U-Max
Vibra Screw Inc

Cooling Tower Water

Alken-Murray Corp
Andco Environmental Processes Inc
Capital Controls Co Inc
Chemetics Inc
Chester Environmental
Cortec Corp
Ionics Inc
Lakewood Instruments An Osmonics Co
Millipore Corp
Oil Skimmers Inc
Osmonics Inc
SEE AD ON PAGE 25

Ozact Inc
Pactec Inc
Progressive Equipment Corp
Rosemount Analytical Inc
Samsco Inc
SEE AD ON PAGE 101
SeaMetrics Inc
U S Environmental Engineering Inc
W Canning Inc
Water Equipment Technologies Inc
Wheelabrator Clean Water Inc - HPD Div
Worldwide Technology Inc

Corrosion Instrumentation/Protection

Cooling Towers



Clean Gas Systems Inc
Delta Cooling Towers Inc
Raytheon Environmental Svcs/
Raytheon Engineers & Construction
Spraying Systems Co
Universal Process Equipment Inc

Core Sampler



Art's Manufacturing & Supply
Associated Design & Manufacturing Co
Ben Meadows Co
Boart Longyear Co
Dival Safety Equipment
Hazco Services Inc
Wonder Makers Inc

Corrosion Instrumentation/Protection

Atlas Minerals & Chemicals Inc
Cortec Corp
Crown Technology Inc
Plast-O-Matic Valves Inc
PolySpec Corp
Raven Lining Systems
Stiles-Kem Div Met-Pro Corp
Tapecoat Company, The
W Canning Inc

PRODUCTS/SERVICES

Site Assessment Software

for Windows

Deliver your report in half the time---

**THIS MEANS MONEY
to YOU!!!**

Designed FOR the environmental professional....

BY environmental professionals!

Standardize your report--Save Time and Money!

- ◆ Complete with WYSIWYG word processor for automatic ASTM-compatible report format
- ◆ Customize and print report in the word processor
- ◆ NREP and ASTM reference documents and a Notebook feature for your notes in the field

Call for **FREE** Sample Report
Environmental Site Assessment.....\$695.00

softshel, inc.

P.O. Box 10813, Oklahoma City, OK 73140
(405) 733-2002

MAKE A DEWATERING & SLUDGE SEPARATING FILTER OUT OF YOUR CONTAINER

Permanently Mounted or Removable Vertical Panel Filter: A retrofit for all conventional sized roll-off sludge containers.

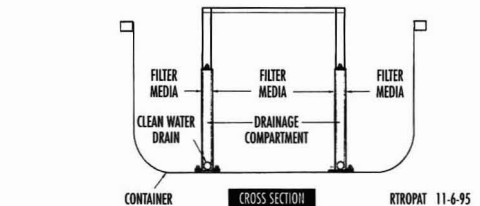
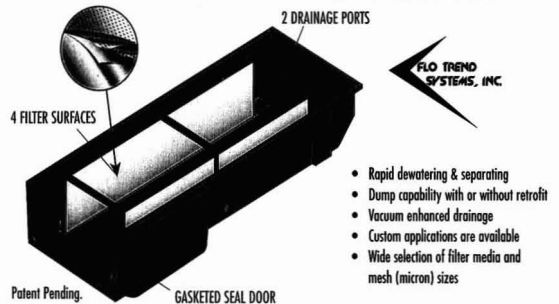

A simply designed vertical panel filter that will convert any conventional container or dump truck into an efficient and effective dewatering and separating container. This conversion can be made with little or no change to your existing inventory by: 1) installing slide lock ratchets on the walls of the container and 2) providing two outside drainage ports for the clarified water. A hose yoke and vacuum pump may be used with the Vertical Panel Filter without any alterations to the container. Call us for a demonstration or pilot study.

FLO TREND SYSTEMS • 707 LEHMAN • (713) 699-0152 • FAX: (713) 699-8054

Corrosion Resistant Blower

Corrosion Resistant Blower



EG & G Rotron - Industrial Products Div

Couplings

Atlantic Screen & Mfg
Boston Gear
Civacon
Guardian Industries
Jerman, Daniel L, Co



MMC International Corp
SEE AD ON PAGE 24

Mars Co
NewAge Industries Inc
Pacer Pumps Div of ASM Industries Inc
Parker Hannifin Corp
Parker Hannifin Corp/Q C Div
Spencer Turbine Co, The
Swagelok Companies, The

Covers/Domes

C H Hanson Co, The
Exploration Products
SEE AD ON PAGE 71

ILC Dover Inc
Plastronics Inc
Reel Industries Inc
Rusmar Inc
Synthetic Inc

Crushers

American Gas Products Inc
American Pulverizer Co
Basco Inc
Brinkmann Instruments Inc
Compacting Technologies
Hyde Products
International Reserve Equipment Corp
Jeffrey/Indresco
Prodeva Inc
RMJ Machinery Inc
Rampactor Inc
S & G Enterprises Inc
SRS Industrial Engineering Inc
Universal Engineering
Universal Process Equipment Inc

Cyclones

Abresist Corp
Andersen 2000 Inc
August Mack Environmental Inc
BGI Inc
Blower Application Co Inc



Cedarapids Inc A Raytheon Co



Clean Gas Systems Inc
Ducon Environmental Systems Inc
Duddick Inc
Dusvent Inc
Flo Trend Systems Inc
SEE AD ON PAGE 64, 91

Gemstone Environmental
Griffin Environmental Co Inc
Griswold Controls
Hazzo Services Inc
Hyde Products
International Reserve Equipment Corp
Krebs Engineers Inc
Mac Environmental
Meyer & Sons Inc, Wm W
Mid-States Recycling Systems Inc
Misroix Inc
New Pig Corp
SEE AD ON PAGE 49, 99

Universal Process Equipment Inc
Warman Intl Inc

Dampers

Pego Systems Inc
Plastronics Inc
United McGill Corp

Data Acquisition Equipment

ASOMA/WTC Engineering
Acromag Inc
Advanced Control Systems Corp
Advanced Data Systems
Air Instruments & Measurements Inc
American Sigma Inc
Anarad Inc
Applied Technologies Inc
Bailey Controls Co
Boart Longyear Co
CEA Instruments Inc
Campbell Scientific Inc
Clean Air Engineering
Coastal Environmental Systems
Coastal Leasing Inc
Dancer Communications Inc
Digitronics Sixnet
Dival Safety Equipment
Environmental Systems Corp
Extch Instruments
Handar
Hawk America Inc
Instrumentation Northwest Inc (INW)
Interscan Corp
Johnson Yokogawa Corp
Keithley Metrabyte
Kipp & Zonen
Logic Beach Inc



MSI/Mechanical Systems Inc
Met One Instruments Inc
SEE AD ON PAGE 43, 85

Metrosnics Inc
Monarch Instrument
Monitor Labs Inc
National Instruments
Novalex Corp
Omega Engineering Inc
SEE AD ON PAGE 2
Perkin-Elmer Corp
Rite in the Rain Fieldbooks
SRI Instruments
Schneider Instrument Co
Sierra Monitor Corp
Testo Inc
SEE AD ON PAGE 72

Tracker Technologies Inc
YSI Inc

Data Loggers

ASOMA/WTC Engineering
Acromag Inc
Advanced Data Systems
Air Instruments & Measurements Inc
Applied Technologies Inc
Badger Meter Inc
Ben Meadows Co
Brady USA Inc Sigmarm Div
Campbell Scientific Inc
Clean Air Engineering
Coastal Environmental Systems
Coastal Leasing Inc
Dancer Communications Inc
Dasibi Environmental Corp
Digitronics Sixnet
Environmental Products & Services Inc
Environmental Systems Corp
Extch Instruments
GeoGuard Inc
Global Water
HNU Systems Inc
Handar



In-Situ Inc
SEE AD ON PAGE 31
Instrumentation Northwest Inc (INW)
Instruments Direct Inc
Interscan Corp
Keithley Metrabyte
Logic Beach Inc

Magellan Systems Corp
McNeill Intl

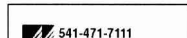

Met One Instruments Inc
SEE AD ON PAGE 43, 85

Metrosnics Inc
Monarch Instrument
Mount Sopris Instrument Co Inc
Novalex Corp
Omega Engineering Inc
SEE AD ON PAGE 2

Onset Computer Corp
Phonetics Inc
QED Environmental Systems Inc
R E Wright Environmental Inc
RKI Instruments Inc
Rite in the Rain Fieldbooks
Rustrak Instruments
Sierra Monitor Corp



Telog Instruments Inc
Testo Inc
SEE AD ON PAGE 72

Tracker Technologies Inc
Unidata America

Deaerators/Degasifiers

Coll Reynolds Co Inc
Hungerford & Terry Inc
Mazzei Injector Corp

Debris Baskets



Haliday Products Inc

Dechlorination Equipment

Blue-White Industries
Capital Controls Co Inc
Chlorinator Inc
Mazzei Injector Corp
Rosemount Analytical Inc
Smith & Loveless Inc
Water Equipment Technologies Inc
Western Filter Co

Decontamination Equipment

Advanced Containment Systems Inc



Ameri-can Engineering
EET Inc
Exploration Products
SEE AD ON PAGE 71

Global Technologies
Oilind Safety
Spencer Turbine Co, The
Vulcan Iron Works Inc

Deep Well Systems

A C Schultes of NJ, MD, & DE
EPG Companies
Environmental Products & Services Inc
Environmental Restoration Systems
Environmental Systems Engineering Inc
Hawk America Inc
Hydro Group Inc
In-Situ Inc
SEE AD ON PAGE 31
Instrumentation Northwest Inc (INW)
QED Environmental Systems Inc
R E Wright Environmental Inc
Sharp & Associates Inc

Defoaming/Degreasing Equipment

New Pig Corp
SEE AD ON PAGE 49, 99
S C Altman & Associates



Safety-Kleen Corp
U S Environmental Engineering Inc
W Canning Inc

Dehumidifiers

Xchanger Inc

Deionizers

Applied Membranes Inc
GeoPure Systems & Services
Hungerford & Terry Inc
Industrial Filter & Pump Mfg Co
Kinetic Inc Engineered Systems Div
Smith & Loveless Inc
U S Environmental Engineering Inc
United States Filter Corp
Water Equipment Technologies Inc

Demineralizers

Hungerford & Terry Inc
Hydro Group Inc
Industrial Filter & Pump Mfg Co
Ionics Inc
Osmonics Inc
SEE AD ON PAGE 25
Smith & Loveless Inc
Treatment Technologies
United States Filter Corp
Water Equipment Technologies Inc
Western Filter Co

Density Instrumentation

Brooklyn Thermometer Co Inc
Peek Measurement

Desalination Equipment

Applied Membranes Inc
Aqua-Chem Inc



Desalination Systems Inc
Exploration Products
SEE AD ON PAGE 71

Ionics Inc
Noell Inc
Osmonics Inc
SEE AD ON PAGE 25

S C Altman & Associates
U S Environmental Engineering Inc
United States Filter Corp
Vallen Safety Supply Co
Water Equipment Technologies Inc
Wheelabrator Technologies Inc

Detectors

Ben Meadows Co
CEA Instruments Inc
Campbell Scientific Inc
Capital Controls Co Inc
Detcon Inc
Dival Safety Equipment
EBW Inc
EIT



Foxboro Co, The
Gas Tech Inc
Gem Sensors Div
Global Equipment Marketing Inc
Grace Industries Inc
HNU Systems Inc
Hazzo Services Inc
Helma Cells Inc
Industrial Scientific Corp
Intek Corp/Rent-Alyzer
International Sensor Technology

Disinfection Equipment, Water

Jerman, Daniel L, Co
McNeill Intl
Mil-Ram Technology Inc
Milltronics Inc
National Draeger Inc
New Pig Corp
SEE AD ON PAGE 49, 99
Oilind Safety
Omega Engineering Inc
SEE AD ON PAGE 2

Phonetics Inc
RKI Instruments Inc
SKC Inc
Scott Specialty Gases
Sensidyne Inc
Sensor Electronics Corp
Sierra Monitor Corp



Spectra Gases Inc
Spectronics Corp
3M Occupational Health & Environmental Safety Div



Tracer Research Corp
SEE AD ON PAGE 41

Transducer Research Inc
Ultra-Research Inc
Vaisala Inc
Vallen Safety Supply Co
Zellweger Analytics Inc

Diffusers

Aeromix Systems Inc
Carbrol Corp
Davco Div Davis Water & Waste
Industries Inc
EIMCO Process Equipment



EnviroQuip International Inc



Flo Trend Systems Inc
SEE AD ON PAGE 64, 91

New Pig Corp
SEE AD ON PAGE 49, 99

Purestream Inc
United McGill Corp
Vallen Safety Supply Co
Walker Process Equipment Div of
McNish Corp

Digesters

Brinkmann Instruments Inc
Brown-Minneapolis Tank
Deep Shaft Technology Inc
EIMCO Process Equipment
Envirex Inc
Hach Co
Purestream Inc
Smith & Loveless Inc
United McGill Corp
Walker Process Equipment
Div of McNish Corp
Wheelabrator Clean Water Inc - HPD Div

Directories

Moore Enviro-Chemical
Pittsburgh Activated Carbon Services Inc

Disinfection Equipment, Water

Chlorinator Inc
EIMCO Process Equipment
Georgia Steel & Chemical Co Inc
National Technical Information Service
Osmonics Inc
SEE AD ON PAGE 25
Pepon Systems Inc

Disinfection Equipment, Water

Smith & Loveless Inc
U S Environmental Engineering Inc
Water Equipment Technologies Inc
Western Filter Co

Dissolved Oxygen Detectors

American Environmental Instruments Inc
American Sigma Inc
Bioscience Inc
Capital Controls Co Inc
Coastal Leasing Inc
EIT
Foxboro Co. The
Global Water
Great Lakes Instruments
Hach Co
Hazco Services Inc
Horiba Instruments Inc
HydroLab Corp
SEE AD ON PAGE 40, 118

ISI Innovative Sensors, Inc.
800-835-5474

Innovative Sensors Inc
Instrumark International Inc
Instrumentation Northwest Inc (INW)
Intex Corp/Rent-Alyzer
Johnson Yokogawa Corp
Myriad Industries
Novalyx Corp
Omega Engineering Inc
SEE AD ON PAGE 2
Rosemount Analytical Inc
Royce Instrument Corp
Schneider Instrument Co
Solomat - Neotronics
Wheaton Science Products
Wilkins-Anderson Co
YSI Inc

Dissolved Solids Detectors

HydroLab Corp
SEE AD ON PAGE 40, 118
Instrumentation Northwest Inc (INW)
Myron L Co
Osmonics Inc
SEE AD ON PAGE 25
Wilkins-Anderson Co

Distillation Equipment

APV Anhydro-Separation Technologies
Aqua-Chem Inc
Barnebey & Sutcliffe Corp
Brinkmann Instruments Inc
Glas-Col
Jaeger Products Inc
Millipore Corp
RGF Environmental Systems Inc
SRS Industrial Engineering Inc
Samsco Inc
SEE AD ON PAGE 19
Solvent Recovery Systems Inc
U S Environmental Engineering Inc
Universal Process Equipment Inc

VITA INTERNATIONAL
Division of Calgon Carbon Corporation
407-567-1320

Vara Intl Div of Calgon Carbon Corp

Dredges

Elliott Machine Corp Intl

MSI
608-825-2055

IMS Inc (Innovative Material Systems Inc)

LWIPIT HOG
Premier
Water
800-243-1406

Liquid Waste Technology
SEE AD ON PAGE 65
SRS Cissatull Inc

Dredging Services

AMSCO Inc
CDM Federal Programs Corp

Conti Environmental Inc
DRE Technologies
Elliott Machine Corp Intl
K-F Environmental Technologies Inc
Liquid Waste Technology
SEE AD ON PAGE 65

Probiotic Solutions
Sevenson Environmental Services, Inc.
716-284-0431

Sevenson Environmental Services Inc
Sharp & Associates Inc

Drilling, Water

A C Schultes of NJ, MD, & DE
Art's Manufacturing & Supply
Boat Longyear Co
Braun Intertec Corp
Diversified Well Products Inc
Heritage Environmental Services Inc
Hydro Group Inc
Kruck Environmental Services Inc
Sharp & Associates Inc

Drum Decheater

Basco Inc
Drums Inc
Hazco Services Inc
Justrite Manufacturing
New Pig Corp
SEE AD ON PAGE 49, 99

RMJ Machinery Inc
U S Best

Drum Pumps

Basco Inc
Dival Safety Equipment
Filterspun
Geotech Environmental Equipment Inc
Hazco Services Inc
Lutz Pumps Inc
New Pig Corp
SEE AD ON PAGE 49, 99
Omega Engineering Inc
SEE AD ON PAGE 2
Pacer Pumps Div of ASM Industries Inc
Serfilco Lts
Setlcho Div Met-Pro Corp
Stanley Storage Systems
U S Best

Drums

American Sity & Abatement Products Inc
Basco Inc
Bay Marketing
Bergen Barrel & Drum Co
Chem-Tainer Industries
Containment Corp
D G Supplies Inc
Dival Safety Equipment
Drums Inc

EP Container Corp. 800-211-0311

EP Container Corp
Environmental Products & Services Inc
Hazco Services Inc
New Pig Corp
SEE AD ON PAGE 49, 99

North American Environmental Corp
Remco Products Corp
Skolnik Industries Inc
Soil Solutions Inc
U S Best
UltraTech Intl Inc
Valien Safety Supply Co

Drying Equipment

ABB Air Preheater Inc Raymond Prods
APV Anhydro-Separation Technologies

AMSC
817-465-5611

Andritz-Ruthner Inc
Brown Bear Corp
Dedert Corp

Deltach Engineering Inc
Epon International Systems Inc
Gemstone Environmental
Georgia Steel & Chemical Co Inc
Gienro Inc
Grace Tec Systems
Hankison Intl
Heyl & Patterson Inc Renneburg Div
International Reserve Equipment Corp
L & L Process Industries Inc
MEC Co

NIRO
410-997-8700

Niro Inc
Pactec Inc
Seghers Dinamec Inc
Stokes Vacuum Inc

Stord, Inc.
An Aker Company
910-668-7727

Stord Inc
Swenson Process Equipment Inc
United McGill Corp
Universal Process Equipment Inc
Vulcan Iron Works Inc
Wheelabrator Technologies Inc
Wheelabrator Water
Technologies Inc Bio Gro Div
Wolverine (Massachusetts) Corp
Wysmont Co Inc

Ducts/Stacks/Chimneys

Advanced Containment Systems Inc
Dual Div Met-Pro Corp
Ducon Environmental Systems Inc
JBI Spray Booths & Finishing Systems
L & L Process Industries Inc
Micro Air Air Cleaners by Metal-Fab Inc
Plastronics Inc
Raytheon Environmental Svcs/
Raytheon Engineers & Construction
Schuller International Inc
Seghers Dinamec Inc
United McGill Corp
Wheelabrator Clean Air Systems Inc

Dust Collector Accessories/Supplies

A P Buck Inc
AAF Intl
Advanced Containment Systems Inc

auburn INTERNATIONAL
800-255-5008

Auburn International Inc
SEE AD ON PAGE 69

Dival Safety Equipment
Dustvent Inc
Gilian Instruments
Griffin Environmental Co Inc
JBI Spray Booths & Finishing Systems
Lamson Corp
Mac Environmental
Meyer & Sons Inc. Wm W
Nederman Inc
Nilfisk of America Inc
Pactec Inc
Precision Environmental International Inc
Precision Wire Products Inc
Scientific Dust Collectors
Seghers Dinamec Inc
Sensidyne Inc
Spectronics Corp
Wedding & Associates Inc
Wheelabrator Clean Air Systems Inc
Zurn Air Systems

Dust Collector Controls

AAF Intl
August Mack Environmental Inc
Ducon Environmental Systems Inc
Dustvent Inc
Griffin Environmental Co Inc
JBI Spray Booths & Finishing Systems
Mac Environmental
National Controls Corp
Precision Environmental International Inc
Scientific Dust Collectors

Spencer Turbine Co, The
United Air Specialists Inc

Dust Suppression Systems

Advanced Containment Systems Inc

ag-chem
612-933-9006

Ag-Chem Equipment Co Inc
American Sity & Abatement Products Inc
August Mack Environmental Inc
C H Hanson Co, The
Dustvent Inc
Mac Environmental

Martin Marietta Magnesia Specialties
800-648-7400

Martin Marietta Magnesia Specialties Inc
Minox Inc
Nilfisk of America Inc
Rusmar Inc
Scientific Dust Collectors
Seghers Dinamec Inc
Spraying Systems Co
Terra Universal Inc
3M Co (Performance Chemicals)
United McGill Corp
Western Filter Co
Zurn Air Systems

Electrodes pH

ISI Innovative Sensors, Inc.
800-835-5474

Innovative Sensors Inc

Electrodes Specific/Ion

ISI Innovative Sensors, Inc.
800-835-5474

Innovative Sensors Inc

Electrostatic Precipitator

Air Quality Engineering Inc
Ambient Engineering Inc

C G S
516-467-1600

Clean Gas Systems Inc
Croll Reynolds Co Inc
Ducon Environmental Systems Inc
Durr Environmental Systems
Micro Air Air Cleaners by Metal-Fab Inc

Monsanto Enviro-Chem
314-275-5700

Monsanto Enviro-Chem Systems Inc
Progressive Equipment Corp
United Air Specialists Inc
United McGill Corp
Wheelabrator Clean Air Systems Inc
Wheelabrator Technologies Inc

Electrostatic Precipitator Supplies/Accessories

Air Quality Engineering Inc
Ambient Engineering Inc
Ducon Environmental Systems Inc
Micro Air Air Cleaners by Metal-Fab Inc
Progressive Equipment Corp
United McGill Corp
Wheelabrator Clean Air Systems Inc

Elevators

ABB Air Preheater Inc Ehsam Prods
Art's Manufacturing & Supply

Emergency Response Training Services

Clean Harbors Environmental
Services Inc

Enclosures, Structural

Comco Inc
Cor-Test/ATC Environmental Inc
Cura Inc
Dames & Moore
ELB & Associates Inc
ERM Group Inc
ESSC (Earth Systems & Solutions Corp)
Enercon Services Inc
Environmental Products & Services Inc
Environmental Resource Center
HMTRI Hazardous Material Handling &
Research Institute
Heritage Environmental Services Inc
ICF Kaiser International Inc
Kemper Risk Management Services
Mabbett & Associates Inc
Marine & Environmental Testing Inc
National Technical Information Service
Network Environmental
Systems Inc (NES)
Oklahoma State University Engineering
Extension
ROY F Weston Inc
SSOE Inc
Scott Lawson Group Inc, The
Slickbar Products Corp
TRC Environmental Corp
SEE AD ON PAGE 32
University of Illinois Institute of Labor &
Indus Relat
Valien Safety Supply Co
Waid & Associates

Emission Monitor Systems

MSI
608-825-2055

MSI/Mechanical Systems Inc

Employment Services

Texas State Technical College (TSTC)
Vamco Engineering Group

Enclosures, Instrument/Valve

Concrete Systems Inc
Cosysco Inc
Custom Switches
Jerman, Daniel L, Co
Parkline Inc
Plasti-Fab Inc
Progressive Equipment Corp
Tracom Inc
Zero Enclosures

Enclosures, Structural

American Sigma Inc
BRD Noise & Vibration Control Inc
C H Hanson Co, The
Camber Corp

CHEMGUARD
708-377-4800

Chemguard Corp, The
Durr Environmental Systems

EKTO
207-324-4427

EKTO Mfg Cor
Environmental Compliance Products
Exploration Products
SEE AD ON PAGE 71
Fabric Building Systems Inc
HEMCO Corp

HAZ-SAFE
Buildings by Design
412-842-2130

Haz-Safe Buildings Div of CID Assoc Inc
SEE AD ON PAGE 72, 94

JBI Spray Booths & Finishing Systems
Plasti-Fab Inc
RMJ Machinery Inc
Reef Industries Inc
Rubb Building Systems

Enclosures, Structural

Safety Storage Inc
SEE AD ON PAGE 39, 79
Bacharach Inc
Shields Environmental Corp
Spring Instant Structures Inc
United McGill Corp

Engine Test Equipment

Inc
Monarch Instrument
Spectronics Corp

Engineering Services

ABB Environmental Services Inc
Adrian Brown Consultants Inc
American Standards Testing Bureau Inc
Angul Environmental Systems Inc
August Mack Environmental Inc
Blasland Bouck & Lee Inc
Blymyer Engineers Inc
Braun Intertec Corp
Brown & Caldwell
Burns & McDonnell Waste Consultants Inc
CDM Federal Programs Corp
Century West Environmental Inc
Chester Environmental
Conatch Consulting Group Inc
Cura Inc
James & Moore
Delta Environmental Consultants Inc
ERM Group Inc
Eckenfelder Inc
Encon Services Inc
Environmental Dynamics Inc
Environmental Resource Center
Environmental Science & Engineering Inc
Foth & Van Dyke
GeoTrans Inc
Garaghty & Miller Inc a Heidmij Co
Global Technologies
Graef, Anhalt, Schloemer & Assoc. Inc
Grant Environmental
Groundwater & Environmental Svcs Inc
Groundwater Services Inc

Groundwater Technology Inc
H H Burkitt Project Mgmt Inc
HDR Engineering Inc
Haley & Aldrich Inc
Harding Lawson Associates
SEE AD ON PAGE 34

Hazen & Sawyer
Heritage Environmental Services Inc
Hubbell Roth & Clark Inc
ICF Kaiser International Inc
Integrated Environmental Solutions Inc
SEE AD ON PAGE 35, 87

K & B Design Inc
Killam Associates
Lockwood Greene Technologies Inc
M L E
Millennium Science & Engineering Inc
Morrison Knudsen Corp
NUCON Intl Inc
National Technical Systems
R E Wright Environmental Inc
RMT Inc
Raytheon Environmental Svcs/
Raytheon Engineers & Construction
Recon Environmental Corp
Roy F Weston Inc
S W Cole Engineering Inc
SSOE Inc
Seawall, James W
Shred-Tech
Strong Environmental Inc
Sverdrup Civic Inc
Sverdrup Environmental Inc
TRC Environmental Corp
SEE AD ON PAGE 32

Testwell Craig Laboratories Inc
U S Environmental Engineering Inc
Vanco Engineering Group
Vulcan Iron Works Inc
Waid & Associates
Walk, Haydel & Associates Inc
Walter Grossman & Assoc
Western Water Consultants Inc
Wheelerabrator Clean Water Inc - HPD Div

Engines

A & J MANAGEMENT RESOURCES, INC.
FLUID DRIVES DIVISION
215-393-7454

A & J Management Resources Inc
Deere Power Systems

gator pump, inc
800-735-9811

Gator Pump Inc
Remediation Service Intl

Environmental Audits

ABB Environmental Services Inc
Adironack Environmental Associates Inc
Adrian Brown Consultants Inc
Allied Environmental Consultants Inc
Allon Geoscience Inc
Ambient Engineering Inc
American Standards Testing Bureau Inc
August Mack Environmental Inc
Bennett & Associates Inc
Blasland Bouck & Lee Inc
Blymyer Engineers Inc
Bovar Environmental
Burns & McDonnell Waste
Consultants Inc
CDM Federal Programs Corp
Camp Dresser & McKee Inc
Capsule Environmental Engineering Inc
Century West Environmental Inc
Chester Environmental
Clean World Engineering Ltd
Comco Inc
Corbus A Div of CMS Inc
James & Moore
Delta Environmental Consultants Inc
Dyncorp Environmental Energy & Natl
Security Programs
ELB & Associates Inc

303-651-0550
EMCO
FLOWMETERS

EMS Environmental Monitor Service
ENSR
ERM Group Inc
ESSC (Earth Systems & Solutions Corp)
Eckenfelder Inc
Encon Services Inc
Ensolech Inc
Enviro-Assist Inc
Enviroair Consultants Inc
Environmental Assessment Association
Environmental Compliance Products
Environmental Dynamics Inc
Environmental Education Enterprises E3
Environmental Products & Services Inc
Environmental Profiles Inc
SEE AD ON PAGE 57, 94

Environmental Resource Center
Environmental Risk Information & Imaging
Services ERIIS
Environmental Safety Services
Environmental Science & Engineering Inc
Environmental Training Group Inc
Foth & Van Dyke
GeoTrans Inc
Garaghty & Miller Inc a Heidmij Co
Graef, Anhalt, Schloemer & Assoc Inc
Grant Environmental
Groundwater & Environmental Svr Inc
Groundwater Technology Inc
H H Burkitt Project Mgmt Inc
HDR Engineering Inc
Haley & Aldrich Inc
Harding Lawson Associates
SEE AD ON PAGE 34
HazWaste Technologies Corp
Hazardous Environmental Consultants Inc
Heritage Environmental Services Inc
High Plains Consortium Inc
Holzmacher McLeonard & Murrell PC
Hydro Group Inc
ICF Kaiser International Inc

Integrated Environmental Solutions Inc
SEE AD ON PAGE 35, 87

Jaca Corp
K & B Design Inc
Kemper Risk Management Services
Killam Associates
Lexicon Environmental Associates Inc
Mabbett & Associates Inc
Marine & Environmental Testing Inc
Metcalf & Eddy
Micro Analytical Laboratories Inc
National Chemical Science & Engineering Inc
Morrison Knudsen Corp
National Technical Systems
Network Environmental
Systems Inc (NES)
Pittsburgh Activated Carbon Services Inc
Pollution Research & Technology Inc
(PRT)
R E Wright Environmental Inc
RMT Inc
Radon Detection Systems Inc
Raytheon Environmental Svcs/
Raytheon Engineers & Construction
Recon Environmental Corp
Rollins Environmental Services
Roy F Weston Inc
SSOE Inc
STP Specialty Technical Publishers Inc
Scott Lawson Group Inc, The
Seawall, James W
Shields Environmental Corp
Sverdrup Environmental Inc
TRC Environmental Corp
SEE AD ON PAGE 32
Terra Consulting Group Inc
Terracon Environmental Inc
Testwell Craig Laboratories Inc
Traverse Group, The
Trinity Consultants Inc
United Sciences Inc
Vanco Engineering Group

Environmental Audits

PRODUCTS/SERVICES

Windows™
software

Tame the
Audit Monster

AUDIT
PROFILES™

- automate the audit process
- measure program performance

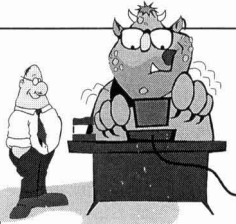

EP TRACKER™

- action tracking simplified
- standalone or integrate with AUDITProfiles™



Protocol Library

- EPA, OSHA regulations
- Special Programs—VPP, ISO, Management

1-800-EPI-6484

410•964•9900 ♦ 410•964•0008 FAX



ENVIRONMENTAL PROFILES, INC.

© 1995 All rights reserved



COOLEST FM DRIVE INS

APPROVED

- Protected Cradle and Crown™ 1/4" tubular steel skeleton, up to 4HR fire and 150 lb. ft² blast rated, down to -20° Fahrenheit, porcelain enameled steel interior, exceeds all codes.
- Haz-Safe-Mat Handling™ with up to 13'Wx8'H overhead rollup doors* for 3 pallets side by side and stacked 2 high. Optional crane hoist inside.
- 24" Grid Design System™ buildings up to 14'Wx70'L.
- Modular Building System™ for expansion, unlimited size.



HAZ-SAFE
Buildings by Design

a division of
CID Associates, Inc.
PH: (412) 842-2130
FAX: (412) 845-7834

P.O. Box 606
Leechburg, PA 15656-0606



* U.S. Patent 5,191,942,
5,285,617, 5,301,479,
5,396,742 Others Pending

Environmental Audits



Waid & Associates
Walk, Haydel & Associates Inc
Western Water Consultants Inc
Wonder Makers Inc

HazWaste Technologies Corp
Hazelclean Environmental Consultants Inc
Hazen & Sawyer
Heritage Environmental Services Inc
High Plains Consortium Inc
Holzmacher McLendon & Murrell PC
Hydro Group Inc
Hydro-Terra Inc
HydroGeoLogic Inc
ICF Kaiser International Inc
Integrated Environmental Solutions Inc
SEE AD ON PAGE 35, 87

Environmental Compliance Audits



Environmental Services Inc

Environmental Engineering

ABB Environmental Services Inc
Adirondack Environmental Associates Inc
Adrian Brown Consultants Inc
Advanced Air Technology Inc
Aeration Industries Intl Inc
Allied Environmental Consultants Inc
Allon Geoscience Inc
Ambient Engineering Inc
American Standards Testing Bureau Inc
Applied Utility Systems Inc
August Mack Environmental Inc
Blasiand Bouck & Lee Inc
Blymeyer Engineers Inc
Bovar Environmental
Braun Interfec Corp
Brown & Caldwell
Burns & McDonnell Waste Consultants Inc
CDM Federal Programs Corp



Camp Dresser & McKee Inc
Capsule Environmental Engineering Inc
Century West Environmental Inc
Chester Environmental
Clean Air Engineering
Clean World Engineering Ltd
Con-Test/ATC Environmental Inc
Cura Inc
DRE Technologies
Dames & Moore
Delta Environmental Consultants Inc
Ducor Environmental Systems Inc
Durr Environmental Systems
ELB & Associates Inc
ENSR



ERM Group Inc
ESSC (Earth Systems & Solutions Corp)
Eckenfelder Inc
Enercon Services Inc
EnsoTech Inc
Entropix Inc
Environmental Compliance Products
Environmental Dynamics Inc
Environmental Education Enterprises E3
Environmental Products & Services Inc
Environmental Resource Center
Environmental Restoration Systems
Environmental Science & Engineering Inc
Eppon Industrial Systems Inc
Export Technologies Inc
Foth & Van Dyke
GeoTrans Inc
Geraghty & Miller Inc a Heidmij Co
Graef, Anhalt, Schloemer & Associates Inc
Grant Environmental
Groundwater & Environmental Services Inc
Groundwater Services Inc
Groundwater Technology Inc
H H Burkitt Project Mgmt Inc
HDR Engineering Inc
Haley & Aldrich Inc
Harding Lawson Associates
SEE AD ON PAGE 34

Jaca Corp
Keating Environmental Management Inc
Kilam Associates
M L E
Mabbett & Associates Inc
Metcalf & Eddy
Millennium Science & Engineering Inc
Morrison Knudsen Corp
National Technical Systems
Pacific Environmental Services Inc
SEE AD ON PAGE 56, 88

Pollution Research & Technology Inc (PRT)
R E Wright Environmental Inc
RMT Inc
Raytheon Environmental Svcs/
Raytheon Engineers & Construction
Recon Environmental Corp
Rollins Environmental Services
Roy F Weston Inc
SSOE Inc
Sewall, James W
Sharp & Associates Inc
Shields Environmental Corp
Sverdrup Civic Inc
Sverdrup Environmental Inc
TRC Environmental Corp
SEE AD ON PAGE 32
Terracon Environmental Inc
Testwell Craig Laboratories Inc
Traverse Group, The
Trinity Consultants Inc
U S Environmental Engineering Inc
Ultra-Research Inc
Vamco Engineering Group
Vulcan Iron Works Inc



Waid & Associates
Walk, Haydel & Associates Inc
Western Water Consultants Inc
Wheelabrator Clean Air Systems Inc
Wheelabrator Technologies Inc
Wonder Makers Inc

Environmental Law

Bennett & Associates Inc
Blasiand Bouck & Lee Inc
Burns & McDonnell Waste Consultants Inc
Clark Boardman Callaghan
Enercon Services Inc
Envires Corp
Environmental Education Enterprises E3
Export Technologies Inc
ICF Kaiser International Inc
IHS Regulatory Products - EarthLaw
National Technical Information Service
R E Wright Environmental Inc
Rollins Environmental Services
Roy F Weston Inc
STP Specialty Technical Publishers Inc
Sharp & Associates Inc
Testwell Craig Laboratories Inc
Waid & Associates
Western Water Consultants Inc

Environmental Site Assessment

AAA Environmental
ABB Environmental Services Inc
Adirondack Environmental Associates Inc
Adrian Brown Consultants Inc
Airmetrics
Allied Environmental Consultants Inc
Allon Geoscience Inc
American Standards Testing Bureau Inc
Anguil Environmental Systems Inc
Arizona Instrument Corp
August Mack Environmental Inc

Bennett & Associates Inc
Blasiand Bouck & Lee Inc
Blymeyer Engineers Inc
Bovar Environmental
Braun Interfec Corp
Brown & Caldwell
CDM Federal Programs Corp
CTL Environmental Services



Camp Dresser & McKee Inc
Capsule Environmental Engineering Inc
Century West Environmental Inc
Chemetrics Inc
Chester Environmental
Clean Harbors Environmental Services Inc
Clean World Engineering Ltd
Comco Inc
Con-Test/ATC Environmental Inc
Cura Inc
Dames & Moore
Delta Environmental Consultants Inc
Durr Environmental Systems
Dyncorp Environmental Energy & Natl Security Programs
ELB & Associates Inc
ENSR
ERM Group Inc
ESSC (Earth Systems & Solutions Corp)
Eckenfelder Inc
Enercon Services Inc
EnsoTech Inc
Enviro-Map Inc
Enviroair Consultants Inc
Environmental Assessment Association
Environmental Compliance Products
Environmental Dynamics Inc
Environmental Education Enterprises E3
Environmental Products & Services Inc
Environmental Profiles Inc
SEE AD ON PAGE 57, 94

Environmental Resource Center
Environmental Risk Information & Imaging Services ERIIS
Environmental Safety Services
Environmental Science & Engineering Inc
Export Technologies Inc
Foth & Van Dyke
GeoTrans Inc
Geraghty & Miller Inc a Heidmij Co
Graef, Anhalt, Schloemer & Associates Inc
Grant Environmental



Groundwater & Environmental Services Inc
Groundwater Services Inc
Groundwater Technology Inc
H H Burkitt Project Mgmt Inc
HDR Engineering Inc
Haley & Aldrich Inc
Harding Lawson Associates
SEE AD ON PAGE 34
HazWaste Technologies Corp
Hazelclean Environmental Consultants Inc
Heritage Environmental Services Inc
High Plains Consortium Inc
Holzmacher McLendon & Murrell PC
Horsehead Resource Development Co Inc
Hydro Group Inc
Hydro-Terra Inc
HydroGeoLogic Inc
ICF Kaiser International Inc
Integrated Environmental Solutions Inc
Jaca Corp
Keating Environmental Management Inc
Kilam Associates
Kruck Environmental Services Inc
Lexicon Environmental Associates Inc
Mabbett & Associates Inc
Marine & Environmental Testing Inc
Metcalf & Eddy
Micro Analytical Laboratories Inc
Millennium Science & Engineering Inc
Morrison Knudsen Corp
National Technical Information Service
Network Environmental Systems Inc (NES)
Pacific Environmental Services Inc
SEE AD ON PAGE 56, 88
Pittsburgh Activated Carbon Services Inc

Pollution Research & Technology Inc (PRT)
R E Wright Environmental Inc
RMT Inc
Radon Detection Systems Inc
Raytheon Environmental Svcs/
Raytheon Engineers & Construction
Recon Environmental Corp
Rollins Environmental Services
Roy F Weston Inc
S W Cole Engineering Inc
SSOE Inc
STP Specialty Technical Publishers Inc
Scott Lawson Group Inc, The
Sensidyne Inc
Serengeti Environmental
Sewall, James W
Sharp & Associates Inc
Shields Environmental Corp
Site Assessment Software
Sverdrup Civic Inc
Sverdrup Environmental Inc
TRC Environmental Corp
SEE AD ON PAGE 32

Terra Consulting Group Inc
Terracon Environmental Inc
Testwell Craig Laboratories Inc



Tracer Research Corp
SEE AD ON PAGE 41
Traverse Group, The
U S Environmental Engineering Inc
Vamco Engineering Group
Vista Information Solutions Inc
SEE AD ON PAGE 8
Walk, Haydel & Associates Inc
Western Water Consultants Inc
Williams Environmental Services Inc
Wonder Makers Inc
Yamada Science & Art Corp (YSA)

Environmental Test Chambers

Air Toxics Ltd



Durr Environmental Systems
DynaVac
Groundwater & Environmental Services Inc
Industrial Filter & Pump Mfg Co
Lindberg
Mast/Keystone Inc
Omega Engineering Inc
SEE AD ON PAGE 2
Osmonics Inc
SEE AD ON PAGE 25
Terra Ultra Inc
Thermotron

Equipment Rental

ASC Professionals
Advanced Data Systems
Airmetrics
American Environmental Instruments Inc
Baker Tanks Inc
CAE Instrumental Rental
CVT America LLC
Calgon Carbon Corp
Carbonair Environmental Systems Inc
Clean Air Engineering
Coastal Leasing Inc
Colloid Environmental Technologies Co
Conti Environmental Inc
Diversified Well Products Inc
EnsoTech Inc
Enitech Instruments Inc
Environmental Recovery Resources Inc
Environmental Restoration Systems
Environmental Systems Engineering Inc

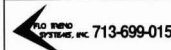

Flo Trend Systems Inc
SEE AD ON PAGE 64, 91
GeoGuard Inc
Global Technologies
Godwin Pumps of America Inc

Expansion Joints

Graseby
SEE AD ON PAGE 15, 89
Hazzo Services Inc
Health Consultants Inc
Instrumentation Northwest Inc (INW)
Intek Corp/Rent-Alyzer
Ionics Inc
Isco Inc Environmental Div
K-F Environmental Technologies Inc
Kack Instruments Inc
Ketrasonics Inc
Oiland Safety
Osmonics Inc
SEE AD ON PAGE 25

Pego Systems Inc
Portec C E D Environmental Products
R E Wright Environmental Inc
SSI Shredding Systems Inc
Scott Lawson Group Inc, The
Sebright Products
Universal Process Equipment Inc

Evaporation Equipment

APV Anhydro-Separation Technologies
Alfa Laval Thermal Inc
Aqua-Chem Inc
Bamebey & Sutcliffe Corp
Ben Meadows Co
Brinkmann Instruments Inc
Buck Scientific Inc
College Research Corp (CORECO)
Dedert Corp
EMC Equipment Manufacturing Corp
Epic Inc
International Reserve Equipment Corp
Labonco Corp
Landa Water Cleaning Systems
Met One Instruments Inc
SEE AD ON PAGE 43, 85



Niro Inc
Power Plant Services
Resources Conservation Co
Samsco Inc
SEE AD ON PAGE 101
Scientific Sales Inc
Seghers Dinamex Inc
Spraying Systems Co



Stord Inc
Swenson Process Equipment Inc
U S Environmental Engineering Inc
Universal Process Equipment Inc
Wheelabrator Clean Water Inc - HPD Div
Wheelabrator Clean Water Inc - Memtek Div

Excavating Service

Allon Geoscience Inc
Conti Environmental Inc
Cura Inc
Enercon Services Inc
EnsoTech Inc



Sevenson Environmental Services Inc
Soil Solutions Inc
Williams Environmental Services Inc

Expansion Joints

BRD Noise & Vibration Control Inc



General Rubber
JM Clipper Corp
Jerman, Daniel L Co
Pego Systems Inc
Precision Environmental International Inc
Proco Products Inc
Schuller International Inc

PRODUCTS/SERVICES

Explosion Vents

Bilco Co, The
Dustvent Inc
Fike Metal Products
Justine Manufacturing Co LLC
Mac Environmental
Pego Systems Inc

Fabric Filter

A&J Environmental Supply
Ambient Engineering Inc
Andersen 2000 Inc
C H Hanson Co, The
Ducon Environmental Systems Inc
Dustvent Inc
Filterspun
Gemstone Environmental
Griffin Environmental Co Inc
Hyde Products
M L E
Precision Environmental International Inc
RMJ Machinery Inc
Seghers Dinamex Inc
Serfilco Lts
3M Ceramic Fiber Products
United McGill Corp
Wheelabrator Clean Air Systems Inc
Zurn Air Systems

Fabricated Metal Products

A & J Management Resources Inc
Associated Design & Manufacturing Co
Bilco Co, The
Camber Corp
Goard Co

Halliday Products Inc
Highland Tank & Mfg Co
JBI Spray Booths & Finishing Systems
Mast/Keystone Inc
Monarch Separators Inc
NUCON Intl Inc
Seghers Dinamex Inc
Zero Enclosures

Fan Repair/Rebuilding

Abresist Corp
Meyer & Sons Inc, Wm W
Pego Systems Inc
Phelps Fan Inc
Zurn Air Systems

Fans

Air Plastics Inc
Andersen 2000 Inc
Bralstorf & Co Inc
Celcolate Air Pollution Control
Dual Div Met-Pro Corp

EG & G Rotron - Industrial Products Div
Hartzell Fan Inc
Kewaunee Scientific Corp
Meyer & Sons Inc, Wm W
Nederman Inc
New York Blower Co
Pego Systems Inc
Phelps Fan Inc
Spencer Turbine Co, The
Stanley Hydraulic Tools
Zurn Air Systems

Feeders

Acrison Inc
Capital Controls Co Inc
Cytac Industries Inc
FMI Fluid Metering Inc
General Kinematics Corp
Jeffrey/Indresco
Meyer & Sons Inc, Wm W
Or-Tec Inc
Pego Systems Inc
Portec C E D Environmental Products
Shred-Tech
Stiles-Kern Div Met-Pro Corp
Universal Engineering

Vac-U-Max
Vibra Screw Inc
Western Filter Co
Wysmont Co Inc

Feedwater Treatment Equipment

Alker-Murray Corp
American Technologies Group Inc
Capital Controls Co Inc
Chemetics Inc
Environmental Recovery Resources Inc
Hydro Group Inc
Ionics Inc
Kinetic Inc Engineered Systems Div
Mazzel Injector Corp
Osmonics Inc

SEE AD ON PAGE 25

Progressive Equipment Corp
Smith & Loveless Inc
U S Environmental Engineering Inc
Wheelabrator Clean Water Inc - HPD Div

Fiberglass Products

Air Plastics Inc
Ameron Fiberglass Pipe
Chemgrate Corp
Cosyco Inc
Enco EMC
Fibercast Co
Fyroc Div Met-Pro Corp
HEMCO Corp
Plastic Fusion Fabricators Inc
Plastronics Inc
Safeco Products Co
Schuller International Inc
Smith Fiberglass Products Inc
Tracom Inc
United Process Inc

Field Testing Instruments/Services

Adrian Brown Consultants Inc
Air Toxics Ltd
Airmetrics
American Environmental Instruments Inc
Aqua Tech Environmental Laboratories Inc (ATEL)
Argus Environmental Monitoring
August Mack Environmental Inc
Ben Meadows Co
BioNebraska Inc
Braun Intertec Corp
CEA Instruments Inc
CTL Environmental Services
Cura Inc
Enco EMC
Entech Instruments Inc
Entropy Inc
Enviro-Map Inc
GeoTrans Inc
Gilian Instruments

Hach Co
HazWaste Technologies Corp
Hazo Services Inc
Health Consultants Inc
Idelek Ino/Quantix Environmental
Instrumentation Northwest Inc (INW)
Kuck Environmental Services Inc
Mars Co
Metrosonics Inc
Millipore Corp
NUCON Intl Inc
OI Analytical
Omega Engineering Inc
SEE AD ON PAGE 2
Pittsburgh Activated Carbon Services Inc
Plastic Fusion Fabricators Inc
R E Wright Environmental Inc
Raytheon Environmental Svcs/
Raytheon Engineers & Construction
Rite in the Rain Fieldbooks
S W Cole Engineering Inc
Scott Lawson Group Inc, The
Sensidyne Inc

Seawall, James W
Sverdrup Environmental Inc
TRC Environmental Corp
SEE AD ON PAGE 32

Turner Designs Inc
SEE AD ON PAGE 21, 83
United Sciences Inc
Williams Environmental Services Inc

Filter Accessories

A & J Management Resources Inc
American Gas Products Inc
Associated Design & Manufacturing Co
Baldwin Environmental Inc
Bowerston Shale Co, The
Celle Co
Chemco Manufacturing Co Inc
Diversified Well Products Inc
Filterspun
Gemstone Environmental
Gilian Instruments

Graseby
SEE AD ON PAGE 15, 89

Hankison Intl
Harborlite Corp
Instrumentation Northwest Inc (INW)
Keystone Filter Div Met-Pro Corp
Kraissl Co Inc
Mellag Div Met-Pro Corp
Millipore Corp
Neoterik Health Technologies Inc
Parker Hannifin Corp
Progressive Equipment Corp
Schuller International Inc
Sethco Div Met-Pro Corp
Water Equipment Technologies Inc
Whalman Inc

Filter Presses

Alternative Remedial Technologies Inc
Andritz-Ruthner Inc
Associated Design & Manufacturing Co
Baier Equipment Co

Diagenex Inc
Durrion Co Inc
EIMCO Process Equipment
Envirex Inc
Filterspun

Flo Trend Systems Inc
SEE AD ON PAGE 64, 91

Frontier Technology Inc
Gemstone Environmental

HydroCal
Industrial Filter & Pump Mfg Co
International Reserve Equipment Corp
JWI
Larox Inc
Mid-Western Processes Inc
Netzsch Inc
Or-Tec Inc
Serfilco Lts

Sevenson Environmental Services Inc
Smith & Loveless Inc
Star Systems Filtration Div/Hilliard of
South Carolina
Universal Process Equipment Inc
Waste-Tech Inc
Wheelabrator Technologies Inc

Filtration Systems

A C Schuller of NJ, MD, & DE
AAF Intl
Advanced Containment Systems Inc
Allegro Industries
American Gas Products Inc
Angul Environmental Systems Inc
Applied Membranes Inc
Associated Design & Manufacturing Co
Baier Equipment Co
Barneby & Sulcliffe
Bird Machine Co Inc
CVM Corp
Calgon Carbon Corp
Carbon Activated
Carbtrol Corp
Chemco Manufacturing Co Inc
Culligan Intl
Davco Div Davis Water & Waste
Industries Inc
Durrion Co Inc
Dustvent Inc
EIMCO Process Equipment
Enmet Corp
Environmental Recovery Resources Inc
Environmental Systems Engineering Inc
Filterspun

Flo Trend Systems Inc
SEE AD ON PAGE 64, 91

Gemstone Environmental
General Carbon Corp
GeoPure Systems & Services
Geotech Environmental Equipment Inc
Great Lakes Environmental Inc
Hankison Intl
Hungerford & Terry Inc
Hyde Products
Hydro Group Inc
Industrial Filter & Pump Mfg Co
International Reserve Equipment Corp
Ionics Inc
JWI
Keystone Filter Div Met-Pro Corp
Kinetic Inc Engineered Systems Div
Kraissl Co Inc
La-Man Corp
Landa Water Cleaning Systems
Larox Inc
M L E
Mellag Div Met-Pro Corp
Met-Pro Corp Systems Div
Micro Air Air Cleaners by Metal-Fab Inc
Millipore Corp
NUCON Intl Inc
Neoterik Health Technologies Inc
Netzsch Inc
Northwestern Carbon
Oil Skimmers Inc
Osmonics Inc

SEE AD ON PAGE 25

Ozaci Inc
Pactec Inc
Parker Hannifin Corp
Progressive Equipment Corp
Prosys Corp
Prestream Inc
R P Adams Co Inc
RGF Environmental Systems Inc
Samsco Inc
SEE AD ON PAGE 101
Seghers Dinamex Inc
Serfilco Lts
Sethco Div Met-Pro Corp

Sevenson Environmental Services Inc
Smith & Loveless Inc
3M Filtration Products
Treatment Technologies
U S Environmental Engineering Inc
United States Filter Corp
Universal Process Equipment Inc
Water Equipment Technologies Inc
Western Filter Co
Whalman Inc
Whalman/Balston
Wheelabrator Clean Water Inc - HPD Div
Wheelabrator Clean Water Inc - Memtek
Div
Wheelabrator Technologies Inc
Zimpro Environmental Inc

Fire Safety Equipment

Bay Marketing

CEA Instruments Inc
Direct Safety Co
Hazo Services Inc
Jerman, Daniel L, Co
Magid Glove & Safety Mfg Co
National Technical Information Service
Oiland Safety
RKI Instruments Inc
Spraying Systems Co
Strong Environmental Inc
3M Co (Performance Chemicals)
Valien Safety Supply Co
Ziamatic Corp

Fittings

A & J Management Resources Inc
Alternative Remedial Technologies Inc
Asahi/America Inc
Chemtrol Div of Nibco Inc
Diversified Well Products Inc
Dow Plastic-Lined Piping Products
Eston Thermoplastics
Jerman, Daniel L, Co
Kewaunee Scientific Corp
Kraissl Co Inc
NewAge Industries Inc

Nibco Inc
OPW Fueling Components
Omega Engineering Inc
SEE AD ON PAGE 2

Pacer Pumps Div of ASM Industries Inc
Parker Hannifin Corp
Phillips Driscopipe
Plastic Fusion Fabricators Inc
Plexco
Scott Specialty Gases
Smith Fiberglass Products Inc
Spectra Gases Inc
Strong Environmental Inc

VICI Valco Instruments Co Inc

Flame Arrestors

New Pig Corp
SEE AD ON PAGE 49, 99
Pego Systems Inc
Spectra Gases Inc

Flash Point Tester

ELE Intl Inc/Solitest Products Div
HES Inc
Hazo Services Inc

Floating Baffles

Containment Systems
Cytac Industries Inc
Environetics Inc
Environmental Recovery Resources Inc
Plastic Fusion Fabricators Inc
Poly Processing Co
Slickbar Products Corp
Sunshine Technology Corp

Floats/Pontoons

Enviropack
Exploration Products
SEE AD ON PAGE 71
Liquid Waste Technology
SEE AD ON PAGE 65

Plastronics Inc
Solvay Interox

Flocculants

Chemical Lime Co
Colloid Environmental Technologies Co
Crown Technology Inc
Cytac Industries Inc
General Chemical Corp
Smith & Loveless Inc
Stockhausen Inc
W Canning Inc
Wyo-Ben Inc

Flotation Equipment

Flotation Equipment

Aeromix Systems Inc
 Davco Div Davis Water & Waste
 Industries Inc
 EIMCO Process Equipment
 Envirex Inc
 Enviropack
Exploration Products
 SEE AD ON PAGE 71
Flo Trend Systems Inc
 SEE AD ON PAGE 64, 91



800-735-9811
 Gator Pump Inc
 Grace Tec Systems
 Great Lakes Environmental Inc



800-877-0765
 HydroCal
 Manning Environmental Inc
 Or-Tec Inc
 Smith & Loveless Inc
 Tenco Hydro Inc
 Wolverine (Massachusetts) Corp

Flow Instrumentation

A P Buck Inc
 Advanced Data Systems
 American Sigma Inc
 Argus Environmental Monitoring



800-255-5008
 Auburn International Inc
 SEE AD ON PAGE 69

BIOS Intl Inc
 Badger Meter Inc
 Bailey Controls Co
 Ben Meadows Co
 Blue-White Industries
 Brooks Instrument
 Clean Air Engineering
 Coastal Environmental Systems
 Coastal Leasing Inc
 Control Electronics Inc
 Controlotron
 Custom Switches
 Drexelbrook Engineering Co
 Dwyer Instruments Inc
 Dynasonics Inc
 EIT
 EPG Companies
 Environs Inc
 Epic Inc
 Flow Instrumentation & Consulting
 Services Inc
 Fluid Components Intl
 Foxboro Co, The
 Gem Sensors Div
 George Fischer Inc



916-863-0804
 Global Water
 Great Lakes Instruments
 Gurley Precision Instruments



805-988-6800
 Harwil Corp
 ISTA Energy Systems Corp
 Instrumark International Inc
 Instrumentation Northwest Inc (IWW)
 Instruments Direct Inc
 Intek Corp/Rent-Allyzer
 Invalco Inc
 Iso Inc Environmental Div
 J L Rochester Co
 Jerman, Daniel L, Co
 Johnson Yokogawa Corp
 Kistele-Morse
 MKS Instruments Inc
 Mars Co
 Marsh-McBirney Inc



800-648-5778
 Mid-West Instrument
 Miltronics Inc
 Monitek Technologies Inc
 Northwest Environmental Services
 Testing & Training
Omega Engineering Inc
 SEE AD ON PAGE 2

Pace Transducer Div of
 CJ Instruments Inc
 Plast-O-Matic Valves Inc
 QED Environmental Systems Inc
 R D McMillan Co Inc
 SKC Inc
 Scott Specialty Gases
 SeaMetrics Inc
 Serfilco Lts
 Sparling Instruments Co Inc
 Specialty Mfg Co, The
 TheI-Mar Co



408-749-0994
 Turner Designs Inc
 SEE AD ON PAGE 21, 83
 Tylan General Inc
 Vallen Safety Supply Co



209-784-3544
 Water Specialties Corp

Flowmeters, Liquid, Gas & Steam

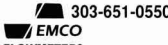

303-651-0550
 EMCO Flowmeters

Flowmeters, Low Volume



913-681-3913
 Challenge Environmental Systems Inc

Flowmeters, Mass

ABB K-Flow Inc
 Advanced Data Systems
 Badger Meter Inc
 Bailey Controls Co
 Brooks Instrument
 Controlotron



914-246-3401
 EG & G Rotron - Industrial Products Div
 Fluid Components Intl
 Foxboro Co, The
 Horiba Instruments Inc
 Invalco Inc
 Johnson Yokogawa Corp
 K-Tron America
 Lutz Pumps Inc
 MKS Instruments Inc
 Monitek Technologies Inc
Omega Engineering Inc
 SEE AD ON PAGE 2
 Pace Transducer Div of
 CJ Instruments Inc
 Peak Measurement
 R D McMillan Co Inc
 Restek Corp
 Scott Specialty Gases
 Specialty Mfg Co, The
 Tylan General Inc
 United Sciences Inc
 Vallen Safety Supply Co

Flowmeters, Variable Area

Advanced Data Systems
 Blue-White Industries
 Brooks Instrument
 Coastal Leasing Inc
 Dwyer Instruments Inc
 Fluid Components Intl
 G O Environmental Inc
 George Fischer Inc
 Hazzo Services Inc
 Marsh-McBirney Inc
 Monitek Technologies Inc
Omega Engineering Inc
 SEE AD ON PAGE 2
 Scott Specialty Gases
 Terra Universal Inc
 Vallen Safety Supply Co

Flue Gas Conditioning

Andersen 2000 Inc
 High Plains Consortium Inc



516-694-9555
 Misonix Inc
 United McGill Corp
 Wheelabrator Clean Air Systems Inc
 Zurn Air Systems

Flue Gas Desulfurization

Andersen 2000 Inc
 Aqua-Chem Inc
 Bird Machine Co Inc
 Calgon Carbon Corp
 Celcoite Air Pollution Control
 Chemical Lime Co
 Cheminer Inc



516-467-1600
 Clean Gas Systems Inc
 Coll Reynolds Co Inc
 Ducon Environmental Systems Inc
 High Plains Consortium Inc
 Misonix Inc
 Noell Inc
 Raytheon Environmental Svcs/
 Raytheon Engineers & Construction
 Sauereisen
 Spraying Systems Co
 United McGill Corp
 Wheelabrator Clean Air Systems Inc
 Zurn Air Systems

Flumes/Weirs

American Sigma Inc
 Environmental Recovery Resources Inc
 Global Water
 Instrumark International Inc
 Plasti-Fab Inc
 Plastronics Inc
 TheI-Mar Co
 Tracom Inc

Flushing/Cleaning Equipment

New Pig Corp
 SEE AD ON PAGE 49, 99
 RMJ Machinery Inc
 Safety-Kleen Corp
 W Canning Inc

Fly Ash Recovery/Treatment Systems

College Research Corp (CORECO)
 Conti Environmental Inc
 High Plains Consortium Inc
 International Reserve Equipment Corp
 Krebs Engineers Inc
 Pactec Inc



605-665-8770
 Portec C E D Environmental Products
 Raytheon Environmental Svcs/
 Raytheon Engineers & Construction
 W Canning Inc

Freeze Protection

Horizontal Technologies Inc
 W Canning Inc

FTIR Spectrometers



608-276-6100
 Nicolet Instrument Corp

Fume Exhaust System

ABB Air Preheater Inc
 SEE AD ON PAGE 81
 Air Plastics Inc
 Airex Corp
 Anguil Environmental Systems Inc
 August Mack Environmental Inc
 Celcoite Air Pollution Control



516-467-1600
 Clean Gas Systems Inc
 Duall Div Met-Pro Corp
 Ducon Environmental Systems Inc
 Dustvent Inc
 Goad Co
 HEMCO Corp
 Johnson Matthey
 K & B Design Inc
 Met-Pro Corp Systems Div
 Micro Air Air Cleaners by Metal-Fab Inc
 Misonix Inc
 Nederman Inc
 Nestlerik Health Technologies Inc
 Plastronics Inc
 Precision Environmental International Inc
 Spensor Turbine Co, The
 Terra Universal Inc
 United Air Specialists Inc
 United McGill Corp

Fume Hoods

Air Plastics Inc
 August Mack Environmental Inc
 Duall Div Met-Pro Corp
 Goad Co
 HEMCO Corp
 Kewaunee Scientific Corp
 L & L Process Industries Inc
 Labconco Corp
 Misonix Inc
 Myraid Industries
 Nederman Inc
 Plastronics Inc
 Precision Environmental International Inc
 Tegal Scientific Inc
 Terra Universal Inc
 United Air Specialists Inc
 United McGill Corp
 Winsor & Jerauld

Gas Chromatographs

American Environmental Instruments Inc
 American Scientific Instrumentation
 Argus Environmental Monitoring
 Buck Scientific Inc
 CDS Analytical Inc
 Celite Corp

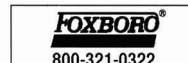

800-321-0322

Foxboro Co, The
 HNU Systems Inc
 Hazzo Services Inc
 Heath Consultants Inc
 Intek Corp/Rent-Allyzer
 OI Analytical
 Perkin-Elmer Corp
Photovac Monitoring Instruments
 SEE AD ON PAGE 51, 57
 R E Wright Environmental Inc
 SRI Instruments
 Sensidyne Inc
 Sentex Systems Inc
 Shimadzu Scientific Instruments Inc
 Testwell Craig Laboratories Inc
 Vallen Safety Supply Co

Gas Detectors

Gas Cooling Equipment

Baldwin Environmental Inc
 Misonix Inc
 NUCON Intl Inc
 Spraying Systems Co

Gas Detectors

AGA Gas Inc
 Advanced Data Systems
 Air Instruments & Measurements Inc
 Amer. Safety & Abatement Products Inc
 Anrad Inc
 Argus Environmental Monitoring
 Arizona Instrument Corp
 Assay Technology Inc
 Bacharach Inc
 Ben Meadows Co
 Biosystems Inc
 CEA Instruments Inc
 Capital Controls Co Inc
 Chem-Tex Corp
 Columbia Scientific



201-575-9114
 Control Instruments Corp
 Detecon Inc
 Direct Safety Co
 Dyna-FID Inc
 EIT
 Ecom America
 Emmet Corp



800-321-0322
 Foxboro Co, The



510-745-8700

Gas Tech Inc
 Gem Sensors Div
 Grace Industries Inc
 HNU Systems Inc
 Hazzo Services Inc
 Heath Consultants Inc
 Horiba Instruments Inc
 Industrial Scientific Corp
 Intek Corp/Rent-Allyzer
 International Sensor Technology
 Interscan Corp
 Jerman, Daniel L, Co
 Lumidor Safety Products
 MKS Instruments Inc
 Magid Glove & Safety Mfg Co
 Mast/Keystone Inc
 McNeill Intl
 Metrosonics Inc



408-293-5085

Mil-Ram Technology Inc
 Mico Safety Rental
 NUCON Intl Inc
 National Draeger Inc
 Olind Safety
Omega Engineering Inc
 SEE AD ON PAGE 2
Photovac Monitoring Instruments
 SEE AD ON PAGE 51, 57

RKI Instruments Inc
 Rae Systems Inc
 Restek Corp
 SCI-TEC Instruments Inc
 SKC Inc
 Scott Lawson Group Inc, The
 Scott Specialty Gases
 Sensidyne Inc
 Sensor Electronics Corp
 Servomex Co Inc
 Siemens Energy & Automation Inc
 Sierra Monitor Corp
 Solomat - Neotronics



800-932-0624
 Spectra Gases Inc

PRODUCTS/SERVICES

Gas Detectors



Spectrex Corp
Tracker Technologies Inc
Transducer Research Inc
U S Industrial Products Co Inc
VICI Metronics Inc
Vaisala Inc
Valen Safety Supply Co
Zellweger Analytics Inc

Gas Source/Supplies

AGA Gas Inc
AirSep Corp
Hazzo Services Inc



Praxair Inc
RKI Instruments Inc



Spectra Gases Inc
Whatman/Balston

Gas Storage Equipment

AGA Gas Inc
Brown-Minneapolis Tank
Entech Instruments Inc
Environmental Compliance Products
Mentor
Safety Storage Inc
SEE AD ON PAGE 39, 79
Shields Environmental Corp
Spectra Gases Inc
Total Containment

Gaskets/Packing/Seals

Basco Inc
JM Clipper Corp
John Crane Intl
Parker Hannifin Corp
Proco Products Inc

Generators



A & J Management Resources Inc
Environmental Systems Engineering Inc
Hazzo Services Inc
R E Wright Environmental Inc
Remediation Service Intl
Stanley Hydraulic Tools
Whitman Inc

Geographic Information Systems

Bovar Environmental
Camp Dresser & McKee Inc
Dames & Moore
ERM Grodp Inc
Environmental Education Enterprises E3
GeoTrans Inc
Geraghty & Miller Inc a Heidmij Co
Grant Environmental
Hazzo Services Inc
Holzmacher McLendon & Murrell PC
ICF Kaiser International Inc
Proud Data Service
Sewall, James W
StratFact Software
Terra Consulting Group Inc
Traverse Group, The

Geophysical Instruments

Coastal Leasing Inc
Environmental Science & Engineering Inc
Exploration Products
SEE AD ON PAGE 71
Geophysical Survey Systems Inc
Keck Instruments Inc
Magellan Systems Corp



Mount Sopris Instrument Co Inc
Novalyntx Corp
Pace Transducer Div of
CJ Instruments Inc
R E Wright Environmental Inc

Geotextiles

A&J Environmental Supply
American Shy & Abatement Products Inc
Atlantic Screen & Mfg
C H Hanson Co, The
Exploration Products
SEE AD ON PAGE 71
Fabrico Environmental Liners Inc
Hoechst Celanese Corp
National Seal Co
North American Green
Plastic Fusion Fabricators Inc
Rabrok Environmental Liners Inc
Reel Industries Inc
TENAX Corp

Glassware

American Shy & Abatement Products Inc
Associated Design & Manufacturing Co
Eagle-Picher/E S A T
Hazzo Services Inc
Myriad Industries
SKS Bottle & Packing Inc
Wheaton Science Products

Grit Handling Equipment

Dustent Inc
EIMCO Process Equipment
Envirex Inc

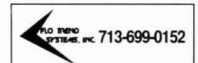

Flo Trend Systems Inc
SEE AD ON PAGE 64, 91

Hycor Corp
Rotobac
Smith & Loveless Inc
Walker Process Equipment Div of
McNish Corp

Groundwater Monitoring



Timco Manufacturing Inc

Groundwater Reclamation

AFL Industries Inc
Abanaki Corp Oil Skimmer Div
Adrian Brown Consultants Inc
Allied Environmental Consultants Inc
Alton Geoscience Inc
Andco Environmental Processes Inc
Atlantic Fluidics Inc
Atlantic Screen & Mfg
August Mack Environmental Inc
Bioscience Inc
Bovar Environmental
Burns & McDonnell Waste
Consultants Inc
Camp Dresser & McKee Inc
Delta Cooling Towers Inc

Groundwater Reclamation

Delta Environmental Consultants Inc
Durr Environmental Systems
ECO Purification Systems USA Inc
ERM Group Inc
ESSC (Earth Systems & Solutions Corp)
Eckenfelder Inc
Enco EMC
Enercon Services Inc
Ensolecth Inc

Environmental Education Enterprises E3
Environmental Products & Services Inc
Environmental Recovery Resources Inc
Environmental Systems Engineering Inc
GeoGuard Inc
Geraghty & Miller Inc a Heidmij Co
Grant Environmental
Groundwater Technology Inc
Heritage Environmental Services Inc
High Plains Consortium Inc
Horizontal Technologies Inc
Hudson Industries
IHS Regulatory Products - EarthLaw
Integrated Environmental Solutions Inc
SEE AD ON PAGE 35, 87

Keating Environmental Management Inc
Kinetic Inc Engineered Systems Div
Lexicon Environmental Associates Inc
Martin Marietta Magnesia Specialties Inc
Mazzei Injector Corp
Medina Agriculture Products Co Inc
Metcalf & Eddy
Millennium Science & Engineering Inc
Morrison Knudsen Corp
Northwestern Carbon
ORS Environmental Systems
Oil Skimmers Inc
R E Wright Environmental Inc
RMT Inc
Raytheon Environmental Svcs/
Raytheon Engineers & Construction
Remediation Inc
Roy F Weston Inc
Smith & Loveless Inc
Sverdrup Environmental Inc
Traverse Group, The

Does it seem like there is always something out there taking a bite out of your profits?

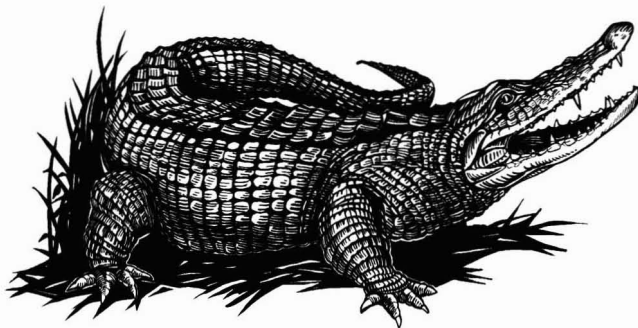

If you don't have coverage with the Fund, you might want to ask your agent to call this number—it's the Fund Information Line (800) 859-5995

The biggest bite can almost always be attributed to workplace accidents. Bite back—control your losses by working together with the loss prevention specialists at the **Texas Workers' Compensation Insurance Fund.**



Helping Build a Stronger Texas

Groundwater Reclamation

U S Environmental Engineering Inc
Water Equipment Technologies Inc
Western Water Consultants Inc
Wheelerator Technologies Inc

Groundwater Testing & Monitoring Equipment

A&J Environmental Supply
Advanced Control Systems Corp
Advanced Data Systems
Apar Corp Inc
Alton Geoscience Inc
American Environmental Instruments Inc



800-635-7330

Art's Manufacturing & Supply
Arthur Technology Inc
Associated Design & Manufacturing Co
Atlantic Screen & Mtg
Ben Meadows Co
Boat Longyear Co
Bovar Environmental
Burns & McDonnell Waste
Consultants Inc
Campbell Scientific Inc
Capital Controls Co Inc
Chemetics Inc
Computalog
Cura Inc
Dames & Moore
Dancer Communications Inc
Diversified Well Products Inc
Durr Environmental Systems
Enco EMC
Enercon Services Inc
Enviro Products Inc
Environmental Education Enterprises E3
Environmental Products & Services Inc
Environmental Science & Engineering Inc
Environmental Systems Engineering Inc

Epic Inc
FCI Environmental Inc
GeoGuard Inc
Geotech Environmental Equipment Inc
Global Water
Grundfos Pumps Corp
Hawk America Inc
Hazco Services Inc
Holzmacher McLondon & Murrell PC
Horiba Instruments Inc
Hydro Group Inc
In-Situ Inc

SEE AD ON PAGE 31

Instrumentation Northwest Inc (INW)
Intek Corp/Rent-Alyzer
Intervac
Ionics Inc
Kock Instruments Inc
Lexicon Environmental Associates Inc
Lexico Beach Inc



800-645-7339

MMC International Corp
SEE AD ON PAGE 24

Microbios Corp
Millipore Corp
Morrison Knudsen Corp



303-279-3211

Mount Sopris Instrument Co Inc
National Technical Information Service
ORS Environmental Systems
Omega Engineering Inc

SEE AD ON PAGE 2

Orbeco Analytical Systems Inc
Perkin-Elmer Corp
Phonetics Inc
Photovac Monitoring Instruments
SEE AD ON PAGE 51, 57

QED Environmental Systems Inc
R E Wright Environmental Inc
Raytheon Environmental Svcs/
Raytheon Engineers & Construction
Rescon Environmental Corp
Roy F Weston Inc
SERC Laboratories
SRI Instruments
Sensidyne Inc
Sharp & Associates Inc
Solomat - Neotronics
Spectronics Corp
TRC Environmental Corp

SEE AD ON PAGE 32



716-359-1110

Telog Instruments Inc
Testwell Craig Laboratories Inc



800-236-8534

Timco Manufacturing Inc
Tracer Research Corp
SEE AD ON PAGE 41



408-749-0994

Turner Designs Inc
SEE AD ON PAGE 21, 83
U S Industrial Products Co Inc
Zellweger Analytics Inc

Groundwater Treatment/Services

A C Schultes of NJ, MD, & DE
ABB Environmental Services Inc
Atrondack Environmental Associates Inc

Adrian Brown Consultants Inc
Allied Environmental Consultants Inc
Alton Geoscience Inc
Andco Environmental Processes Inc
August Mack Environmental Inc
Bioscience Inc
Blasland Bouck & Lee Inc
Blymyer Engineers Inc
Bovar Environmental
Braun Intertec Corp
CDM Federal Programs Corp
Calgon Carbon Corp
Cameron-Yakima Inc

CDM Camp Dresser & McKee Inc.
617-621-8181

Camp Dresser & McKee Inc
Carbtrol Corp
Century West Environmental Inc
Chemical Lime Co
Chester Environmental
Clean Harbors Environmental Sv Inc
Conti Environmental Inc
Cura Inc

DAMES & MOORE
213-683-0471

Dames & Moore
Delta Cooling Towers Inc
Delta Environmental Consultants Inc
Dual Div Met-Pro Corp
Durr Environmental Systems
ECO Purification Systems USA Inc
ERM Group Inc
ESSC (Earth Systems & Solutions Corp)
Earth Remediation Services Inc
Eckenfelder Inc
Enercon Services Inc
EnsoTech Inc
Environmental Education Enterprises E3
Environmental Products & Services Inc

Environmental Recovery Resources Inc
Environmental Restoration Systems
Environmental Science & Engineering Inc
Environmental Systems Engineering Inc
Environmental Tank Systems Inc (ETS)
Environmental Technical Services Inc
Foth & Van Dyke
General Carbon Corp
GeoPure Systems & Services
GeoTrans Inc
Geraghty & Miller Inc a Heidmij Co
Global Technologies
Grant Environmental
Great Lakes Environmental Inc

GES Groundwater & Environmental Services, Inc.
800-220-3068

Groundwater & Environmental Sv Inc
Groundwater Technology Inc
Haley & Aldrich Inc
Harding Loudon Associates
SEE AD ON PAGE 34

Hazclean Environmental Consultants Inc
Heritage Environmental Services Inc
Horizontal Technologies Inc
Hyde Products
Hydro Group Inc
Hydro-Terra Inc
HydroGeoLogic Inc
ICF Kaiser International Inc
Innovative Concepts Program
Integrated Environmental Solutions Inc
SEE AD ON PAGE 35, 87

Ionics Inc
Keating Environmental Management Inc
Killam Associates
Lexicon Environmental Associates Inc
Mabbett & Associates Inc
Martin Marietta Magnesia Specialties Inc
Maxmillian Technologies Inc
Met-Pro Corp Systems Div
Metcall & Eddy
Millennium Science & Engineering Inc

PRODUCTS/SERVICES

The LOGICAL Choice for Compliance

Environmental, Health & Safety Software

- Hazardous materials management
- Materials & waste tracking
- Compliance reporting

Regulatory Chemical Databases
MSDS Loading

1-800/COMPLY 1
E-Mail: logical@comply1.com
Fax: 309/689-2911

10th Anniversary

LOGICAL

TECHNOLOGY, INC.

We know how
[EARTH SHAKING]
a spill can be.

When the spill of the century hit the coast of Alaska, New Pig was there. We went because we could help. For over 10 years now, New Pig Corporation has been your partner in solving leak and spill problems. Some spills are unavoidable. Together we can make a difference. When spills are handled properly, the earth offers its undying thanks.

New Pig

1-800-HOT-HOGS®
(468-4647)

Groundwater Treatment/Services

Morrison Knudsen Corp
NUCOIN Intl Inc
National Technical Information Service
National Technical Systems
Northwest Environmental Services Training
& Training
Northwestern Carbon
Oil Skimmers Inc
Ozonology Inc
Pacific Environmental Services Inc
SEE AD ON PAGE 51, 88

Peoria Disposal Co
ProBios Inc
Progressive Equipment Corp
R E Wright Environmental Inc
RMT Inc
Raytheon Environmental Svcs/
Raytheon Engineers & Construction
Recon Environmental Corp
Regenesia Bioremediation Products
Remedial Systems Inc
Remediation Service Intl
Rollins Environmental Services
Roy F Weston Inc
S W Cole Engineering Inc
Samsco Inc
SEE AD ON PAGE 101

S **Sevenson Environmental Services, Inc.**
716-284-0431

Sevenson Environmental Services Inc
Sharp & Associates Inc
Smith & Lovelace Inc
Soil Solutions Inc
Sverdrup Environmental Inc
Testwell Craig Laboratories Inc
3M Filtration Products
Traverse Group, The
Treatment Technologies
U S Environmental Engineering Inc

800-323-8647

Unipure Environmental
United States Filter Corp
Vulcan Peroxidation Systems Inc
Western Filter Co
Western Water Consultants Inc
Wheelabrator Clean Air Systems Inc
Wheelabrator Clean Water Inc - HPD Div
Wheelabrator Technologies Inc
Zimpro Environmental Inc

Hazardous Material Handling

ABB Air Preheater Inc Raymond Prods
Allied Environmental Consultants Inc
Alton Geoscience Inc
Aramco
August Mack Environmental Inc
Basco Inc
Bovar Environmental
CDM Federal Programs Corp
Chem-Tainer Industries
Civacon
Clean Harbors Environmental Services Inc
Comco Inc
Containment Corp
DeMarco MAX VAC Corp
Dustvent Inc
Enercon Services Inc
Environmental Compliance Products
Environmental Products & Services Inc
Environmental Waste Technology Inc
Fabrico Environmental Liners Inc
Haz-Mat Containment Corp
Haz-Stor

SEE AD ON PAGE 45, 114

HazWaste Technologies Corp
Hazelcan Environmental Consultants Inc
Haztech Systems Inc
Heritage Environmental Services Inc
IHS Logistics Library
Justrite Manufacturing Co LLC
Mabbett & Associates Inc
Maxmillian Technologies Inc
National Draeger Inc
National Marker Co
National Technical Information Service
New Pig Corp
SEE AD ON PAGE 49, 99

North American Environmental Corp
Packaging Research & Design
Plastic Fusion Fabricators Inc
R E Wright Environmental Inc
RMT Inc
Rabro Environmental Liners Inc
Remco Products Corp
Remediation Inc
Rollins Environmental Services
S & G Enterprises Inc
Safe Environmental Storage
Safety Storage Inc
SEE AD ON PAGE 39, 79

S **Sevenson Environmental Services, Inc.**
716-284-0431

Sevenson Environmental Services Inc
Sharp & Associates Inc
Shields Environmental Corp
Skolnik Industries Inc
Soil Solutions Inc
Stanley Storage Systems
Superior Special Services Inc
Sverdrup Environmental Inc
Teledyne Brown Engineering -
Environmental Services

Terra Universal Inc
Testwell Craig Laboratories Inc
Transport Law Research Inc
Traverse Group, The
U S Best
U S Environmental Engineering Inc
University of Illinois Institute of
Labor & Indus Relat
Valien Safety Supply Co
Williams Environmental Services Inc

Hazardous Material/Waste

Allied Environmental Consultants Inc
Alton Geoscience Inc
Andersen 2000 Inc
Ashland Chemical Co
SEE AD ON PAGE 7

Bovar Environmental
CDM Federal Programs Corp
Chem-Tainer Industries
Clean Harbors Environmental Services Inc
Clean World Engineering Ltd
Compacting Technologies
DeMarco MAX VAC Corp
Ducon Environmental Systems Inc
ELB & Associates Inc
ESSC (Earth Systems & Solutions Corp)
Enercon Services Inc
Environmental Compliance Products
Environmental Products & Services Inc
Environmental Waste Technology Inc
Harding Lawson Associates
SEE AD ON PAGE 34

HazWaste Technologies Corp
Hazelcan Environmental Consultants Inc
Heritage Environmental Services Inc
Johnson & Associates Consulting
Justrite Manufacturing Co LLC
LWD Inc
Maxmillian Technologies Inc
National Technical Information Service
National Technical Systems
North American Environmental Corp
Northwest Environmental Services
Testing & Training
P W Stephens Contractors Inc
PND Corp
Peoria Disposal Co
R E Wright Environmental Inc
RMT Inc
Remediation Inc
Rollins Environmental Services
SSI Shredding Systems Inc
Safety-Kleen Corp
Samsco Inc
SEE AD ON PAGE 101

S **Sevenson Environmental Services, Inc.**
716-284-0431

Sevenson Environmental Services Inc
Sharp & Associates Inc
Shields Environmental Corp
Soil Solutions Inc
Stanley Storage Systems
Strong Environmental Inc
Superior Special Services Inc

SC **Surface Combustion**
800-537-8980

Surface Combustion Inc
Sverdrup Civic Inc
Sverdrup Environmental Inc
TNT Technology Co
Teledyne Brown Engineering -
Environmental Services
Testwell Craig Laboratories Inc
U S Environmental Engineering Inc
Vulcan Iron Works Inc
Williams Environmental Services Inc

Hazardous Waste Containers

Adirondack Environmental Associates Inc
Assmann Corp of America
Baker Tanks Inc
Basco Inc
C H Hanson Co, The
Camber Corp
Chem-Tainer Industries
Containment Corp
Direct Safety Co

EP Container Corp. 800-211-0311

EP Container Corp
Eagle-Picher/E S A T
Enercon Services Inc
Enpac Corp
Environmental Compliance Products
Environmental Containment Corp
Environmental Products & Services Inc
Environmental Products Inc
Environmental Tank Systems Inc (ETS)
Enviropack

HAZ-MAT CONTAINMENT CORPORATION
800-943-6510

Haz-Mat Containment Corp

HAZ-SAFE
Buildings by Design
412-842-2130

Haz-Safe Buildings Div of CID Assoc Inc
SEE AD ON PAGE 72, 94

Haz-Stor

SEE AD ON PAGE 45, 114

Industrial Glassware
Justrite Manufacturing
Justrite Manufacturing Co LLC
Magid Glove & Safety Mfg Co
Mayold Industries
New Pig Corp
SEE AD ON PAGE 49, 99

North American Environmental Corp
PND Corp
Pactec Inc
Plastic Fusion Fabricators Inc
Plastics Inc
Poly Processing Co
Polyfoam Packers Corp
Safe Environmental Storage
Safety Storage Inc
SEE AD ON PAGE 39, 79

Hazardous Waste Drum Labels

North American SOFTWARE
800-966-5678

North American Software Inc

Hazardous Waste/Mat Treatment, Storage, Disposal

Hazardous Waste Equipment

A&J Environmental Supply
ABB Air Preheater Inc Raymond Prods
American Gas Products Inc
Atlantic Screen & Mfg
Baker Tanks Inc
Basco Inc
Bergen Barrel & Drum Co
Chem-Tainer Industries
Compacting Technologies
Containment Systems
Enpac Corp
Environmental Compliance Products
Environmental Containment Corp
Environmental Products & Services Inc
Environmental Tank Systems Inc (ETS)
Goodway Technologies Corp
Haz-Mat Containment Corp
Haz-Stor

SEE AD ON PAGE 45, 114

Haztech Systems Inc
Intek Corp/Rent-Alyzer
International Reserve Equipment Corp
Justrite Manufacturing Co LLC
Katec Inc
L & L Process Industries Inc
Mitsui Machinery Distribution Inc
National Marker Co
New Pig Corp
SEE AD ON PAGE 49, 99

North American Environmental Corp
Orwak USA Inc
Plastics Inc
RMJ Machinery Inc
S & G Enterprises Inc
SRS Crafitali Inc
SRS Industrial Engineering Inc
SSI Shredding Systems Inc
Safe Environmental Storage
Safety Storage Inc
SEE AD ON PAGE 39, 79

Safety-Kleen Corp
Samsco Inc

SEE AD ON PAGE 48, 115

Satum Shredders Div of MAC Corp
Shields Environmental Corp
Shred-Tech
Stanley Storage Systems
Strong Environmental Inc
U S Environmental Engineering Inc
Universal Process Equipment Inc
Von Roll/WTI

SEE AD ON PAGE 48, 115

Hazardous Waste Handling

Ashland Chemical Co

SEE AD ON PAGE 7

August Mack Environmental Inc
Bovar Environmental
CDM Federal Programs Corp
Comco Inc
Earth Remediation Services Inc
Environmental Compliance Products
Environmental Products & Services Inc
Environmental Recovery Resources Inc
Environmental Waste Technology Inc
GeoTrans Inc
Hazelcan Environmental Consultants Inc
Heritage Environmental Services Inc
IHS Regulatory Products - EarthLaw
Justrite Manufacturing Co LLC
Katec Inc
Morrison Knudsen Corp
North American Environmental Corp
Plastic Fusion Fabricators Inc
RMT Inc
Remco Products Corp
Remediation Inc
Rollins Environmental Services
Safety Storage Inc
SEE AD ON PAGE 39, 79

Safety-Kleen Corp

S **Sevenson Environmental Services, Inc.**
716-284-0431

Sevenson Environmental Services Inc
Sharp & Associates Inc
Shields Environmental Corp
Skolnik Industries Inc
Soil Solutions Inc
Strong Environmental Inc
Superior Special Services Inc

Sverdrup Environmental Inc
Terra Universal Inc
U S Environmental Engineering Inc
University of Illinois Institute of
Labor & Indus Relat
Von Roll/WTI
SEE AD ON PAGE 48, 115

Williams Environmental Services Inc

Hazardous Waste/Mat Treatment, Storage, Disposal

Adirondack Environmental Associates Inc
Alternative Remedial Technologies Inc
August Mack Environmental Inc
Bioscience Inc
Bovar Environmental
Braun Interfac Corp
CDM Federal Programs Corp
CINC

SEE AD ON PAGE 25
Camber Corp

HEM GUARD
808-377-4800

Hemguard Corp, The
Chlor Lime Co
Clean Harbors Environmental Services Inc
Concrete Systems Inc

DYNECOL
313-571-7141

Dynecol Inc

SOFT
800-844-1400

E-Soft Inc
ECO Purification Systems USA Inc
Easi-Set Industries
Enercon Services Inc
Ensolect Inc
Environmental Compliance Products
Environmental Products & Services Inc
Environmental Science & Engineering Inc
Environmental Tank Systems Inc (ETS)
Environmental Waste Technology Inc
Fabric Building Systems Inc
Foth & Van Dyke
Geraghty & Miller Inc a Heidmij Co
Harding Lawson Associates
SEE AD ON PAGE 34

HAZ-MAT CONTAINMENT CORPORATION
800-943-6510

Haz-Mat Containment Corp

HAZ-SAFE
Buildings by Design
412-842-2130

Haz-Safe Buildings Div of CID Assoc Inc
SEE AD ON PAGE 72, 94

Haz-Stor

SEE AD ON PAGE 45, 114

Hazelcan Environmental Consultants Inc
Hertz Equipment Rental Corp
Horizontal Technologies Inc
IHS Regulatory Products - EarthLaw
Justrite Manufacturing Co LLC
LWD Inc
Lexicon Environmental Associates Inc
Magid Glove & Safety Mfg Co
Metcalf & Eddy
Millennium Science & Engineering Inc

MORRISON KNUDSEN CORPORATION
208-386-7150

Morrison Knudsen Corp
National Marker Co
National Technical Information Service
National Technical Systems
North American Environmental Corp
OnSite * Otsite Inc
Osprey Biotechnics
Peoria Disposal Co

SAMSCO Wastewater Evaporators

Partner with the Leader

Why the Leader? Why Samsco?

- *Wastewater Evaporation is Our Business*
- *Ten Years of Field Experience and Application Knowledge*
- *Time-tested Proven Track Record*
- *More than 1,000 Installations Worldwide*
- *Unmatched Regulatory Proficiency*
- *Performance and Results – Guaranteed*

Minimize Your Investment Risk – Work with the Evaporator Experts

Waste Stream Assessment

SAMSCO provides a complete functional analysis of each of your waste streams. This enables us to project the specific performance characteristics of your waste streams within the SAMSCO equipment.

Regulatory Proficiency

When it comes time to work with your state for permitting approval, SAMSCO is there. We can either provide regulatory consultation, and/or we can complete all required documentation for you.

Quality...No Compromises

SAMSCO understands what is asked of an evaporator.

The equipment must continuously concentrate complex chemicals under harsh, ever-changing conditions. This demands uncompromising attention to:

- Equipment design
- Materials of construction
- Components selection
- Process/safety control logic

Engineered to Perform Day-in, Day-out

Facility Planning

Start to finish, SAMSCO will help integrate the evaporation system into your plant's daily operations. Complete system design of your wastewater handling and specification of ancillary equipment is provided, yielding flexibility, low operating cost and minimal routine maintenance.

Flexibility for the Future

SAMSCO systems are not waste stream specific and can process several complex chemistries simultaneously. As production needs change, SAMSCO provides free waste analysis throughout the operating life of the evaporator.

SAMSCO's superiority of design and construction remain the standard by which all other evaporation systems should be compared. Your investment is protected with SAMSCO.

Optional Condenser for "Closed Loop" Water Recovery

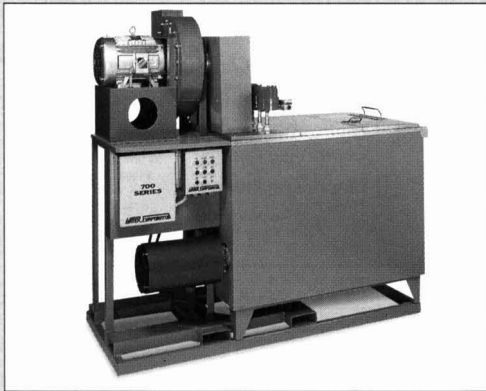

SYSTEM BENEFITS

- Reduce Wastewater Volume up to 98%
- Eliminate Sewer Accountability – Forever
- Process Multiple Waste Streams Simultaneously
- High Efficiency – Theoretically and Field Proven
- Lower Cost of Ownership
 - Operating Costs of Only Pennies per Gallon
 - Low Use and Maintenance Costs
- Simple to Install, Operate, and Maintain
- Fully Automatic – 24 Hour Unattended Use
- Redundant Safety/Operational Controls
- Natural Gas, Propane, Steam, and Electric Units
- Wide Range of Evaporative Capacities (Thousands to Millions of Gallons per Year)

Applications As Diverse As:

Machining & Grinding Coolants
Floor Scrubber & Mop Waters
Alkaline Cleaners & Parts Washing
Tumbling & Vibratory Solutions
Stamping & Drawing Compounds
RO/UF Concentrates & Flushes

Plating Solutions & Rinses
Die-Casting Process Waters
Ion-Exchange Regenerates
Vehicle & Aircraft Washing
Foods and Pharmaceuticals
Steam Cleaning & Power Wash

SAMSCO WATER EVAPORATOR

SAMSCO, INC., 18 Cote Avenue, Goffstown, New Hampshire 03045

Phone: (603)668-7111 Fax: (603)647-0537

THE RIGHT PUMP FOR THE JOB.

Selecting the right pump for your particular application can be difficult. Whatever your specifications, we have the right pump for the job.

Complete this form and fax it to us. Our experts will study your pumping requirements and provide an immediate recommendation based on the information you supply.

PLEASE CHECK THE PUMPS THAT YOU ARE INTERESTED IN.



SOLIDS AND CORROSIVE LIQUIDS

T and 10 Series pumps are designed for economical, trouble-free operation in handling solids, corrosive liquids and slurries.

Size: 1½" - 10" Max. Capacity: 3400 GPM
Max. Head: 130 Feet Max. Solids: 3"

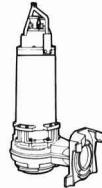

SUBMERSIBLE PUMPS

Stainless steel fitted and all stainless pump models are available for highly corrosive applications.

Size: 1½" to 12" Max. Capacity: 9500 GPM
Max. Head: 600 Feet Max. Solids: 5½"

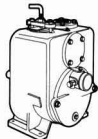

HIGH-EFFICIENCY SOLIDS AND CORROSIVE LIQUIDS

U Series pumps are the most efficient self-priming pumps available. Efficiencies up to 75%.

Size: 3", 4", 6" Max. Capacity: 1500 GPM
Max. Head: 207 Feet Max. Solids: 1¼"

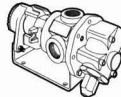

POSITIVE DISPLACEMENT

G Series rotary gear pumps can handle pressures up to 400 PSI.

Size: 1", 1½", 2", 2½", 3", 4" Max. Pressure (PSI): 400
Min. - Max. Capacity: 3-310 GPM
Viscosity (SSU): 250,000 Temp. °F: -60° to 675°



LIMITED SOLIDS, CORROSIVE AND CLEAR LIQUIDS

80 and O Series pumps are high-efficiency pumps designed for non-stop workloads. O Series pumps have a straight-in suction design which eliminates entrance restrictions and provides better suction performance when handling solvents and similar liquids.

Size: 1¼", 1½", 2", 3", 4", 6", 8" Max. Capacity: 2100 GPM
Max. Head: 400 Feet Max. Solids: 2½"

ADDITIONAL MODELS:

- Self-Priming Centrifugal Pumps
- Standard Centrifugal Pumps
- Engine-Driven, Self-Priming Centrifugal Pumps
- Diaphragm Pumps

**Tell Us
About Your
Specific
Application**

Name _____ Title _____

Company Name _____

Address _____

City _____ State _____ Zip _____

Phone Number _____ FAX Number _____

Liquid being pumped _____ Required GPM _____

Suction lift _____ Materials of construction _____

Discharge head _____

Additional Comments _____

GR
GORMAN-RUPP
PUMPS

The Gorman-Rupp Company

305 Bowman Street

Mansfield, OH 44901-1217

Phone: 419-755-1011 • Fax: 419-755-1251

©Copyright, The Gorman-Rupp Company, 1994

FAX: 419-755-1251

C-301 REV. 4/95

Fax to us for immediate analysis of your pumping application.

<http://www.gormanrupp.com> Circle 97 on card. grsales@gormanrupp.com

Hazardous Waste/Mat Treatment, Storage, Disposal

Plastic Fusion Fabricators Inc
ProBios Inc
RMT Inc
Ran for Rent
Remediation Inc
Rolling Environmental Services
S & G Enterprises Inc
Safe Environmental Storage
Safety Storage Inc
SEE AD ON PAGE 39, 79

 **800-323-5040**
Safety-Kleen Corp

 **Sevenson Environmental Services, Inc.**
716-284-0431

Sevenson Environmental Services Inc
Shields Environmental Corp
Skonik Industries Inc
Soil Solutions Inc
Sprung Instant Structures Inc
Stanley Storage Systems
Strong Environmental Inc
Superior Special Services Inc

 **Surface Combustion**
800-537-8980

Surface Combustion Inc
Sverdrup Civic Inc
TRC Environmental Corp
SEE AD ON PAGE 32
U S Environmental Engineering Inc
University of Illinois Institute of Labor & Indus Relat
Valen Safety Supply Co
Von Roll/WTI
SEE AD ON PAGE 48, 115
Vulcan Peroxidation Systems Inc
Williams Environmental Services Inc
Yamada Science & Art Corp (YSA)

Hazardous Waste Recycling

Alfa Laval Sharpies,
Alfa Laval Separation Inc
Alta Resource Mgmt Services Inc
American Pulverizer Co
Ashland Chemical Co
SEE AD ON PAGE 7
Bovar Environmental
CINC
SEE AD ON PAGE 25
ECO Purification Systems USA Inc
ELB & Associates Inc
ESSC (Earth Systems & Solutions Corp)
Environmental Compliance Products
Environmental Products & Services Inc
Environmental Waste Technology Inc
Harding Lawson Associates
SEE AD ON PAGE 34
Heritage Environmental Services Inc
IHS Regulatory Products - EarthLaw
Johnson & Associates Consulting
Katec Inc
Marine Shale Processors Inc
National Technical Information Service
National Technical Systems
North American Environmental Corp
PND Corp
RMT Inc
Rollins Environmental Services
SSI Shredding Systems Inc

 **MORRISON KNUDSEN CORPORATION**
208-386-7150

Hazardous Waste Services

Adrian Brown Consultants Inc
Allied Environmental Consultants Inc
Ashland Chemical Co
SEE AD ON PAGE 7
August Mack Environmental Inc
Blasland Bouck & Lee Inc
Bovar Environmental
Brown & Caldwell
CDM Federal Programs Corp

 **CDM** Camp Dresser & McKee Inc.
617-621-8181

Camp Dresser & McKee Inc
Century West Environmental Inc
Clean Harbors Environmental Services Inc
Comco Inc
Conti Environmental Inc
DRE Technologies

 **DAMES & MOORE**
213-683-0471

Dames & Moore
Delta Environmental Consultants Inc
ERM Group Inc
ESSC (Earth Systems & Solutions Corp)
Earth Remediation Services Inc
Emilcott-Idga Inc
Enseron Services Inc
EnsoTech Inc
Environmental Compliance Products
Environmental Products & Services Inc
Environmental Resource Center
Environmental Science & Engineering Inc
Environmental Waste Technology Inc
Foth & Van Dyke
GeoTrans Inc
Haley & Aldrich Inc
Harding Lawson Associates
SEE AD ON PAGE 34
HazWaste Technologies Corp
Hazelcan Environmental Consultants Inc
Heritage Environmental Services Inc
High Plains Consortium Inc
Hydro-Terra Inc
HydroGeologic Inc
Integrated Environmental Solutions Inc
SEE AD ON PAGE 35, 87
Kilam Associates
LWD Inc
Marine Shale Processors Inc
Maymillian Systems Inc
Metcall & Eddy
Millennium Science & Engineering Inc

 **MORRISON KNUDSEN CORPORATION**
208-386-7150

Morrison Knudsen Corp
National Technical Systems
North American Environmental Corp
PND Corp
Pacific Environmental Services Inc
SEE AD ON PAGE 56, 88
Peoria Disposal Co
R E Wright Environmental Inc
RMT Inc
Raytheon Environmental Svcs/
Raytheon Engineers & Construction
Remediation Inc
Rollins Environmental Services

 **MORRISON KNUDSEN CORPORATION**
208-386-7150

Morrison Knudsen Corp
National Technical Systems
North American Environmental Corp
PND Corp
Pacific Environmental Services Inc
SEE AD ON PAGE 56, 88
Peoria Disposal Co
R E Wright Environmental Inc
RMT Inc
Raytheon Environmental Svcs/
Raytheon Engineers & Construction
Remediation Inc
Rollins Environmental Services

 **800-323-5040**
Safety-Kleen Corp

 **Sevenson Environmental Services, Inc.**
716-284-0431

Sevenson Environmental Services Inc
Sharp & Associates Inc
Shields Environmental Corp
Soil Solutions Inc
Strong Environmental Inc
Superior Special Services Inc
Sverdrup Civic Inc

TRC Environmental Corp
SEE AD ON PAGE 32
Teledyne Brown Engineering - Environmental Services

 **TENEREX CORP.**
713-482-5801

Tenerex Corp
Traverse Group, The
U S Environmental Engineering Inc
Von Roll/WTI
SEE AD ON PAGE 48, 115

 **Waid and Associates**
512-255-9999

Waid & Associates
Williams Environmental Services Inc

Hazardous Waste Transportation

Ashland Chemical Co
SEE AD ON PAGE 7
Clean Harbors Environmental Srv Inc

 **DYNECOL**
313-571-7141

Dynecol Inc
E-SOFT
800-844-1400

E-Soft Inc
Environmental Compliance Products
Environmental Products & Services Inc
Environmental Tank Systems Inc (ETS)
Environmental Waste Technology Inc
Heritage Environmental Services Inc
IHS Logistics Library
Marine Shale Processors Inc
Morrison Knudsen Corp
North American Environmental Corp
Peoria Disposal Co
RMT Inc
Rollins Environmental Services
Safety-Kleen Corp

 **Sevenson Environmental Services, Inc.**
716-284-0431

Sevenson Environmental Services Inc
Sharp & Associates Inc
Shields Environmental Corp
Soil Solutions Inc
Strong Environmental Inc
Superior Special Services Inc
Teledyne Brown Engineering - Environmental Services
U S Environmental Engineering Inc

Hazmat Waste Dump & Roll-Off Trailers

 **CLEMENT**
318-377-2776

Clements Associates Inc

Heat Exchangers

 **A & J MANAGEMENT RESOURCES, INC.**
FLUID DRIVES DIVISION
215-393-7454

A & J Management Resources Inc
ABB Air Preheater Inc
SEE AD ON PAGE 81
APV Heat Transfer Technologies
Airex Corp
Alfa Lava Thermal Inc
Angul Environmental Systems Inc
Baldwin Environmental Inc
Chemineer Inc
Durr Environmental Systems
Edwards Engineering Corp
Envirex Inc
Epon Industrial Systems Inc

George Fischer Inc
Global Technologies
International Reserve Equipment Corp
John Crane Intl
L & L Process Industries Inc
R P Adams Co Inc
United Air Specialists Inc
Universal Process Equipment Inc
Walker Process Equipment
Div of McNish Corp
Wheelabrator Clean Water Inc - HPD Div
Xchanger Inc

Heat Recovery Systems

ABB Air Preheater Inc
SEE AD ON PAGE 81
APV Heat Transfer Technologies
Adwest Technologies Inc
Angul Environmental Systems Inc
Aqua-Chem Inc
CVM Corp
Durr Environmental Systems
Epon Industrial Systems Inc
Glenro Inc
John Zink Co Div Koch Engineering Co
L & L Process Industries Inc
Remediation Service Intl
United Air Specialists Inc
Universal Process Equipment Inc
Wheelabrator Clean Water Inc - HPD Div
Winsor & Jerard

Heating Cable/Tape

Glas-Col
Omega Engineering Inc
SEE AD ON PAGE 2
Technical Heaters Inc

Heavy Metal Detectors

BioNebraska Inc

Horizontal Boring Guidance System

 **METROTECH**
408-734-1400

Metrotech Corp

Hose/Tubing

A & J Management Resources Inc
Acutech Plastics Inc
Art's Manufacturing & Supply
Atlantic Screen & Mfg
Environmental Restoration Systems

 **GATOR PUMP, INC.**
800-735-9811

Gator Pump Inc
Godwin Pumps of America Inc
Hazzo Services Inc
Intek Corp/Rent-Alyzer
NewAge Industries Inc
Parker Hannifin Corp
QED Environmental Systems Inc
Spencer Turbine Co, The
Swagelok Companies, The
Thermoplastic Processes Inc

Hot Air Steam Stripping

 **Sevenson Environmental Services, Inc.**
716-284-0431

Sevenson Environmental Services Inc

Humidity Instrumentation

Air Instruments & Measurements Inc
Applied Technologies Inc
Argus Environmental Monitoring
Bacharach Inc
Ben Meadows Co
Campbell Scientific Inc
Climatronics Corp
SEE AD ON PAGE 110
Coastal Environmental Systems

Hydrocarbon Detectors

Coastal Leasing Inc
Entech Instruments Inc
Epic Inc
Handar
Hazzo Services Inc
Metronics Inc
Misonix Inc
Monarch Instrument
Novalyx Corp
Onset Computer Corp
Paco Transducer Inc
CJ Instruments Inc
Scientific Sales Inc
Solomat - Neotronics
Testo Inc
SEE AD ON PAGE 72
Vaisala Inc

Hydraulic Components Systems & Rebuilding Service

 **A & J MANAGEMENT RESOURCES, INC.**
FLUID DRIVES DIVISION
215-393-7454

A & J Management Resources Inc

Hydrocarbon Detectors

Air Instruments & Measurements Inc
American Environmental Instruments Inc
American City & Abatement Products Inc
Anarad Inc
Argus Environmental Monitoring

 **AS**
800-635-7330

Art's Manufacturing & Supply
Atlantic Screen & Mfg
Baldwin Environmental Inc
Ben Meadows Co
CEA Instruments Inc
California Analytical Instruments Inc
Clean Air Engineering
Control Instruments Corp
Dasibi Environmental Corp
Detcon Inc
Dival Safety Equipment
Dyna-FID Inc
Ecom America
Enmet Corp
Environmental Recovery Resources Inc
Environmental Systems Engineering Inc
FCI Environmental Inc

 **FOXBORO**
800-321-0322

Foxboro Co, The
Gas Tech Inc
Graze Industries Inc
Hazzo Services Inc
Health Consultants Inc
Highland Tank & Mfg Co
Horiba Instruments Inc
Industrial Scientific Corp
Inficon Inc
SEE AD ON PAGE 117, 164
Intek Corp/Rent-Alyzer
International Sensor Technology
Keck Instruments Inc
Lumidor Safety Products

 **MMC**
800-645-7339

MMC International Corp
SEE AD ON PAGE 24
McNeill Intl
Mil-Ram Technology Inc
Photovac Monitoring Instruments
SEE AD ON PAGE 51, 57
RKI Instruments Inc
Rae Systems Inc
SCI-TEC Instruments Inc
SKC Inc
SRI Instruments
Sensidyne Inc
Sensor Electronics Corp
Siemens Energy & Automation Inc
Sierra Monitor Corp
Spectra Gases Inc

PRODUCTS/SERVICES

Hydrocarbon Detectors

Spectrogram Corp
Spectronics Corp
Tracer Research Corp
SEE AD ON PAGE 41
Transducer Research Inc



Turner Designs Inc
SEE AD ON PAGE 21, 83
U S Industrial Products Co Inc
Vallen Safety Supply Co
Veeder-Root Co

Hydrogen Sulfide Control

CVT America LLC
Celco Air Pollution Control
Crown Technology Inc
Davis Process Div
General Carbon Corp
Mazzei Injector Corp
Misonix Inc
Osprey Biotechnics
Ozact Inc
Probiotic Solutions
RJ Environmental Inc
Radon Detection Systems Inc



Unisorb Corp
Vulcan Peroxidation Systems Inc
Water Equipment Technologies Inc
Wheelabrator Clean Air Systems Inc

Hydrogen Sulfide Detectors

Advanced Pollution Instrumentation Inc
Air Instruments & Measurements Inc
American Environmental Instruments Inc
Anarad Inc
Argus Environmental Monitoring
Arizona Instrument Corp
Bacharach Inc
Biosystems Inc
CEA Instruments Inc
Chemetrics Inc



Control Instruments Corporation
SEE AD ON PAGE 1114
Control Instruments Corp
Dasibi Environmental Corp
Del Mar Scientific Inc
Detcon Inc
Dival Safety Equipment
EIT
Energy Efficiency Systems Inc
Enmet Corp
Gas Tech Inc
Hazzo Services Inc
Health Consultants Inc
Industrial Scientific Corp
Intek Corp/Rent-Alyzer
International Sensor Technology
Lumidor Safety Products
McNeill Int'l
Metrotronics Inc



Mil-Ram Technology Inc
Myriad Industries



NuTech Environmental Corp
RKI Instruments Inc
SKC Inc
Scott Lawson Group Inc, The
Sensidyne Inc
Sensor Electronics Corp
Senovem Co Inc
Sierra Monitor Corp
Spectra Gases Inc
U S Industrial Products Co Inc
VICI Metrotronics Inc

Vallen Safety Supply Co
Zellweger Analytics Inc

Hydrological Equipment

American Environmental Instruments Inc
Ben Meadows Co
Campbell Scientific Inc
Coastal Environmental Systems
Coastal Leasing Inc
Global Water
Gurdy Precision Instruments
Hansar



Northwest Environmental Services
Testing & Training
Novalyx Corp
Rite in the Rain Fieldbooks

Identification Systems

Brady USA Inc Signmark Div
Diagraph Corp
Marking Services Inc
National Marker Co
Seton Identification Products
Tracker Technologies Inc

Incineration Systems

ABB Air Preheater Inc
SEE AD ON PAGE 81

Airex Corp
Andersen 2000 Inc
Angul Environmental Systems Inc
Bovar Environmental
CVM Corp
Cameron Environmental Inc
College Research Corp (CORECO)
Ducon Environmental Systems Inc



Durr Environmental Systems
EPG Companies



Engelhard Corp
Environmental Products & Services Inc
Environmental Systems Engineering Inc
Epon Industrial Systems Inc
Feco Engineered Systems Ltd
Grace Tec Systems



Hankin Environmental Systems Inc
L & L Process Industries Inc
MMT Environmental Services Inc
Maxymilian Technologies Inc
Met-Pro Corp Systems Div



Monsanto Enviro-Chem Systems Inc
Morrison Knudsen Corp

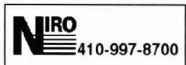

Niro Inc
Noell Inc



Parsons Combustion Corporation
Prototech Co, The
R E Wright Environmental Inc
Raytheon Environmental Svcs/
Raytheon Engineers & Construction
Remedial Systems Inc
Roy F Weston Inc
Seghers Dinamex Inc

Horizontal Boring Guidance System



Metrotech Corp



Surface Combustion Inc
Universal Process Equipment Inc
Vulcan Iron Works Inc
Wheelabrator Clean Air Systems Inc
Winsor & Jerauld
Zimpro Environmental Inc

Indoor Air Quality

A P Buck Inc
AAF Int'l
Air Quality Engineering Inc
Allied Environmental Consultants Inc
Aramco
Argus Environmental Monitoring
August Mack Environmental Inc
Blastand Bouck & Lee Inc
Blymyer Engineers Inc
Bovar Environmental
CEA Instruments Inc
CTL Environmental Services
Clean World Engineering Ltd
Con-Test/ATC Environmental Inc
Delta Environmental Consultants Inc
ELB & Associates Inc
ERM Group Inc
Emiloct Associates
Emiloct-dga Inc
Environmental Products & Services Inc
Environmental Science & Engineering Inc
Foth & Van Dyke

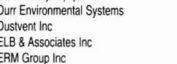

Foxboro Co, The
General Carbon Corp
Graseby

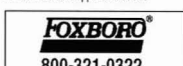

Foxboro Co, The
General Carbon Corp
Graseby

SEE AD ON PAGE 15, 89
Harding Lawson Associates

SEE AD ON PAGE 34
Hazzo Clean Environmental Consultants Inc
Hazzo Services Inc
Holzmacher McLendon & Murrell PC
Inchcape Testing Services/Environmental Laboratories
Intek Corp/Rent-Alyzer
International Sensor Technology
Jaca Corp
KVA/Analcat
Kilam Associates
Mabbett & Associates Inc
Marine & Environmental Testing Inc
McNeill Int'l
Metrotronics Inc
Misonix Inc
National Technical Information Service
Nederman Inc
Novalyx Corp
Occupational Health & Hygiene Corp of America

Pacific Environmental Services Inc
SEE AD ON PAGE 56, 88
Performance Analytical Inc
Pollution Research & Technology Inc (PRT)

R E Wright Environmental Inc
RMT Inc
Raytheon Environmental Svcs/
Raytheon Engineers & Construction
Roy F Weston Inc
SSOE Inc
Scott Lawson Group Inc, The
Sensidyne Inc
Sharp & Associates Inc
Superior Industrial Maintenance Co Inc
Sverdrup Environmental Inc
TRC Environmental Corp

SEE AD ON PAGE 56, 88
Transducer Research Inc
Traverse Group, The
Ultra-Research Inc
Vallen Safety Supply Co
Vanco Engineering Group
Wclair Inc
Wonder Makers Inc

SEE AD ON PAGE 64, 91
Raytheon Engineers & Construction
Roy F Weston Inc
SKC Inc
SSOE Inc
Scott Lawson Group Inc, The
Sensidyne Inc
Sierra Monitor Corp
Solomat - Neotronics

SEE AD ON PAGE 64, 91
Raytheon Engineers & Construction
Roy F Weston Inc
SKC Inc
SSOE Inc
Scott Lawson Group Inc, The
Sensidyne Inc
Sierra Monitor Corp
Solomat - Neotronics

SEE AD ON PAGE 64, 91
Raytheon Engineers & Construction
Roy F Weston Inc
SKC Inc
SSOE Inc
Scott Lawson Group Inc, The
Sensidyne Inc
Sierra Monitor Corp
Solomat - Neotronics

TRC Environmental Corp

SEE AD ON PAGE 32
Terra Universal Inc
Testo Inc

SEE AD ON PAGE 72
Testwell Craig Laboratories Inc
Transducer Research Inc
Vaisala Inc
Vallen Safety Supply Co
Vanco Engineering Group
Wonder Makers Inc
Worldwide Technology Inc

Industrial Hygiene

A P Buck Inc
ABB Environmental Services Inc



AGX Inc
Allied Environmental Consultants Inc
American Environmental Instruments Inc
Argus Environmental Monitoring
August Mack Environmental Inc
Blastand Bouck & Lee Inc
Blymyer Engineers Inc
Bovar Environmental
CEA Instruments Inc
CTL Environmental Services
Clean World Engineering Ltd
Con-Test/ATC Environmental Inc
Delta Environmental Consultants Inc
ELB & Associates Inc
ERM Group Inc
Emiloct Associates
Emiloct-dga Inc
Environmental Products & Services Inc
Environmental Science & Engineering Inc
Foth & Van Dyke



GRC Int'l Inc/Flow Gemini Systems
GTS Duratek
Graseby

SEE AD ON PAGE 15, 89
Harding Lawson Associates

SEE AD ON PAGE 34
Hazzo Clean Environmental Consultants Inc
Inchcape Testing Services/Environmental Laboratories
Industrial Scientific Corp
Intek Corp/Rent-Alyzer
Jaca Corp
Kilam Associates
Mabbett & Associates Inc
Magid Glove & Safety Mfg Co
Marine & Environmental Testing Inc
Metrotronics Inc
Micro Analytical Laboratories Inc
Occupational Health & Hygiene Corp of America
Pace Inc

Pacific Environmental Services Inc
SEE AD ON PAGE 56, 88

R E Wright Environmental Inc
RMT Inc
Raytheon Environmental Svcs/
Raytheon Engineers & Construction
Roy F Weston Inc
SSOE Inc
Scott Lawson Group Inc, The
Sensidyne Inc
Sharp & Associates Inc
Superior Industrial Maintenance Co Inc
Sverdrup Environmental Inc
TRC Environmental Corp

SEE AD ON PAGE 56, 88
Transducer Research Inc
Traverse Group, The
Ultra-Research Inc
Vallen Safety Supply Co
Vanco Engineering Group
Wclair Inc
Wonder Makers Inc

SEE AD ON PAGE 64, 91
Raytheon Engineers & Construction
Roy F Weston Inc
SKC Inc
SSOE Inc
Scott Lawson Group Inc, The
Sensidyne Inc
Sierra Monitor Corp
Solomat - Neotronics

SEE AD ON PAGE 64, 91
Raytheon Engineers & Construction
Roy F Weston Inc
SKC Inc
SSOE Inc
Scott Lawson Group Inc, The
Sensidyne Inc
Sierra Monitor Corp
Solomat - Neotronics

SEE AD ON PAGE 64, 91
Raytheon Engineers & Construction
Roy F Weston Inc
SKC Inc
SSOE Inc
Scott Lawson Group Inc, The
Sensidyne Inc
Sierra Monitor Corp
Solomat - Neotronics

SEE AD ON PAGE 64, 91
Raytheon Engineers & Construction
Roy F Weston Inc
SKC Inc
SSOE Inc
Scott Lawson Group Inc, The
Sensidyne Inc
Sierra Monitor Corp
Solomat - Neotronics

SEE AD ON PAGE 64, 91
Raytheon Engineers & Construction
Roy F Weston Inc
SKC Inc
SSOE Inc
Scott Lawson Group Inc, The
Sensidyne Inc
Sierra Monitor Corp
Solomat - Neotronics

SEE AD ON PAGE 64, 91
Raytheon Engineers & Construction
Roy F Weston Inc
SKC Inc
SSOE Inc
Scott Lawson Group Inc, The
Sensidyne Inc
Sierra Monitor Corp
Solomat - Neotronics

Insurance

International Reserve Equipment Corp
Vallen Safety Supply Co
Walker Process Equipment Div of
McNish Corp

Instrument Accessories

APV Anhydro-Separation Technologies
APV Heat Transfer Technologies
American Safety & Abatement Products Inc
BTR Instruments
Buck Scientific Inc
Crompton Instruments NA
Custom Switches
Enmet Corp
Entech Instruments Inc
Hawk America Inc
Hazzo Services Inc
Instrumentation Northwest Inc (INW)
Intek Corp/Rent-Alyzer
Met One Instruments Inc
SEE AD ON PAGE 43, 85

Metrotronics Inc
OI Analytical
Restek Corp
Rosemount Analytical Inc
SeaMetrics Inc
Sierra Monitor Corp
Structure Probe Inc/SPI Supplies
Vallen Safety Supply Co
Zero Enclosures

Instrument Rental

Advanced Data Systems
Airmetrics
American Environmental Instruments Inc
CAE Instrumental Rental
Clean Air Engineering
Coastal Leasing Inc
Controlotron
Dival Safety Equipment
Dyna-FID Inc
Energy Efficiency Systems Inc
Entech Instruments Inc
Environics Inc
Flow Instrumentation & Consulting Services Inc
GTS Duratek
Geotech Environmental Equipment Inc
Hazzo Services Inc
Industrial Scientific Corp
Instrumentation Northwest Inc (INW)
Intek Corp/Rent-Alyzer
Keck Instruments Inc
Manning Environmental Inc
Met One Instruments Inc
SEE AD ON PAGE 43, 85

Metrotronics Inc
OI Analytical
Oiland Safety
Pace Transducer Div of
CJ Instruments Inc
R E Wright Environmental Inc
SRI Instruments
Scott Lawson Group Inc, The

SEE AD ON PAGE 43, 85
Manning Environmental Inc
Met One Instruments Inc
SEE AD ON PAGE 43, 85

Metrotronics Inc
OI Analytical
Oiland Safety
Pace Transducer Div of
CJ Instruments Inc
R E Wright Environmental Inc
SRI Instruments
Scott Lawson Group Inc, The

SEE AD ON PAGE 43, 85
Manning Environmental Inc
Met One Instruments Inc
SEE AD ON PAGE 43, 85

SEE AD ON PAGE 43, 85
Manning Environmental Inc
Met One Instruments Inc
SEE AD ON PAGE 43, 85

SEE AD ON PAGE 43, 85
Manning Environmental Inc
Met One Instruments Inc
SEE AD ON PAGE 43, 85

SEE AD ON PAGE 43, 85
Manning Environmental Inc
Met One Instruments Inc
SEE AD ON PAGE 43, 85

SEE AD ON PAGE 43, 85
Manning Environmental Inc
Met One Instruments Inc
SEE AD ON PAGE 43, 85

SEE AD ON PAGE 43, 85
Manning Environmental Inc
Met One Instruments Inc
SEE AD ON PAGE 43, 85

SEE AD ON PAGE 43, 85
Manning Environmental Inc
Met One Instruments Inc
SEE AD ON PAGE 43, 85

PRODUCTS/SERVICES

Insurance

 **800-327-1414**

ECS Underwriting Inc
SEE AD ON PAGE 55

 **800-377-4152**

Freiburg Environmental Inc
Structural North America
SEE AD ON PAGE 22
Texas Workers' Compensation Insurance Fund
SEE AD ON PAGE 70, 98
Van Oppen & Co
Wharton Environmental

Intake Screens

Atlantic Screen & Mfg
Cook Screen Technologies Inc
Envirex Inc
Wheelabrator Technologies Inc

Intercomms

Atkinson Dynamics
David Clark Co Inc

Ion Exchange

Alton Geoscience Inc
Applied Membranes Inc
Envirox Inc
Environmental Systems Engineering Inc
GeoPure Systems & Services
Haley & Aldrich Inc
Industrial Filter & Pump Mfg Co
Kinetic Inc Engineered Systems Div
Mazzei Injector Corp
Osmonics Inc
SEE AD ON PAGE 25
Samsco Inc
SEE AD ON PAGE 101
Serflco Lts
Smith & Loveless Inc
Treatment Technologies
United States Filter Corp
Western Filter Co
Whattman Inc
Wheelabrator Clean Water Inc - HPD Div
Wheelabrator Clean Water Inc - Memtec Div

Labeling

Basco Inc
Brady USA Inc Signmark Div
D G Supplies Inc
Diagraph Corp
National Marker Co
Seton Identification Products
Stanley Storage Systems
Valien Safety Supply Co

Laboratory Equipment/Supplies

ABB Air Preheater Inc Raymond Prods
American Environmental Instruments Inc
American Safety & Abatement Products Inc
Argus Environmental Monitoring
Assay Technology Inc
B.J. Scientific Products Inc
BIOS Intl Inc
Bio-Tek Instruments
Brinkmann Instruments Inc
Buck Scientific Inc
CEA Instruments Inc
CEM Corp
Chometrics Inc
Del Mar Scientific Inc
Direct Safety Co
Dival Safety Equipment
Eagle-Picher/E S AT
Empac Corp
Entech Instruments Inc
Envirox Inc
Extech Instruments
Gilian Instruments
Glas-Col
HEMCO Corp

 **800-227-4224**

Hach Co
Haws Drinking Faucet Co
Hazoze Services Inc
Helma Cells Inc
Horiba Instruments Inc
Justrite Manufacturing Co LLC
Lab-Line Instruments Inc
Labonco Corp
MKS Instruments Inc
Millipore Corp
Misonix Inc
Myraid Industries
National Technical Information Service
New Pig Corp
SEE AD ON PAGE 19, 99

Nuairc Inc
OI Analytical
Ohaus Corp
Omega Engineering Inc
SEE AD ON PAGE 2
Orbeco Analytical Systems Inc
Osmonics Inc
SEE AD ON PAGE 25

Osram Sylvania Inc
Perkin-Elmer Corp
Polybac Corp
Polyfoam Packers Corp
Pope Scientific Inc
Rietek Corp
Rite in the Rain Fieldbooks
SKS Bottle & Packing Inc
SRI Instruments
Safety Storage Inc
SEE AD ON PAGE 39, 79
Scott Specialty Gases
Sensidyne Inc
Spectrex Corp
Spectronics Corp
Structure Probe Inc/SPI Supplies
Tegal Scientific Inc
Tekmar Co
Terra Universal Inc
U S Best
United McGill Corp
Valien Safety Supply Co
Wheaton Science Products
Wilkins-Anderson Co
Wonder Makers Inc
Zellweger Analytics Inc

Laboratory Services/Testing

Adirondack Environmental Associates Inc
Adrian Brown Consultants Inc
Air Toxics Ltd
Allied Environmental Consultants Inc
American Standards Testing Bureau Inc
Aqua Tech Environmental Laboratories Inc (ATEL)
Bio-Pho Laboratories Inc
Bird Machine Co Inc
Bovar Environmental
Braun Intertec Corp
Brooklyn Thermometer Co Inc
CEA Instruments Inc
CTL Environmental Services
Camp Dresser & McKee Inc
Clean Air Engineering
Clean Harbors Environmental Services Inc
Colloid Environmental Technologies Co
Con-Test/ATC Environmental Inc
Dixon Information Inc
EAS Laboratories
Eckenfelder Inc
Ensolech Inc
Entech Instruments Inc
Environmental Laboratory Services
Environmental Products & Services Inc
Environmental Science & Engineering Inc
Environmetrics
HES Inc
Hazen & Sawyer
Heritage Environmental Services Inc
Holzmaier McLendon & Murrell PC
Hygeia Environmental Laboratories Inc
InVtro Intl
SEE AD ON PAGE 163
L.J. Brotman & Assoc Ltd
Micro Analytical Laboratories Inc
Midwest Laboratories Inc
Mobile Medical Testing Service Inc

NUCON Intl Inc
National Technical Information Service

 **410-997-8700**

Niro Inc
Northern Lake Service Inc

 **509-375-3268**

Northwest Environmental Services
Testing & Training
Occupational Health & Hygiene Corp of America
Omega Engineering Inc
SEE AD ON PAGE 2

Pace Inc
Pacific Environmental Services Inc
SEE AD ON PAGE 56, 88
Peoria Disposal Co
Performance Analytical Inc
Pittsburgh Activated Carbon Services Inc
R E Wright Environmental Inc
RMT Inc
Raytheon Environmental Svcs/
Raytheon Engineers & Construction
Recon Environmental Corp
Rollins Environmental Services
Ross Analytical Services Inc
Roy F Weston Inc
S W Cole Engineering Inc
SERC0 Laboratories

 **800-323-5040**

Safety-Kleen Corp
Scott Lawson Group Inc, The
Soil Solutions Inc
Spectrex Corp
Structure Probe Inc/SPI Supplies
Teledyne Brown Engineering - Environmental Services
Testwell Craig Laboratories Inc
Tracer Research Corp
SEE AD ON PAGE 41
Traverse Group, The
Triangle Laboratories Inc
Western Filter Co
Wheelabrator Clean Water Inc - HPD Div
Wonder Makers Inc

Lagoon Separators/Baffles

Containment Systems
Environetics Inc
Environmental Recovery Resources Inc
JPS Elastomers Corp
North American Environmental Corp
Plastic Fusion Fabricators Inc
Slickbar Products Corp
Sunshine Technology Corp

Land Application Equipment

Ag-Chem Equipment Co Inc
Brown Bear Corp
Conti Environmental Inc
Liquid Waste Technology
SEE AD ON PAGE 65
Wheelabrator Technologies Inc

Land Application Systems

 **612-933-9006**

Ag-Chem Equipment Co Inc
BioGro Div Wheelabrator Clean Water Systems Inc
Grant Environmental
Liquid Waste Technology
SEE AD ON PAGE 65
Wheelabrator Technologies Inc
Wheelabrator Water Technologies Inc
Bio Gro Div
Yamada Science & Art Corp (YSA)

Land Assessment/Strip Chart Digitizations

Adrian Brown Consultants Inc

 **800-759-9282**

Air Science Consultants Inc

Landfills

Alton Geoscience Inc
Blasland Bouck & Lee Inc
CDM Federal Programs Corp
Clean Harbors Environmental Services Inc
EPG Companies
Environmental Education Enterprises E3
Foth & Van Dyke
Grant Environmental
Harding Lawson Associates
SEE AD ON PAGE 34
LWD Inc
Morrison Knudsen Corp
National Technical Information Service
Peoria Disposal Co
Performance Analytical Inc
R E Wright Environmental Inc
RMT Inc
Sharp & Associates Inc
Superior Special Services Inc
TENAX Corp
Western Water Consultants Inc

Landfills Equipment

A&J Environmental Supply
American Environmental Instruments Inc
Ameron Fiberglass Pipe
Atlantic Screen & Mfg
Burns & McDonnell Waste Consultants Inc
C H Hanson Co, The
CEA Instruments Inc

 **913-621-3700**

Columbian Steel Tank Co

 **914-246-3401**

EG & G Rotron - Industrial Products Div
EPG Companies
Finn Corp
Godwin Pumps of America Inc

 **419-755-1011**

Gorman-Rupp Co, The
SEE AD ON PAGE 3

Health Consultants Inc
John Zink Co Div Koch Engineering Co
Lamson Corp
Met-Pro Corp Systems Div
Plastic Fusion Fabricators Inc
Plexco

 **605-665-8770**

Portec C E D Environmental Products
QED Environmental Systems Inc
Reef Industries Inc
Rotobac
Sensidyne Inc
Zellweger Analytics Inc

Landfills Services

Alton Geoscience Inc
Blasland Bouck & Lee Inc
Braun Intertec Corp
Brown & Caldwell
CDM Federal Programs Corp
Chester Environmental
Conti Environmental Inc
Cura Inc
Dames & Moore
ERM Group Inc
Enercon Services Inc

Leachate Treatment

Environmental Products & Services Inc
Environmental Science & Engineering Inc
Environmental Technical Services Inc
Geo-Con
GeoTrans Inc
Haley & Aldrich Inc
Hazen & Sawyer
Heritage Environmental Services Inc
High Plains Consortium Inc
Hydro Group Inc

J&H 215-947-0930
Machine Co., Inc.

J & H Machine Co Inc
Kilham Associates
LWD Inc
Maxmillian Technologies Inc
Midwest Laboratories Inc
Organic Waste Technologies Inc
Plastic Fusion Fabricators Inc
R E Wright Environmental Inc
RMT Inc
Raytheon Environmental Svcs/
Raytheon Engineers & Construction
Remediation Inc
Rollins Environmental Services

 **716-284-0431**

Sevenson Environmental Services Inc
Sverdrup Environmental Inc
Tracer Research Corp
SEE AD ON PAGE 41
Western Water Consultants Inc
Williams Environmental Services Inc

Leachate Treatment

Aeromic Systems Inc
Alton Geoscience Inc
Andco Environmental Processes Inc
August Mack Environmental Inc
Blasland Bouck & Lee Inc
Brown & Caldwell
Cameron Environmental Inc
Chester Environmental
Conti Environmental Inc
Cura Inc
Davco Div Davis Water & Waste Industries Inc
ECO Purification Systems USA Inc
Eckenfelder Inc
Enercon Services Inc
Ensolech Inc
Environmental Products & Services Inc
Environmental Science & Engineering Inc
Environmental Tank Systems Inc (ETS)
Environmental Technical Services Inc
Geo-Con
GeoTrans Inc
Heritage Environmental Services Inc
High Plains Consortium Inc
Horizontal Technologies Inc
Hydro Group Inc
Met-Pro Corp Systems Div
Northwest Environmental Services Testing & Training
Oil Skimmers Inc
Organic Waste Technologies Inc
Plexco
Probiotic Solutions
QED Environmental Systems Inc
RMT Inc
Raytheon Environmental Svcs/
Raytheon Engineers & Construction
Recon Environmental Corp
Resources Conservation Co

 **716-284-0431**

Sevenson Environmental Services Inc
Sharp & Associates Inc
Smith & Loveless Inc
Sverdrup Environmental Inc
Treatment Technologies
U S Environmental Engineering Inc
United States Filter Corp
Vulcan Peroxidation Systems Inc
Water Equipment Technologies Inc
Wheelabrator Technologies Inc
Williams Environmental Services Inc
Zimpro Environmental Inc

PRODUCTS/SERVICES

Lead Paint Abatement

Lead Paint Abatement

Aramco
Cura Inc
Dival Safety Equipment
Enercon Services Inc
Ensolect Inc
Environmental Information Assoc. The
Environmental Waste Technology Inc
Fiberlock Technologies Inc
Gilan Instruments
Goodway Technologies Corp
HazWaste Technologies Corp
International Protective Coatings Corp
Jaca Corp
Keating Environmental Management Inc
National Technical Information Service
Neolenk Health Technologies Inc
North American Environmental Corp
P W Stephens Contractors Inc
Sensidyne Inc
Superior Industrial Maintenance Co Inc
Sverdrup Environmental Inc
Ultra-Research Inc
Williams Environmental Services Inc

Leak Detectors

Agar Corp Inc
American Environmental Instruments Inc
Argus Environmental Monitoring
Arizona Instrument Corp



800-635-7330

Art's Manufacturing & Supply



800-255-5008

Auburn International Inc

SEE AD ON PAGE 69

CEA Instruments Inc
Capital Controls Co Inc
Chemtrol Div of Nibco Inc
Controltron
Cura Inc
Deikon Inc
Dival Safety Equipment
EBW Inc
EFA Technologies Inc
EIT
Enmet Corp
Entech Instruments Inc
Environmental Systems Engineering Inc
Extch Instruments
FCI Environmental Inc



800-531-5465

Fluid Conservation Systems Inc

Fluid Components Intl

Fluid Containment Inc



800-321-0322

Foxboro Co. The
Gas Tech Inc
Gem Sensors Div
Geotech Environmental Equipment Inc
Goodway Technologies Corp
Grace Industries Inc
Hazzo Services Inc
Health Consultants Inc
Helima Cells Inc
Inficon Inc

SEE AD ON PAGE 117, 164

Intek Corp/Rent-Alyzer
International Sensor Technology
Ironics Inc
Jeram, Daniel L. Co
MKS Instruments Inc
McNeill Intl



408-734-1400

Metrotech Corp
NUCON Intl Inc
Nibco Inc

Omega Engineering Inc

SEE AD ON PAGE 2

Phonetics Inc

Photovac Monitoring Instruments

SEE AD ON PAGE 51, 57

Plastic Fusion Fabricators Inc

Rae Systems Inc

Scott Specialty Gases

Leak Detectors

Gilan Instruments

Sensor Electronics Corp

Sierra Monitor Corp

Spectra Gases Inc

Spectronics Corp

Stanley Storage Systems

Superior Signal Co Inc

Swagelok Companies, The

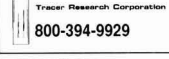

800-394-9929

Tracer Research Corp

SEE AD ON PAGE 41

Tracker Technologies Inc



408-749-0994

Turner Designs Inc

SEE AD ON PAGE 21

Vallen Safety Supply Co

Veeder-Roof Co

Zellweger Analytics Inc

Level Instrumentation

Advanced Data Systems
Agar Corp Inc
Atlantic Screen & Mfg
Campbell Scientific Inc
Coastal Environmental Systems
Control Electronics Inc
Custom Switches
Drexelbrook Engineering Co
Dwyer Instruments Inc
EIT
Epic Inc
Fopboro Co. The
Gem Sensors Div
GeoGuard Inc
Geotech Environmental Equipment Inc



916-863-0804

Global Water

Great Lakes Instruments

Handar



805-988-6800

Harnil Corp

Hawk America Inc

Hazzo Services Inc

Hydrolab Corp

SEE AD ON PAGE 40, 118



800-446-7488

In-Situ Inc

SEE AD ON PAGE 31

Instrumentation Northwest Inc (INW)

Instruments Direct Inc

Invalco Inc

K P S I

Keck Instruments Inc

Kistele-Morse

LCI Laser Compass Instruments Inc

Lundahl Instruments Inc



800-645-7339

MMC International Corp

SEE AD ON PAGE 24



Metritape Inc

Millronics Inc

Monitek Technologies Inc

North American Environmental Corp

ORS Environmental Systems

Peek Measurement

Plast-O-Matic Valves Inc

QED Environmental Systems Inc

S J Electro Systems Inc

Serfilco Lts

Sparing Instruments Co Inc

Telog Instruments Inc

Level, Sight Gauges

A & J Management Resources Inc
Art's Manufacturing & Supply
Dwyer Instruments Inc
Gem Sensors Div
Omega Engineering Inc

SEE AD ON PAGE 2

Plast-O-Matic Valves Inc

Lift Stations

Exploration Products

SEE AD ON PAGE 71

Goad Co



419-755-1011

Gorman-Rupp Co, The

SEE AD ON PAGE 3, 102

M L E

New Pig Corp

SEE AD ON PAGE 49, 99

Sauereisen

Lime Slakers

Chem-Tainer Industries
L & L Process Industries Inc
Smith & Loveliss Inc
Vulcan Iron Works Inc

Liners

A&J Environmental Supply
B A G Corp
Ben Meadows Co
C H Hanson Co. The
CMS Industries Inc
Conti Environmental Inc
Exploration Products

SEE AD ON PAGE 71



800-621-8546

Fabrico Environmental Liners Inc

GSE Lining Technology Inc

Goad Co

Horizontal Technologies Inc

JPS Elastomers Corp

MPC Containment Systems Ltd

National Seal Co

Packaging Research & Design

Pactec Inc

Plastic Fusion Fabricators Inc

Poly-Flex Inc

Rabtko Environmental Liners Inc

Raven Lining Systems

Reef Industries Inc

Seaman Corp

Skolnik Industries Inc

Wyo-Ben Inc

Liquid Extractors

Baler Equipment Co

CINC

SEE AD ON PAGE 25

Clean Harbors Environmental

Services Inc

Environmental Recovery Resources Inc

Environmental Systems Engineering Inc



Flo Trend Systems Inc

SEE AD ON PAGE 64, 91

Frontier Technology Inc

International Reserve Equipment Corp

Sebright Products

Locators, Pipe/Valve/Cable

Brady USA Inc Signmark Div
Enviro-Map Inc
Hazzo Services Inc
Health Consultants Inc
Jerman, Daniel L. Co



408-734-1400

Metrotech Corp

Reef Industries Inc

Schonstedt Instrument Co

Make-up Air System

Hartzell Fan Inc
Mazzei Injector Corp
NUCON Intl Inc
Remediation Service Intl

Management Services

Allied Environmental Consultants Inc
Anton Geosience Inc
CDM Federal Programs Corp
CTL Environmental Services
Cura Inc
Durr Environmental Systems
Dyncorp Environmental Energy & Natl Security Programs
ELB & Associates Inc
ERM Group Inc
ESSC (Earth Systems & Solutions Corp)
Enercon Services Inc
Environmental Science & Engineering Inc
Environmental Technical Services Inc
GeoTrans Inc
Grant Environmental
Haley & Aldrich Inc
Harding Lawson Associates
SEE AD ON PAGE 34
Heritage Environmental Services Inc
Lexicon Environmental Associates Inc



208-386-7150

Morrison Knudsen Corp

Nelson Enterprises

Occupational Health & Hygiene

Corp of America

PSG

R E Wright Environmental Inc

Radian Corp

Raytheon Environmental Svcs/

Raytheon Engineers & Construction

Roy F Weston Inc

Sverdrup Environmental Inc

Terra Consulting Group Inc

Traverse Group, The

Ultra-Research Inc

Vanco Engineering Group

Wheelabrator Clean Water Inc - HPD Div

Manometers

American Sity & Abatement Products Inc
Aramco
Dival Safety Equipment
Dwyer Instruments Inc
Hazzo Services Inc
Pace Transducer Div of
CJ Instruments Inc
Solomat - Neotronics
Tylan General Inc

Meteorological

Material Safety Data Sheet Software



800-934-5917

GRC Intl Inc/Flow Gemini Systems

Medical Waste Disposal

ABB Air Preheater Inc Raymond Prods
Ducon Environmental Systems Inc
Harding Lawson Associates
SEE AD ON PAGE 34
Rollins Environmental Services
S & G Enterprises Inc
STP Specialty Technical Publishers Inc
Salaco Products Co
Vulcan Iron Works Inc

Mercury Instruments

Anarad Inc
Arizona Instrument Corp
Bacharach Inc
BioNebraska Inc
Buck Scientific Inc
Epic Inc
Ionics Inc
Right-To-Know Training Institute

Mercury Spill Cleanup Products

American Safety & Abatement Products Inc
Bamebey & Sutcliffe Corp
Dival Safety Equipment
Environmental Products & Services Inc
JT Baker Div of Mallinckroft Baker Inc
Myrad Industries
New Pig Corp
SEE AD ON PAGE 49, 99
Vallen Safety Supply Co

Metal Fixation



716-284-0431

Sevenson Environmental Services Inc

Metal Recovery Systems

ABB Air Preheater Inc Raymond Prods
College Research Corp (CORECO)
Corean Technology Inc
Desalination Systems Inc
Global Equipment Marketing Inc
Horsehead Resource Development Co Inc
Innovative Concepts Program
International Reserve Equipment Corp
Kinetic Inc Engineered Systems Div
Met-Pro Corp Systems Div
Northwest Environmental Services
Testing & Training
Safety-Kleen Corp
Serfilco Lts
U S Environmental Engineering Inc
United States Filter Corp
Water Equipment Technologies Inc
Wheelabrator Clean Water Inc - Memtek Div
Wheelabrator Technologies Inc

Meteorological

Adrian Brown Consultants Inc
Air Resource Specialists Inc



800-759-9282

Air Science Consultants Inc
Applied Technologies Inc
Ben Meadows Co
Bovar Environmental
Campbell Scientific Inc
Climatronics Corp
SEE AD ON PAGE 110
Coastal Environmental Systems
Dames & Moore
Environmental Systems Corp
Epic Inc

HERE'S SOMETHING ELSE YOUR ENVIRONMENTAL ENGINEERING FIRM CAN DEPEND ON

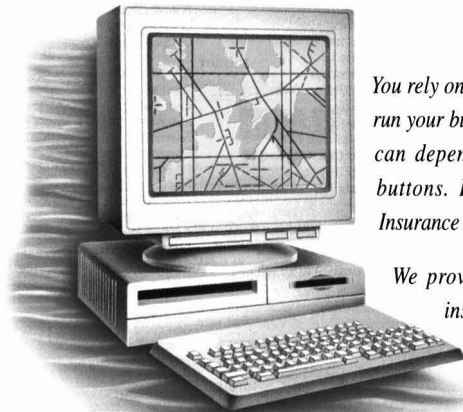

You rely on all sorts of technical equipment to run your business. But there's another tool you can depend on that doesn't have dials or buttons. It's the Environmental Liability Insurance Program from CNA/Schinnerer.

We provide broad professional liability insurance including pollution liability and contractors' pollution liability coverage for environmental engineers and consultants. Of course, that's only natural since we invented professional liability insurance for engineers almost 40 years ago. And now we're breaking new ground with reliable and cost-effective coverage that meets your environmental liability needs.

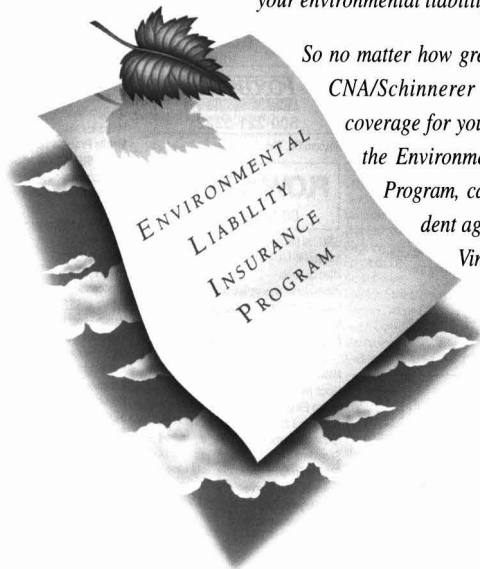

So no matter how great or small your risk, CNA/Schinnerer has the appropriate coverage for you. To learn more about the Environmental Liability Insurance Program, call or have your independent agent or broker contact Cris Vincent at (301) 951-9740.

Victor O.
Schinnerer
& Company, Inc.
CNA
For All the Commitments You Make®

Victor O. Schinnerer & Company, Inc. Two Wisconsin Circle, Chevy Chase, MD 20815-7022. Phone: (301) 961-9800. Fax: (301) 951-5444. Coverage provided by Continental Casualty Company, one of the CNA Insurance Companies/CNA Plaza/Chicago, IL 60685. CNA is a registered service mark of the CNA Financial Corporation. This advertisement is not a contract. Only the policy can provide the actual description of services, terms, conditions and exclusions. Program availability is subject to approval by your state insurance department.

Circle 98 on card.

Meteorological

Global Water
Handar
Hazzo Services Inc

541-471-7111
Met One Instruments

Met One Instruments Inc
SEE AD ON PAGE 43, 85

Novalyx Corp
R M Young Co
Raytheon Environmental Svcs/
Raytheon Engineers & Construction
Remtech Inc

800-788-5666

Scientific Sales Inc
Trinity Consultants Inc
Weather Network Inc
Yamada Science & Art Corp (YSA)

Meters

ABB Kent Meters Inc
BTR Instruments
Badger Meter Inc
Ben Meadows Co
Berman Inc
Brooks Instrument
Buck Scientific Inc
CEA Instruments Inc
Crompton Instruments Ltd
Crompton Instruments NA
Dynamics Inc
EMCO Flowmeters
Etech Instruments
Fluid Components Intl
Gurley Precision Instruments
Handar
Hawk America Inc
Hazzo Services Inc
Horiba Instruments Inc
ISTA Energy Systems Corp
Instrumark International Inc
Instrumentation Northwest Inc (INW)
Instruments Direct Inc
Intek Corp/Rent-Alyzer
Jerman, Daniel L, Co
Mars Co
Miltronics Inc
Modutec Inc
Montek Technologies Inc
Myriad Industries
Myron L Co
Omega Engineering Inc
SEE AD ON PAGE 2
Scott Lawson Group Inc, The
SeaMetrics Inc
Spectronics Corp
Taylor Technologies Inc
Vaisala Inc
Valien Safety Supply Co

209-784-3544

Water Specialties Corp

Microscopes

Ben Meadows Co
McCaffery & Ratner Inc
Myriad Industries

Nicolet
INSTRUMENTS OF INDIANAPOLIS
608-276-6100

Nicolet Instrument Corp
Terra Universal Inc

Mist Eliminators/ Collectors

516-467-1600

ACS Industries Inc
Air Plastics Inc
Andersen 2000 Inc
CVM Corp
Ceilco Air Pollution Control

CGS
516-467-1600

Clean Gas Systems Inc
Dual Div Met-Pro Corp
Ducon Environmental Systems Inc
Dusivent Inc
Harkinson Intl
Hyde Products
Jaeger Products Inc
Landtec Products Inc
Micro Air Cleaners by Metal-Fab Inc
Misonix Inc

314-275-5700

Monsanto Enviro-Chem Systems Inc
Norton Chemical Process Products Corp
United Air Specialists Inc

Mixers

Aeration Industries Intl Inc
Baker Tanks Inc
Basco Inc
Brinkmann Instruments Inc
CINC

SEE AD ON PAGE 25

Capital Controls Co Inc
Chemineer Inc
ELE Intl Inc/Soiltest Products Div
EMI Inc
Flo Trend Systems Inc
SEE AD ON PAGE 64, 91

Glas-Col
International Reserve Equipment Corp
Mitsu Machinery Distribution Inc
Myriad Industries
Netsch Inc
Pego Systems Inc
Pope Scientific Inc
Serfco Lts
Tekmar Co
U S Best
Universal Process Equipment Inc
Walker Process Equipment Div of
McNish Corp
Zimmerman Industries Inc

Mobile Labs

Advanced Containment Systems Inc
Aqua Tech Environmental
Laboratories Inc (ATEL)
Clean Air Engineering
Dodgen Mobile Technologies
E-N-G Mobile Systems Inc
ERM Group Inc
Eckenfelder Inc
Environmental Compliance Products
HEMCO Corp
Hazzo Services Inc
Hazen & Sawyer
Inchcape Testing Services/
Environmental Laboratories

MEDICAL COACHES
CORPORATION
607-432-1333

Medical Coaches Inc
Midwest Laboratories Inc
Pace Inc
Pittsburgh Activated Carbon Services Inc
R E Wright Environmental Inc
Shields Environmental Corp
Traverse Group, The

Moisture Instrumentation

Air Instruments & Measurements Inc
Anarad Inc
Applied Technologies Inc
Arizona Instrument Corp
CEM Corp
Campbell Scientific Inc
Clean Air Engineering
Climatronics Corp

SEE AD ON PAGE 110

Coastal Environmental Systems
Epic Inc
Johnson Yokogawa Corp
Ohaus Corp
Omega Engineering Inc
SEE AD ON PAGE 2

Solomat - Neotronics
Testo Inc
SEE AD ON PAGE 72
Vaisala Inc
Valien Safety Supply Co

Monitoring Systems, Air

Advanced Control Systems Corp
Advanced Pollution Instrumentation Inc
Advanced Sensors Inc
Air Instruments & Measurements Inc
AirScan Environmental Technologies Inc
Anarad Inc

Applied Automation
SEE AD ON PAGE 14, 120
Applied Technologies Inc
Argus Environmental Monitoring
Assay Technology Inc

Applied Automation
SEE AD ON PAGE 14, 120
Applied Technologies Inc
Argus Environmental Monitoring
Assay Technology Inc

auburn INTERNATIONAL
800-255-5008

Auburn International Inc
SEE AD ON PAGE 69

August Mack Environmental Inc
BG Inc
BIOS Intl Inc
Bacharach Inc
Baldwin Environmental Inc
BioSystems Inc
Bovar Environmental
Brady USA Inc Signmark Div
Bruel & Kjaer Instruments Inc
Buck Scientific Inc
CEA Instruments Inc
Campbell Scientific Inc
Clean Air Engineering
Clean World Engineering Ltd
Coastal Environmental Systems
Dancer Communications Inc
Dasibi Environmental Corp
Delton Inc
Digitronics Smet
Dural Safety Co
Dural Safety Equipment
Durr Environmental Systems
Dyna-FID Inc
ERM Group Inc
Energy Efficiency Systems Inc
Enmet Corp
Enltech Instruments Inc
Environics Inc
Environmental Products & Services Inc
Environmental Systems Corp
Enviroplan Inc
Fluid Components Intl
Foth & Van Dyke

FOXBORO
800-321-0322

Foxboro Co, The
GRC Intl Inc/Flow Gemini Systems
Gas Tech Inc
Goal Line Environmental Technologies
Global Equipment Marketing Inc
Goyen Value Corp
Graseby
SEE AD ON PAGE 15, 89

HEMCO Corp
Handar
Hazzo Services Inc
Horiba Instruments Inc
Insitac Inc
Intec Controls
Intek Corp/Rent-Alyzer
KVA/Analcat
Lamson Corp
Logic Beach Inc
Lumidor Safety Products
MKS Instruments Inc
McNeill Intl
Met One Instruments Inc
SEE AD ON PAGE 43, 85
Metronics Inc
Mil-Ram Technology Inc
Monarch Instrument
National Draeger Inc
National Technical Information Service
Novalyx Corp

OI Analytical
Oilind Safety
Ozarc Inc
Omega Engineering Inc
SEE AD ON PAGE 2
Perkin-Elmer Corp
Photovac Monitoring Instruments
SEE AD ON PAGE 51, 57
R E Wright Environmental Inc
RKI Instruments Inc
Rae Systems Inc
Restek Corp
Rosemont Analytical Inc
SCI-TEC Instruments Inc
Sensidyne Inc
Sharp & Associates Inc
Sierra Monitor Corp
Solomat - Neotronics
Spectra Gases Inc
Staplex Air Sampler Div
Summit Analyzers
Terra Universal Inc
Tracker Technologies Inc
U S Industrial Products Co Inc
United Sciences Inc
Valien Safety Supply Co
Wedding & Associates Inc
Wheelabrator Clean Air Systems Inc
Wheelabrator Technologies Inc
Wonder Makers Inc
Zellweger Analytics Inc

Monitoring Systems, Hazardous Material

Advanced Data Systems
American Environmental Instruments Inc
Aramco

800-635-7330

Art's Manufacturing & Supply
August Mack Environmental Inc
Ben Meadows Co
CEA Instruments Inc
Clean World Engineering Ltd
Dames & Moore
Dancer Communications Inc
Digitronics Smet
Dival Safety Equipment
EBW Inc
ERM Group Inc
Enviro-Map Inc
Environmental Compliance Products
Environmental Products & Services Inc
Environmental Waste Technology Inc
Foth & Van Dyke

FOXBORO
800-321-0322

Foxboro Co, The

FLOW GEMINI
800-934-5917

GRC Intl Inc/Flow Gemini Systems
Insitac Inc
Intec Controls
International Sensor Technology
Logic Beach Inc
Miltronics Inc
Mobile Process Technology
SEE AD ON PAGE 46, 127
National Technical Information Service
Nibo Inc
Perkin-Elmer Corp
R E Wright Environmental Inc
RKI Instruments Inc
Sensidyne Inc
Shields Environmental Corp
Sierra Monitor Corp
Spectrogram Corp
Strong Environmental Inc

Monitoring Systems, Water

Advanced Control Systems Corp
Advanced Data Systems
Air Instruments & Measurements Inc
Alton Geoscience Inc

Monitoring Systems, Water

800-635-7330

Art's Manufacturing & Supply
August Mack Environmental Inc
BTG Div of Spectris Technologies Inc
Ben Meadows Co
Buck Scientific Inc
Capital Controls Co Inc
Chemetronics Inc
Clean World Engineering Ltd
Coastal Environmental Systems
Coastal Leasing Inc
Dames & Moore
Dancer Communications Inc
Dig/COURSE Inc
Digitronics Smet
Diversified Well Products Inc
Durr Environmental Systems
EIT
ERM Group Inc
Enco EMC
Enviro-Map Inc
Environmental Products & Services Inc
Environmental Recovery Resources Inc
Environmental Systems Corp
FCI Environmental Inc
Fluid Components Intl
Foth & Van Dyke
Foxboro Co, The
G O Environmental Inc
GRC Intl Inc/Flow Gemini Systems
GUE Intl Inc
GeoTrans Inc
Geotech Environmental Equipment Inc
Global Water
Groundwater & Environmental Services
Inc
Hach Co
Handar
Hazzo Services Inc
Horiba Instruments Inc
HydroGeoLogic Inc
HydroLab Corp
SEE AD ON PAGE 40, 118
ISTA Energy Systems Corp

In-Situ Inc.
The Solutions People
800-446-7488

In-Situ Inc
SEE AD ON PAGE 31
Instrumentation Northwest Inc (INW)
Intec Controls
Ionics Inc
J L Rochester Co
Keck Instruments Inc
Logic Beach Inc
Manning Environmental Inc
Microbics Corp
Mil-Ram Technology Inc
Miltronics Inc
Mobile Process Technology
SEE AD ON PAGE 46, 127

Monarch Instrument
Montek Technologies Inc
Myron L Co
National Technical Information Service
Nibo Inc
Novalyx Corp
OI Analytical
Osmonics Inc
SEE AD ON PAGE 25
Perkin-Elmer Corp
Phonetics Inc
QED Environmental Systems Inc
R E Wright Environmental Inc
Rosemont Analytical Inc
Royce Instrument Corp
SERCO Laboratories
Schneider Instrument Co
Sensidyne Inc
Sharp & Associates Inc
Solomat - Neotronics
Spectrogram Corp
Taylor Technologies Inc
Traverse Group, The

TURNER DESIGNS
408-749-0994

Turner Designs Inc
SEE AD ON PAGE 21, 83
U S Environmental Engineering Inc

Monitoring Systems, Water

Valien Safety Supply Co
YSI Inc
Zellweger Analytics Inc

United McGill Corp
Valien Safety Supply Co

Motor Controllers

Advanced Control Systems Corp
Amb-Tech Safety Brakes
Baldor Electric Co
Boston Gear
Dwyer Instruments Inc
Environmental Systems Engineering Inc
Glas-Col
Grundfos Pumps Corp
Omega Engineering Inc
SEE AD ON PAGE 2
Remediation Service Intl
Rhombus Technology
Sumitomo

Noise/Sound Instruments

American Environmental Instruments Inc
American Sty & Abatement Products Inc
Argus Environmental Monitoring
BRD Noise & Vibration Control Inc
Bruel & Kjaer Instruments Inc
Campbell Scientific Inc
Dival Safety Equipment
Hazco Services Inc
Intek Corp/Rent-Alyzer
Metrosonics Inc
Mico Safety Rental
Scott Lawson Group Inc, The
Testo Inc
SEE AD ON PAGE 72
Valien Safety Supply Co



Time Mark Corp

Motors

A C Schultes of NJ, MD, & DE
Baldor Electric Co
Boston Gear
Gator Pump Inc
Glas-Col
Grundfos Pumps Corp
Sumitomo
Universal Process Equipment Inc
Westinghouse Motor Co

Nozzles

Bete Fog Nozzle Inc



Clean Gas Systems Inc
Cook Screen Technologies Inc
Ducon Environmental Systems Inc
Durrion Co Inc
EnviroCorp International Inc
Misonix Inc
OPW Fueling Components
Odor Control Co Inc
Spraying Systems Co
Valien Safety Supply Co

Nitrogen Oxide Detectors

Advanced Pollution Instrumentation Inc
Air Instruments & Measurements Inc
American Environmental Instruments Inc
American Sty & Abatement Products Inc
Anrad Inc
Argus Environmental Monitoring
Bacharach Inc
Biosystems Inc
CEA Instruments Inc
California Analytical Instruments Inc
Clean Air Engineering
Dasibi Environmental Corp
Delcon Inc
Dival Safety Equipment
EIT
Energy Efficiency Systems Inc
Emmet Corp

Nuclear Waste Handling Equipment

ABB Air Preheater Inc Raymond Prods
B-J Scientific Products Inc
Compacting Technologies
DeMarco MAX VAC Corp
Dival Safety Equipment
Enpac Corp
Environmental Compliance Products
National Technical Information Service
S & G Enterprises Inc
Safe Environmental Storage
Safety Storage Inc
SEE AD ON PAGE 39, 79
Shields Environmental Corp
Skolnik Industries Inc
Vulcan Peroxidation Systems Inc



Foxboro Co, The
Gas Tech Inc
Hazco Services Inc
Horiba Instruments Inc
Industrial Scientific Corp
Intek Corp/Rent-Alyzer
International Sensor Technology
Interscan Corp
McNeill Intl
Mi-Ram Technology Inc
Monitor Labs Inc
RKI Instruments Inc
SCI-TEC Instruments Inc
SKC Inc
Scott Lawson Group Inc, The
Sensidyne Inc
Sensor Electronics Corp
Siemens Energy & Automation Inc
Sierra Monitor Corp
Spectra Gases Inc
Summit Analyzers
Transducer Research Inc
U S Industrial Products Co Inc
Valien Safety Supply Co

Oceanographic Equipment

Campbell Scientific Inc
Coastal Environmental Systems
Coastal Leasing Inc
G O Environmental Inc
R M Young Co
Rite in the Rain Fieldbooks
Spectra Gases Inc
YSI Inc

Odor Control Equipment

ABB Air Preheater Inc
SEE AD ON PAGE 81
Adwest Technologies Inc
Air Plastics Inc
Airex Corp
Ambient Engineering Inc
American Gas Products Inc
Andersen 2000 Inc
Anguil Environmental Systems Inc
Barnebey & Sutcliffe Corp
Bovar Environmental
CVM Corp
CVT America LLC
Calgon Carbon Corp
Capital Controls Co Inc
Carbol Corp
Ceicote Air Pollution Control
Croll Reynolds Co Inc
Davis Process Div
Duall Div Met-Pro Corp
Durr Environmental Systems Inc
Ducon Environmental Systems Inc
Durr Environmental Systems
Dustvent Inc
EPG Companies
Electrosynthesis Co Inc

General Carbon Corp
HEMCO Corp
Hyde Products
ILC Dover Inc
John Zink Co Div Koch Engineering Co
Lamson Corp
Mazzi Injector Corp
Micro Air Cleaners by Metal-Fab Inc
Mico Safety Rental



Misonix Inc
NUCON Intl Inc
North American Environmental Corp



NuTech Environmental Corp
Odor Control Co Inc
Osmonics Inc
SEE AD ON PAGE 25

Ozact Inc
Ozonology Inc
Plastic Fusion Fabricators Inc
Plastronics Inc
Plenco
RFQ Environmental Systems Inc
RJ Environmental Inc
Reef Industries Inc
Remedial Systems Inc
Rusmar Inc
Sensidyne Inc
Serfilco Lts
Spencer Turbine Co, The
Spraying Systems Co
Syntechs Inc
Terra Universal Inc
3M Co (Performance Chemicals)



Unisorb Corp
Winsor & Jeraud

Odor Control Treatment

Ambient Engineering Inc
Bioscience Inc
Brown & Caldwell
CVT America LLC
Calgon Carbon Corp
Camp Dresser & McKee Inc
Carbol Corp
Chemical Lime Co
Chester Environmental



Clean Gas Systems Inc
Crown Technology Inc
Davis Process Div
Duall Div Met-Pro Corp
Durr Environmental Systems
Electrosynthesis Co Inc
EnsoTech Inc
EnviroInt Inc
Epolcon Corp of America
General Carbon Corp
Health Consultants Inc
Mazzi Injector Corp
Medina Agriculture Products Co Inc



Monsanto Enviro-Chem Systems Inc
North American Environmental Corp
Northwestern Carbon
NuTech Environmental Corp
Odor Control Co Inc
Odor Management Inc
Ozact Inc
Probiotic Solutions
RJ Environmental Inc
RMT Inc
Recon Environmental Corp
Rusmar Inc
Smith & Loveless Inc
Sverdrup Civic Inc

Sverdrup Environmental Inc
Symbion Chemicals Inc
TRC Environmental Corp
SEE AD ON PAGE 32
3M Co (Performance Chemicals)
Vulcan Peroxidation Systems Inc
W Canning Inc
Wheelabrator Clean Air Systems Inc
Wheelabrator Technologies Inc

Oil Skimmers

AFL Industries Inc
Abanaki Corp Oil Skimmer Div
Agar Corp Inc
Atlantic Screen & Mfg
Bay Marketing
Containment Systems
Dival Safety Equipment
EPG Companies
Envirex Inc
Environmental Products & Services Inc
Environmental Recovery Resources Inc
Environmental Systems Engineering Inc
Filterspun
Franco Environmental Technologies
Gemstone Environmental
Geotech Environmental Equipment Inc
Highland Tank & Mfg Co
Hudson Industries
Hyde Products
Kack Instruments Inc
Liquid Waste Technology
SEE AD ON PAGE 65
Megator Corp
Met-Pro Corp Systems Div
New Pig Corp
SEE AD ON PAGE 49, 99
North American Environmental Corp
Oil Skimmers Inc
QED Environmental Systems Inc
R E Wright Environmental Inc
Slickkar Products Corp
Silkwick Sorbents
Sunshine Technology Corp
Tenco Hydro Inc
U S Best
U S Environmental Engineering Inc

Oil Spill Control Equipment/Services

AFL Industries Inc
Adronack Environmental Associates Inc
Agar Corp Inc
Baker Tanks Inc
CINC
SEE AD ON PAGE 25
Camp Dresser & McKee Inc
Century West Environmental Inc
Clean Harbors Environmental
Services Inc
Containment Systems
Cura Inc
DeMarco MAX VAC Corp
Dival Safety Equipment
ERM Group Inc
Edwards & Cromwell Mfg Inc
Enpac Corp
Environmental Compliance Products
Environmental Container Corp
Environmental Products & Services Inc
Environmental Recovery Resources Inc
Exploration Products
SEE AD ON PAGE 71
G O Environmental Inc
GeoTrans Inc
Heritage Environmental Services Inc
Hudson Industries
Hyde Products
International Reserve Equipment Corp
New Pig Corp
SEE AD ON PAGE 49, 99
North American Environmental Corp
Oil Skimmers Inc
PND Corp
Petrol REM Inc
QED Environmental Systems Inc
R E Wright Environmental Inc
Safety Storage Inc
SEE AD ON PAGE 39, 79
Seaman Corp
Shields Environmental Corp
Skolnik Industries Inc
Slickkar Products Corp
Silkwick Sorbents
Spectrogram Corp
Sunshine Technology Corp

Oil/Water Separation

TRC Environmental Corp
SEE AD ON PAGE 32
UltraTech Intl Inc
Valien Safety Supply Co
Wolco Group Inc

Oil/Water Monitors

Agar Corp Inc
Alton Geosience Inc
American Environmental Instruments Inc
Dancer Communications Inc
Drexelbrook Engineering Co
Environmental Products & Services Inc
Environmental Recovery Resources Inc
Environmental Systems Engineering Inc
Global Water
Highland Tank & Mfg Co
Horiba Instruments Inc
Hyde Products
ISTA Energy Systems Corp
Instrumentation Northwest Inc (INW)
Invalco Inc
Ionics Inc
McTighte Industries Inc
Microphor Inc
Monitek Technologies Inc
North American Environmental Corp
Shimadzu Scientific Instruments Inc
Spectrogram Corp
Tracer Research Corp
SEE AD ON PAGE 41



Turner Designs Inc
SEE AD ON PAGE 21, 83

Oil/Water Separation

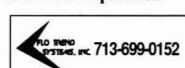

ACS Industries Inc
AFL Industries Inc
Abanaki Corp Oil Skimmer Div
Aeration Industries Intl Inc
Alfa Laval Sharpies,
Alfa Laval Separation Inc
Alton Geosience Inc
American Technologies Group Inc
Baker Tanks Inc
Bay Marketing
Bird Machine Co Inc
Brown-Minneapolis Tank
CINC
SEE AD ON PAGE 25
Carbonair Environmental Systems Inc
Carbol Corp
Davco Div Davis Water & Waste
Industries Inc
Deltech Engineering Inc
Ducon Environmental Systems Inc
EIMCO Process Equipment
Environmental Products & Services Inc
Environmental Recovery Resources Inc
Environmental Restoration Systems
Environmental Systems Engineering Inc
Filterspun



Flu Trend Systems Inc
SEE AD ON PAGE 64, 91

Fluid Containment Inc
Franco Environmental Technologies
Gensys Inc
GeoPure Systems & Services
Geotech Environmental Equipment Inc
Great Lakes Environmental Inc
Heritage Environmental Services Inc
Highland Tank & Mfg Co
Hudson Industries
Hyde Products
International Reserve Equipment Corp
Joseph Marketing Inc
Kraissl Co Inc
Krebs Engineers Inc
M L E
McTighte Industries Inc
Megator Corp
Microphor Inc

PRODUCTS/SERVICES

Cost-Effective Solutions For All Your Meteorological Needs

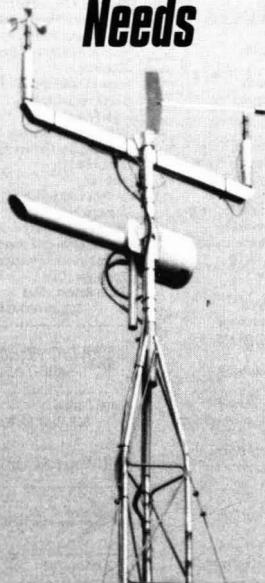

At Climatronics, we not only offer a complete line of weather systems, accessories and sensors, but also provide total system design, installation, repair and training. Systems are modular in design, and can be custom configured to your specific needs. Or, for more general applications, choose off-the-shelf packaged systems. Our sales engineers have the knowledge and experience to provide cost-effective solutions. Call today!

- **Wind Speed/Direction Sensors and Indicators**
- **Aspirated Shields, Towers & Accessories**
- **Portable, Automatic, Self Orienting Weather Stations**
- **Integrated Systems & Weather Station Networks**
- **ICAO CAT, II/IIA Airport Weather Stations**
- **UHF/VHF Spread Spectrum Communications Systems**
- **NIST Traceable Calibration & Repair Facilities**
- **Fully Compliant with EPA, PSD, NRC, 1.23 & 1.92, SARA Title III, CERCLA**



140 Wilbur Pl. Bohemia, NY 11716 USA
(516) 567-7300 • Fax: (516) 567-7585

Oil/Water Separation

Monarch Separators Inc
National Fluid Separators
New Pig Corp
SEE AD ON PAGE 49, 99
North American Environmental Corp
Oil Skimmers Inc
Osmonics Inc
SEE AD ON PAGE 25
Paragon Environmental Systems Inc
Parker Hannifin Corp
Power Plant Services
R E Wright Environmental Inc
RGF Environmental Systems Inc
Remedial Systems Inc
S C Altman & Associates
Samsco Inc
SEE AD ON PAGE 101
Sanborn Technologies
Serfilco Lts
Smith & Loveless Inc
Sunshine Technology Corp
Tenco Hydro Inc
U S Environmental Engineering Inc
United States Filter Corp

Opacity

Air Instruments & Measurements Inc
Air Source Technologies Inc
AirNova Inc
CVM Corp
Ducon Environmental Systems Inc



EMS Environmental Monitor Service
Environmental Systems Corp
Enviroplan Inc
Intex Corp/Pent-Alyzer
KVA/Analect
Land Combustion



MSI/Mechanical Systems Inc
Rosemount Analytical Inc
United Sciences Inc
Winsor & Jerauld

Operation & Maintenance Services

Allied Environmental Consultants Inc
Alton Geoscience Inc
CDM Federal Programs Corp



Camp Dresser & McKee Inc
Conti Environmental Inc
DRE Technologies
Dames & Moore
Delta Environmental Consultants Inc
ERM Group Inc
Enercon Services Inc
Environmental Products & Services Inc
Environmental Science & Engineering Inc
Epon Industrial Systems Inc
GeoTrans Inc
Hazen & Sawyer
Integrated Environmental Solutions Inc
SEE AD ON PAGE 35, 87
Keating Environmental Management Inc
Killam Associates
Millennium Science & Engineering Inc
Organic Waste Technologies Inc
OED Environmental Systems Inc
RMT Inc
Raytheon Environmental Svcs/
Raytheon Engineers & Construction
Remediation Service Intl
Superior Industrial Maintenance Co Inc
Sverdrup Environmental Inc
Vulcan Iron Works Inc
Wheelabrator Technologies Inc

ORP Instrumentation

American Environmental Instruments Inc
Applied Membranes Inc
Campbell Scientific Inc
Capital Controls Co Inc

Densorex
Extex Instruments
Foxboro Co, The
George Fischer Inc
Global Water
Hach Co
Hazzo Services Inc
HydroLab Corp
SEE AD ON PAGE 40, 118
Instrumentation Northwest Inc (INW)
Ionics Inc
Johnson Yokogawa Corp
Lakewood Instruments An Osmonics Co
Mettler-Toledo Process Analytical Inc
Monitek Technologies Inc
Rosemount Analytical Inc
Royce Instrument Corp
Schneider Instrument Co
Serfilco Lts
Solomat - Neotronics
U S Environmental Engineering Inc
YSI Inc

Oxidizers

ABB Air Preheater Inc
SEE AD ON PAGE 81
Adwest Technologies Inc
Airex Corp
Alton Geoscience Inc
Anguil Environmental Systems Inc
CVM Corp
College Research Corp (CORECO)



Durr Environmental Systems
ECO Purification Systems USA Inc
EPG Companies



Engelhard Corp
Environmental Restoration Systems
Environmental Systems Engineering Inc
Epon Industrial Systems Inc
Glenro Inc
Global Technologies
Goal Line Environmental Technologies
Grace Tec Systems
Lindberg
MMT Environmental Services Inc
Mazzei Injector Corp
Met-Pro Corp Systems Div

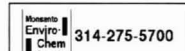

Monsanto Enviro-Chem Systems Inc
NUCON Intl Inc
North American Environmental Corp
North East Environmental Products Inc
Paragon Environmental Systems Inc
Pego Systems Inc
Probiotic Solutions
Process Combustion Corp
Prototech Co, The
Remediation Service Intl
S C Altman & Associates



Surface Combustion Inc
Unipure Environmental
United McGill Corp
Vulcan Peroxidation Systems Inc
Wheelabrator Clean Air Systems Inc
Winsor & Jerauld



Wolverine (Massachusetts) Corp

Oxygen Detectors

Air Instruments & Measurements Inc
American Environmental Instruments Inc
American City & Abatement Products Inc
Anarad Inc
Aramso

Ozone Detectors

Argus Environmental Monitoring
Bacharach Inc
Ben Meadows Co
Biosystems Inc
CEA Instruments Inc
California Analytical Instruments Inc
Clean Air Engineering
Columbus Instruments



Control Instruments Corp
Delton Inc
Dival Safety Equipment
Diversified Well Products Inc
EIT
Enmet Corp
Gas Tech Inc
Hazzo Services Inc
Health Consultants Inc
Industrial Scientific Corp
Intek Corp/Pent-Alyzer
International Sensor Technology
Johnson Yokogawa Corp
Lumidior Safety Products



MMC International Corp
SEE AD ON PAGE 24
McNeill Intl
Metrosonics Inc



Mil-Ram Technology Inc
Mico Safety Rental
Monitor Labs Inc
National Draeger Inc
Oilind Safety
RKI Instruments Inc
Rosemount Analytical Inc
SKC Inc
Scott Lawson Group Inc, The
Sensidyne Inc
Sensor Electronics Corp
Siemens Energy & Automation Inc
Sierra Monitor Corp
Valien Safety Supply Co
Zellweger Analytics Inc

Oxygen Ozone



Praxair Inc

Ozonators

AirSep Corp
Applied Membranes Inc
Colloid Environmental Technologies Co
DEL Industries
Envronics Inc
Lakewood Instruments An Osmonics Co
Mast/Keystone Inc
Mazzei Injector Corp
North East Environmental Products Inc
Osmonics Inc
SEE AD ON PAGE 25

Ozact Inc
Ozonology Inc
Progressive Equipment Corp
RGF Environmental Systems Inc
S C Altman & Associates
Spectronics Corp
U S Environmental Engineering Inc
Wheelabrator Technologies Inc
Worldwide Technology Inc

Ozone Detectors

Advanced Pollution Instrumentation Inc
Air Instruments & Measurements Inc
Anarad Inc
Argus Environmental Monitoring
CEA Instruments Inc
Columbia Scientific

Ozone Detectors

Dasibi Environmental Corp
 Dival Safety Equipment
 EIT
 Emnet Corp
 Hazzo Services Inc
 Intek Corp/Rent-Alyzer
 Lakewood Instruments An Osmonics Co
 Mast/Keystone Inc
 McNeill Intl
 Metrosonics Inc
 Mi-Ram Technology Inc
 Monitor Labs Inc
Omega Engineering Inc
 SEE AD ON PAGE 2
 Orbeco Analytical Systems Inc
Osmonics Inc
 SEE AD ON PAGE 25
 Ozact Inc
 RKI Instruments Inc
 Radon Detection Systems Inc
 Rosemount Analytical Inc
 SCI-TEC Instruments Inc
 Scott Lawson Group Inc, The
 Sensor Electronics Corp
 Spectra Gases Inc



Spectrex Corp
 Transducer Research Inc
 Vallen Safety Supply Co
 Worldwide Technology Inc
 Zellweger Analytics Inc

Packaged Treatment Plants

Aeration Industries Intl Inc
 Andco Environmental Processes Inc
 BioTrol Inc
 Bioscience Inc
 Carbonair Environmental Systems Inc
 Chief Industries Inc
 College Research Corp (CORECO)
 Colloid Environmental Technologies Co
 Davco Div Davis Water & Waste
 Industries Inc
 Durron Co Inc
 ECO Purification Systems USA Inc
 Environmental Systems Engineering Inc
 Environmental Tank Systems Inc (ETS)
 Ionics Inc
 M L E
 Met-Pro Corp Systems Div
 Progressive Equipment Corp
 Purestream Inc
 QED Environmental Systems Inc
 Remedial Systems Inc
 Remediation Service Intl
 Seghers Dinamex Inc



Sevenson Environmental Services Inc
 Smith & Loveless Inc
 Treatment Technologies
 U S Environmental Engineering Inc
 Zimpro Environmental Inc

Packing Materials

Basco Inc



Clean Gas Systems Inc
 D G Supplies Inc
 Drip Free Packing Co
 Ducon Environmental Systems Inc
 Environmental Restoration Systems
 John Crane Intl
 North American Environmental Corp
 North American Software Inc
 Norton Chemical Process Products Corp

Parametric Emission Monitors



MSI/Mechanical Systems Inc

Particle Detectors

Argus Environmental Monitoring
 Environmental Systems Corp
 Gilian Instruments
 Hazzo Services Inc
 Intek Corp/Rent-Alyzer
 NUCON Intl Inc
 SKC Inc
 Sensidyne Inc
 Terra Universal Inc
 United Sciences Inc

Particle Sizing Instruments

Atlantic Screen & Mfg
 Clean Air Engineering
Graseby
 SEE AD ON PAGE 15, 89
 Horiba Instruments Inc
 Instec Inc
 Krebs Engineers Inc
 Rotex Inc



Spectrex Corp
 Terra Universal Inc

Passive Hydrocarbon Recovery System

American Gas Products Inc
 Boart Longyear Co
 EnviroProducts Inc
 Environmental Recovery Resources Inc
 Environmental Systems Engineering Inc
 Keck Instruments Inc
 QED Environmental Systems Inc
 Remediation Service Intl

PCB Replacement

Allied Environmental Consultants Inc
 Environmental Products & Services Inc
 Rollins Environmental Services
 Sharp & Associates Inc

PCB Testing

Allied Environmental Consultants Inc
 Aqua Tech Environmental
 Laboratories Inc (ATEL)
 Bovar Environmental
 Braun Interlec Corp
 Burns & McDonnell Waste
 Consultants Inc
 Camp Dresser & McKee Inc
 ERM Group Inc
 Enercon Services Inc
 EnsoTech Inc
 Environmental Products & Services Inc
 Environmental Science & Engineering Inc
 Envrometrics
 HES Inc
 Incapac Testing Services/
 Environmental Laboratories
 Keating Environmental Management Inc
 Midwest Laboratories Inc
 Millipore Corp
 North American Environmental Corp
 Northern Lake Service Inc
Pacific Environmental Services Inc
 SEE AD ON PAGE 56, 88
 Performance Analytical Inc
 R E Wright Environmental Inc
 Raytheon Environmental Svcs/
 Raytheon Engineers & Construction
 Rollins Environmental Services
 Ross Analytical Services Inc
 Roy F Weston Inc
 SERCO Laboratories
 SRI Instruments
 Sharp & Associates Inc

Testwell Craig Laboratories Inc
 Williams Environmental Services Inc

Permitting

ABB Environmental Services Inc
 AMSCO Inc



Adrian Brown Consultants Inc
 AirNova Inc
 Alton Geoscience Inc
 August Mack Environmental Inc
 Bennett & Associates Inc
 Blymyer Engineers Inc
 Bovar Environmental
 CMI Federal Programs Corp
 CTL Environmental Services



Camp Dresser & McKee Inc
 Capsule Environmental Engineering Inc
 Century West Environmental Inc
 Chester Environmental
 Clean Air Engineering



Durr Environmental Systems
 ENSR
 ERM Group Inc
 ESSC (Earth Systems & Solutions Corp)
 Enviro-Assist Inc
 Environmental Resource Center
 Environmental Science & Engineering Inc
 Environmental Technical Services Inc
 Foth & Van Dyke
 GeoTrans Inc
 Groundwater & Environmental
 Services Inc
 H H Burkitt Project Mgmt Inc
 Haley & Aldrich Inc
Harding Lawson Associates
 SEE AD ON PAGE 34

Heritage Environmental Services Inc
 High Plains Consortium Inc
 Holzmacher McLendon & Murrell PC
 ICF Kaiser International Inc
 Kemper Risk Management Services
 Kilam Associates
 Morrison Knudsen Corp
 North American Environmental Corp
 Permit Tracker Software
 R E Wright Environmental Inc
 RMT Inc

Raytheon Environmental Svcs/
 Raytheon Engineers & Construction
 Recon Environmental Corp
 Roy F Weston Inc
 S W Cole Engineering Inc
 SSOE Inc
 Sewall, James W
 Sharp & Associates Inc
 Sverdrup Environmental Inc
TRC Environmental Corp
 SEE AD ON PAGE 32
 Testwell Craig Laboratories Inc
 Trinity Consultants Inc
 U S Environmental Engineering Inc
 Vanco Engineering Group



Waid & Associates
 Walk, Haydel & Associates Inc
 Williams Environmental Services Inc

Pest/Weed Control

Bird-X Inc
 InterNet Inc
 Seagull Technical Services
 Spectronics Corp
 Spraying Systems Co
 Sverdrup Environmental Inc

pH Instrumentation

Advanced Data Systems

Alton Geoscience Inc
 Applied Membranes Inc
 Ben Meadows Co
 Brinkmann Instruments Inc
 Capital Controls Co Inc
 Coastal Environmental Systems
 Densox
 EIT
 ELE Intl Inc/Soiltest Products Div
 Extch Instruments
 Foxboro Co, The
 George Fischer Inc
 Geotech Environmental Equipment Inc
 Global Water
 Great Lakes Instruments
 Haach Co
 Haley & Aldrich Inc
 Hazzo Services Inc
 Horiba Instruments Inc
Hydrolab Corp
 SEE AD ON PAGE 40, 118



Innovative Sensors Inc
 Instrumentation Northwest Inc (INW)
 Intek Corp/Rent-Alyzer
 Isoo Inc Environmental Div
 Johnson Yokogawa Corp
 Lakewood Instruments An Osmonics Co
 Mettler-Toledo Process Analytical Inc
 Monitek Technologies Inc
 Myriad Industries

New Pig Corp
 SEE AD ON PAGE 49, 99
 Novalyng Corp
 Orbeco Analytical Systems Inc
Osmonics Inc
 SEE AD ON PAGE 25

Rosemount Analytical Inc
 Royce Instrument Corp
 Schneider Instrument Co
 Serlenco Lts
 Taylor Technologies Inc
 Teegal Scientific Inc
 Telatemp Corp
 Terra Universal Inc
Testo Inc
 SEE AD ON PAGE 72

Vallen Safety Supply Co
 Wilkens-Anderson Co
 YSI Inc
 Zellweger Analytics Inc

Phase Converters



Key Industries Inc



Ronk Electrical Industries Inc

Pilot Plants

Brown & Caldwell
 Davco Div Davis Water & Waste
 Industries Inc
 GeoTrans Inc
 Glenlo Inc
 Hazen & Sawyer
 Heritage Environmental Services Inc
 Met-Pro Corp Systems Div
 NUCON Intl Inc
 Pope Scientific Inc
 Raytheon Environmental Svcs/
 Raytheon Engineers & Construction



Sevenson Environmental Services Inc



Surface Combustion Inc
 Sverdrup Environmental Inc

Pollution Survey Equipment

United States Filter Corp
 Universal Process Equipment Inc
 Wheelabrator Technologies Inc

Pipeline Cleaning, Repair

Environmental Technical Services Inc
 Goodway Technologies Corp



Insituform Technologies Inc
 LWD Inc
 Mars Co



Nibco Inc
 Plastic Fusion Fabricators Inc
 Superior Industrial Maintenance Co Inc
 Tapecoat Company, The

Piping, Dual Containment

Alton Geoscience Inc



Ameron Fiberglass Pipe
 Asari/America Inc
 Chemtrol Div of Nibco Inc
 Enco EMC
 Fibercast Co
 George Fischer Inc
 Goald Co



Insituform Technologies Inc
 MPC Containment Systems Ltd
 NewAge Industries Inc



Nibco Inc
 Phillip Driscoppe
 Plastic Fusion Fabricators Inc
 Plastronics Inc
 Plexco
 Smith Fiberglass Products Inc
 Thermoplastic Processes Inc
 Total Containment

Piping Equipment

Ameron Fiberglass Pipe
 Air's Manufacturing & Supply
 Baker Tanks Inc
 Diversified Well Products Inc
 Dow Plastic-Lined Piping Products
 Durton Co Inc
 Eslon Thermoplastics
 George Fischer Inc
 Goald Co
 Godwin Pumps of America Inc
 Jerman, Daniel L, Co
 Kraissl Co Inc
 Mars Co
 Rain for Rent
 Spectra Gases Inc
 Tapecoat Company, The
 Total Containment

Pollution Survey Equipment

American Environmental Instruments Inc



BVS Inc
 CEA Instruments Inc
 Cura Inc
 Cytex Industries Inc
 Instrumentation Northwest Inc (INW)

PRODUCTS/SERVICES

Pollution Survey Equipment

Intek Corp/Rent-A-Lyzer
QED Environmental Systems Inc
Remtech Inc
Rite in the Rain Fieldbooks
Schneider Instrument Co
Spectrogram Corp
TRC Environmental Corp
SEE AD ON PAGE 32
Ultra-Research Inc

Polymer Blending/Feeding Systems

Acrosion Inc
Andco Environmental Processes Inc
Colloid Environmental Technologies Co
Environmental Recovery Resources Inc
Fluid Dynamics Inc
Or-Tec Inc
Pope Scientific Inc

 **Sevenson Environmental Services, Inc.**
716-284-0431

Sevenson Environmental Services Inc
Stiles-Kern Div Met-Pro Corp
Tarty of Delaware Inc

Portable Computers

Keithley Metrabyte

Pre-Fabricated Trenches & Sumps

 **Sentry Polymers, Inc.**
409-233-0312

Sentry Polymers Inc

Predictive Emission Monitors

 **MSI**
608-825-2055

MSI Mechanical Systems Inc

Pressure Boosters

PACO Pumps
Spencer Turbine Co, The

Pressure/Vacuum Instrumentation

Advanced Data Systems
Automatic Switch Co (ASCO)
Campbell Scientific Inc
Capital Controls Co Inc
Dwyer Instruments Inc
Foxboro Co, The
Global Water
Infinicon Inc

SEE AD ON PAGE 117, 164
Instrumentation Northwest Inc (INW)
K P S I
MKS Instruments Inc

 **Mid-West Instrument**
800-648-5778

Mid-West Instrument
Omega Engineering Inc
SEE AD ON PAGE 2

Onset Computer Corp
Pace Transducer Div of
CJ Instruments Inc
Plast-O-Matic Valves Inc
Remediation Service Intl
Solomat - Neotronics
Spectra Gases Inc
Spencer Turbine Co, The
Tylan General Inc

Process Control Instrumentation

AGA Gas Inc
APV Anhydro-Separation Technologies
APV Heat Transfer Technologies

ASOMA/WTC Engineering
Aromag Inc
Advanced Data Systems
Ametek Inc Process & Analytical
Instruments Div
Ametek Proc & Analytical Instruments Div
Anvic Controls
Arthur Technology Inc

 **Auburn International**
800-255-5008

Auburn International Inc
SEE AD ON PAGE 69

Capital Controls Co Inc
Coastal Environmental Systems
Columbia Scientific
Custom Switches
Davis Process Div
Drexelbrook Engineering Co
Durr Environmental Systems
Dwyer Instruments Inc
Extch Instruments
Foxboro Co, The
Gem Sensors Div
Goald Co

 **HACH**
800-227-4224

Hach Co
Hawk America Inc
Hazen & Sawyer
Helma Cells Inc
Horiba Instruments Inc
Infinicon Inc
SEE AD ON PAGE 117, 164

Intec Controls
J L Rochester Co
K P S I
Keithley Metrabyte
Logic Beach Inc
MKS Instruments Inc
Mettler-Toledo Process Analytical Inc
Milltronics Inc
Monitek Technologies Inc
National Instruments
Parker Hannifin Corp
Perkin-Elmer Corp
Phonetics Inc
Plast-O-Matic Valves Inc
QED Environmental Systems Inc
R E Wright Environmental Inc
RKI Instruments Inc
RMJ Machinery Inc
Remediation Service Intl
Schneider Instrument Co
Spectra Gases Inc
Spencer Turbine Co, The
Taylor Technologies Inc

 **TURNER DESIGNS**
408-749-0994

Turner Designs Inc
SEE AD ON PAGE 21, 83
Tylan General Inc

Professional & Trade Associations

National Technical Information Service
Powder Coating Institute Inc

Programmable Controllers/Timers

Advanced Control Systems Corp
BTR Instruments
Carbonair Environmental Systems Inc
Crompton Instruments Ltd
Crompton Instruments NA
Digitronics Inc
Dwyer Instruments Inc
Extch Instruments
Hiophane Corp
Modulec Inc
National Controls Corp
Omega Engineering Inc
SEE AD ON PAGE 2
QED Environmental Systems Inc
R E Wright Environmental Inc

Protective Clothing

AGA Gas Inc
American City & Abatement Products Inc
Aramco
Argus Environmental Monitoring
Bay Marking
Direct Safety Co
First Fabrics Inc
Hazco Services Inc
ILC Dover Inc
Magid Glove & Safety Mfg Co
National Draeger Inc
New Pig Corp

SEE AD ON PAGE 49, 99

Racal Health & Safety Inc
Steele Inc
Terra Universal Inc
Valten Safety Supply Co

Publications

Ariel Research Corp
Bailey Controls Co
Donley Technology
EnviroSafety Directory (No. 1423)
Government Institutes
J J Keller & Associates
Legi-Slate

SEE AD ON PAGE 10, 113

Mabbett & Associates Inc
N B Olewine Co Inc, The
National Technical Information Service
Pittsburgh Activated Carbon Services Inc
R E Wright Environmental Inc
STP Specialty Technical Publishers Inc
Ultra-Research Inc

Pulverizers

ABB Air Preheater Inc Raymond Prods
American Pulverizer Co
Brinkmann Instruments Inc
Conti Environmental Inc
International Reserve Equipment Corp
Misonix Inc
SSI Shredding Systems Inc
Universal Process Equipment Inc
Wyssmont Co Inc

Pump Controllers

Anvic Controls
Boart Longyear Co
Carbonair Environmental Systems Inc
Custom Switches

 **DIAGENEX**
510-606-5600

Diagenex Inc
Diversified Well Products Inc
Dwyer Instruments Inc
EPG Companies
Environmental Restoration Systems
Environmental Systems Engineering Inc
FMI Fluid Metering Inc
GeoGuard Inc
GeoPure Systems & Services

 **GR PUMPS**
419-755-1011

Gorman-Rupp Co, The
SEE AD ON PAGE 3

Grundfos Pumps Corp
Hawk America Inc
Luft Instruments Inc
Milltronics Inc
ORS Environmental Systems
Omega Engineering Inc
SEE AD ON PAGE 2
PACO Pumps
Pumpex Inc
QED Environmental Systems Inc
R E Wright Environmental Inc
Remediation Service Intl
Rhombus Technology
S J Electro Systems Inc
SeaMetrics Inc
Sharp & Associates Inc

Pumps (sludge, wastewater, groundwater, misc.)

 **TIME MARK CORPORATION**
918-438-1220

Time Mark Corp

 **VANTOP**
908-688-4216

Vantop Pump & Equipment Corp

Pumping Stations/Systems

A C Schultes of NJ, MD, & DE
American Lewa Inc
Anvic Controls
Barnes Pumps Div of
Crane Pumps & Systems
Davco Div Davis Water & Waste
Industries Inc
Durricon Co Inc
Edson Intl
EnviroTech Pumpsystems
Environmental Systems Engineering Inc
Godwin Pumps of America Inc

 **GR PUMPS**
419-755-1011

Gorman-Rupp Co, The
SEE AD ON PAGE 3
Hydro Group Inc

 **MSI**
608-825-2055

IMS Inc (Innovative Material Systems Inc)

 **ITT A-C Pump**
513-482-2500

ITT A-C Pump/ITT Marlow
Kraissl Co Inc
M L E

Omega Engineering Inc
SEE AD ON PAGE 2

PACO Pumps
Pumpex Inc
R E Wright Environmental Inc
Remediation Inc
Remediation Service Intl
SRS Crisafulli Inc
Serfilco Lts
Sharp & Associates Inc
Smith & Loveless Inc
Tarty of Delaware Inc
U S Environmental Engineering Inc

 **VANTOP**
908-688-4216

Vantop Pump & Equipment Corp

Pumps (sludge, wastewater, groundwater, misc.)

A C Schultes of NJ, MD, & DE
Alfa Lava Pumps Inc
American Lewa Inc
Applied Membranes Inc

 **Art's Manufacturing & Supply**
800-635-7330

Art's Manufacturing & Supply
Atlantic Screen & Mfg
Baker Tanks Inc
Barnes Pumps Div of Crane
Pumps & Systems
Basco Inc
Blacker/ADover Resources Co
Boart Longyear Co
Brailsford & Co Inc
Busch Inc
CH & E Mfg Co Inc
Cornel Pump Co
Dean Pump Div Met-Pro Corp
Diversified Well Products Inc

Durricon Co Inc
EPG Companies
Edson Intl
Elicott Machine Corp Intl
Enviro Products Inc
EnviroProducts Inc
EnviroTech Pumpsystems
Environmental Restoration Systems
Environmental Systems Engineering Inc
FMI Fluid Metering Inc
Fairbanks Morse Pump Corp
Fillerspun
Fibroc Div Met-Pro Corp
Gardner Denver Machinery Inc

 **GATOR PUMP, INC.**
800-735-9811

Gator Pump Inc
GeoGuard Inc
GeoPure Systems & Services
Geotech Environmental Equipment Inc
Gilan Instruments
Goald Co
Godwin Pumps of America Inc

 **GR PUMPS**
419-755-1011

Gorman-Rupp Co, The
SEE AD ON PAGE 3

Grundfos Pumps Corp
Hazco Services Inc
Hyde Products
Hydro Group Inc

 **MSI**
608-825-2055

IMS Inc (Innovative Material Systems Inc)

 **ITT A-C Pump**
513-482-2500

ITT A-C Pump/ITT Marlow
Industrial Filter & Pump Mfg Co
Instrumentation Northwest Inc (INW)
International Reserve Equipment Corp
Justrite Manufacturing Co LLC
Keck Instruments Inc
Kraissl Co Inc
Lakeside Equipment Corp

 **LIT PIP HOG**
800-243-1406

Liquid Waste Technology
SEE AD ON PAGE 65

Little Giant Pump Co
Luft Instruments Inc
Lutz Pumps Inc
M L E
Megator Corp

Moyno Industrial Products Unit of
Robbins & Myers Inc
Netzsch Inc
ORS Environmental Systems
Omega Engineering Inc
SEE AD ON PAGE 2

Osmonics Inc
SEE AD ON PAGE 25

PACO Pumps
Pacer Pumps Div of ASM Industries Inc
Paragon Environmental Systems Inc
Plast-O-Matic Valves Inc
Protec
Pumpex Inc
QED Environmental Systems Inc
Rain for Rent

 **ROPER PUMP CO**
800-944-6769

Roper Pump Co
SRS Crisafulli Inc
Scott Lawson Group Inc, The
Sensidyne Inc
Serfilco Lts
Sethco Div Met-Pro Corp
Sharp & Associates Inc
Smith & Loveless Inc
Sol Solutions Inc
Stanley Hydraulic Tools

Pumps (sludge, wastewater, groundwater, misc.)

Stokes Vacuum Inc
Tatby of Delaware Inc



Timco Manufacturing Inc
U S Best
Universal Process Equipment Inc



Vanton Pump & Equipment Corp
Warman Intl Inc
Warren Advanced Composites
Warren Rupp Inc
Zimpro Environmental Inc

Pyrolytic Processing



Surface Combustion Inc

Radiometer/Radiation Instrumentation

Argus Environmental Monitoring
Biron NE
Campbell Scientific Inc
Coastal Environmental Systems
Enercon Services Inc
GTS Duratek
Hazco Services Inc
Intek Corp/Rent-Alyzer
Nuclear Associates

Radon, Testing & Analysis

CDM Federal Programs Corp
CTL Environmental Services
Enercon Services Inc

Harding Lawson Associates
SEE AD ON PAGE 34

Hazco Services Inc
Midwest Laboratories Inc
Milco Safety Rental
Nuclear Associates
Occupational Health & Hygiene
Corp of America

Pacific Environmental Services Inc
SEE AD ON PAGE 56, 88

Radon Detection Systems Inc
Rollins Environmental Services
Roy F Weston Inc

TRC Environmental Corp
SEE AD ON PAGE 32

Teledyne Brown Engineering -
Environmental Services

Recorder Accessories

Dwyer Instruments Inc
Foxboro Co, The
Hazco Services Inc
Instrumentation Northwest Inc (INW)
Kipp & Zonen

Met One Instruments Inc
SEE AD ON PAGE 43, 85

Metrosonics Inc
Monarch Instrument
Omega Engineering Inc
SEE AD ON PAGE 2

Rite in the Rain Fieldbooks

Recorders

Bailey Controls Co
CEA Instruments Inc
Campbell Scientific Inc
Capital Controls Co Inc
Climatronics Corp

SEE AD ON PAGE 110

Coastal Environmental Systems
Dancer Communications Inc
Diversified Well Products Inc
Dwyer Instruments Inc
EIT
Foxboro Co, The
Hazco Services Inc

Instrumentation Northwest Inc (INW)
Johnson Yokogawa Corp
Kipp & Zonen

Met One Instruments Inc
SEE AD ON PAGE 43, 85

Metrosonics Inc
Monarch Instrument
Novalyx Corp
Omega Engineering Inc
SEE AD ON PAGE 2

Rosemount Analytical Inc
Rustrak Instruments
Scientific Sales Inc
Serrillo Lts
Telog Instruments Inc

Recycling Equipment/Services

ABB Air Preheater Inc Raymond Prod
AGA Gas Inc
American Pulverizer Co
BFI (Browning Ferris Industries Inc)
Baler Equipment Co
Burns & McDonnell Waste
Consultants Inc

College Research Corp (CORECO)
Conti Environmental Inc
Crown Technology Inc
ELB & Associates Inc
ERASE Inc
ESSC (Earth Systems & Solutions Corp)
Environmental Compliance Products
Global Equipment Marketing Inc
Hazen & Sawyer
Heritage Environmental Services Inc
Horsehead Resource Development Co Inc
Hyde Products
International Reserve Equipment Corp
Kann Manufacturing Inc
Katec Inc
Killam Associates
Multitek Inc
National Technical Information Service
Netzsch Inc
Orvak USA Inc
Osprey Biotechnics
Piqua Waste Equipment Inc
Pope Scientific Inc



Portec C E D Environmental Products
Prodeva Inc
RGF Environmental Systems Inc
S C Altman & Associates
SRS Industrial Engineering Inc
Safeo Products Co



Safety-Kleen Corp
Samsco Inc
SEE AD ON PAGE 101

Sanborn Technologies
Saturn Shredders Div of MAC Corp
Seno-Us Lock
Shields Environmental Corp
Solvent Recovery Systems Inc



Surface Combustion Inc
Ultra-Research Inc
Vulcan Peroxidation Systems Inc

Reference Material

AccuStandard Inc
Analytical Products Group Inc
Clark Boardman Callaghan
D G Supplies Inc
Danatec Educational Services Ltd
Gordon & Breach Publishing
NIST - Standard Reference Materials
NSI Environmental Solutions Inc
National Technical Information Service
Restek Corp
Ricca Chemical Co
Ultra-Research Inc

Reflectometers

Ben Meadows Co



Spectra Gases Inc

Refractometers

Ben Meadows Co
Epic Inc
Myriad Industries

Refractory Materials

B-J Scientific Products Inc
Spectra Gases Inc

Regulators

Brooks Instrument
Hazco Services Inc
MKS Instruments Inc
Parker Hannifin Corp
Plast-O-Matic Valves Inc
Specialty Mfg Co, The

Remediation

A C Schultes of NJ, MD, & DE
ABB Environmental Services Inc
Abanaki Corp Oil Skimmer Div



Adrian Brown Consultants Inc
Allied Environmental Consultants Inc
Alternative Remedial Technologies Inc
Alton Geoscience Inc
American Technologies Group Inc

Remediation

Atlantic Fluidics Inc
August Mack Environmental Inc
Bioscience Inc
Blasland Bouck & Lee Inc
Blymyer Engineers Inc
Bovar Environmental
Brown Bear Corp

SEE AD ON PAGE 46, 84
CDM Federal Programs Corp
Cameron Environmental Inc
Camp Dresser & McKee Inc
Carbrol Corp



Cedarapids Inc A Raytheon Co
Century West Environmental Inc
Clean Harbors Environmental Services Inc
Clean Soil
Conti Environmental Inc

PRODUCTS/SERVICES

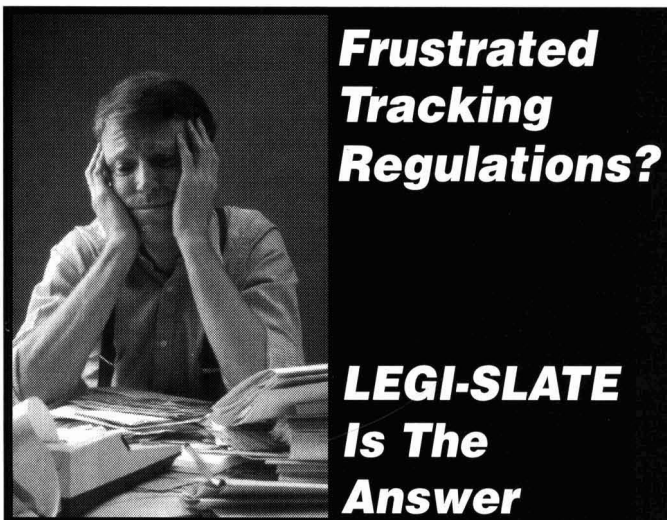

LEGI-SLATE® is the leading online service covering regulations and Congress. Our exclusive coverage offers timely, reliable and complete, value-added information for regulatory professionals. **LEGI-SLATE** is:

Timely

We provide the full text of today's *Federal Register* (and other documents) today.

Accurate

LEGI-SLATE takes pride in accurate coverage of the latest regulatory and legislative news. Value-added indexing makes it easy to identify information on your issues.

Complete

We offer comprehensive coverage of the *Federal Register*, *CFR*, *U.S. Code*, state regulations, BNA Online®, the U.S. Congress, and more.

Convenient

You don't have to be a computer wizard -- all information in LEGI-SLATE is in a friendly, easy-to-use format.

Save Time. Avoid Aggravation.

Call today to find out how LEGI-SLATE can help you.

(202) 898-2300 (800) 733-1131

(M-F 8:30am-5:00pm EST)

LEGI-SLATE® ▼ 777 North Capitol Street ▼ Washington, D.C. 20002

Remediation

DAMES & MOORE
213-683-0471

Dames & Moore
Delta Environmental Consultants Inc
Diversified Well Products Inc
EET Inc
ERM Group Inc
Earth Remediation Services Inc
Enercon Services Inc
Ensolech Inc
Environmental Education Enterprises E3
Environmental Products & Services Inc
Environmental Restoration Systems
Environmental Science & Engineering Inc
Environmental Systems Engineering Inc
Environmental Waste Technology Inc
Envirotrol Inc
Excel
Foth & Van Dyke
General Carbon Corp
GeoGuard Inc
GeoPure Systems & Services
GeoTrans Inc
GeoTrans Inc
Geotech Environmental Equipment Inc
Global Technologies
Great Lakes Environmental Inc
Groundwater Technology Inc
Haley & Aldrich Inc
Harding Lawson Associates

SEE AD ON PAGE 34

Hazclean Environmental Consultants Inc
Heritage Environmental Services Inc
Heyl & Patterson Inc Renneburg Div
Horizontal Technologies Inc
Hydro Group Inc
HydroGeoLogic Inc
ICF Kaiser International Inc
IHS Regulatory Products - EarthLaw
Integrated Environmental Solutions Inc
SEE AD ON PAGE 35, 87
Johnson & Associates Consulting

Keck Instruments Inc
Kruck Environmental Services Inc
Maxmillian Technologies Inc
Mazzel Injector Corp
Medina Agriculture Products Co Inc
Millennium Science & Engineering Inc
National Technical Information Service
National Technical Systems
North American Environmental Corp



Northwest Environmental Services
Testing & Training
Osprey Biotechnics
Petrol REM Inc
Portec C E D Environmental Products
ProBios Inc
Probiotic Solutions
R E Wright Environmental Inc
RMT Inc
Raytheon Environmental Svcs/
Raytheon Engineers & Construction
Remediation Inc
Remediation Service Intl
Rollins Environmental Services
Roy F Weston Inc
SSI Shredding Systems Inc
SSEO Inc
Serengeti Environmental



Severson Environmental Services Inc
Sharp & Associates Inc
Site Reclamation Systems Inc
Smith & Loveless Inc
Soil Solutions Inc
Sprung Instant Structures Inc
TRC Environmental Corp
SEE AD ON PAGE 32

Tetwell Craig Laboratories Inc
Therm Tech Inc
Traverse Group, The
U S Environmental Engineering Inc
University of Illinois Institute of Labor & Indus Relat
Vamco Engineering Group
Vulcan Peroxidation Systems Inc
Walk, Haydel & Associates Inc
Western Water Consultants Inc

Remediation, Insitu

ABB Air Preheater Inc Raymond Prods
ABB Environmental Services Inc
Adrian Brown Consultants Inc
Adwest Technologies Inc
Airex Corp
Allied Environmental Consultants Inc
Alton Geoscience Inc
August Mack Environmental Inc
Bioscience Inc
Blasland Bouck & Lee Inc
Blymyer Engineers Inc
Bovar Environmental
Braun Intertec Corp
Brown Bear Corp

SEE AD ON PAGE 46, 84

CDM Federal Programs Corp
Camp Dresser & McKee Inc
Century West Environmental Inc
Clean Harbors Environmental Services Inc
Clean Soil
Dames & Moore
Delta Environmental Consultants Inc
Diversified Well Products Inc
EIMCO Process Equipment
ERM Group Inc
Earth Remediation Services Inc
Eckenfelder Inc
Enercon Services Inc
Ensolech Inc
Environmental Education Enterprises E3
Environmental Products & Services Inc

Environmental Science & Engineering Inc
Environmental Systems Engineering Inc
Environmental Waste Technology Inc
Excel
Geo-Con
GeoTrans Inc
Grant Environmental
Groundwater Technology Inc
Haley & Aldrich Inc
Harding Lawson Associates

SEE AD ON PAGE 34

Heritage Environmental Services Inc
Heyl & Patterson Inc Renneburg Div
Horizontal Technologies Inc
Integrated Environmental Solutions Inc

SEE AD ON PAGE 35, 87

Johnson & Associates Consulting
Keating Environmental Management Inc
Keck Instruments Inc
Kruck Environmental Services Inc
Medina Agriculture Products Co Inc
Millennium Science & Engineering Inc
NUCON Intl Inc
National Technical Systems
Osprey Biotechnics
ProBios Inc
Probiotic Solutions
R E Wright Environmental Inc
RMT Inc
Raytheon Environmental Svcs/
Raytheon Engineers & Construction
Reef Industries Inc
Regensis Bioremediation Products
Remediation Inc
Remediation Service Intl
Roy F Weston Inc
Serengeti Environmental



Severson Environmental Services Inc
Site Reclamation Systems Inc
Sverdrup Environmental Inc

Remediation Services

TRC Environmental Corp
SEE AD ON PAGE 32

Tetwell Craig Laboratories Inc
Vamco Engineering Group
Walk, Haydel & Associates Inc
Williams Environmental Services Inc

Remediation Services

ABB Environmental Services Inc
Adirondack Environmental Associates Inc
Adrian Brown Consultants Inc
Allied Environmental Consultants Inc
Alternative Remedial Technologies Inc
Alton Geoscience Inc
August Mack Environmental Inc
Bioscience Inc
Blasland Bouck & Lee Inc
Blymyer Engineers Inc
Bovar Environmental
Braun Intertec Corp
Brown Bear Corp

SEE AD ON PAGE 46, 84

Burns & McDonnell Waste Consultants Inc
CDM Federal Programs Corp
CTL Environmental Services



Camp Dresser & McKee Inc
Capsule Environmental Engineering Inc
Carbtrol Corp
Century West Environmental Inc
Chemical Lime Co
Clean Harbors Environmental Services Inc
Clean Soil
Conti Environmental Inc
Cura Inc
Dames & Moore
Delta Environmental Consultants Inc
Diversified Well Products Inc

Comply With Model Building Codes. Insist on Haz-Stor.®



The storage of hazardous materials demands security, segregation and containment. UL's classification mark and data plate are proof positive you'll meet these demands. The *Haz-Stor*® premier family of buildings is designed and built to comply with Model Building Codes for Group H - Hazardous Occupancies. Every single unit is examined by UL's Independent Inspectors prior to shipment.

HAZ-STOR
HAZARDOUS MATERIALS STORAGE

Haz-Stor® Division of Justrite Manufacturing Company LLC
Subsidiary of Federal Signal Corporation



Phone 847-294-1000
Toll Free 800-798-9250
Fax 847-298-9716

©1996 Justrite Manufacturing Co.



Meteorological Instruments

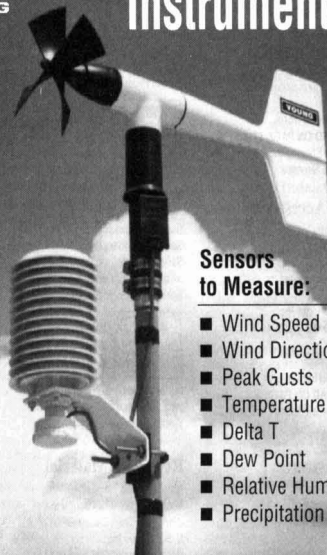

Sensors to Measure:

- Wind Speed
- Wind Direction
- Peak Gusts
- Temperature
- Delta T
- Dew Point
- Relative Humidity
- Precipitation

R. M. YOUNG COMPANY
2801 Aero Park Drive, Traverse City, MI 49684 U.S.A.
Tel: 616-946-3980 Fax: 616-946-4772

Remediation Services

EMCO Process Equipment
ENSR
ERM Group Inc
Earth Remediation Services Inc
Eckenfelder Inc
Enercon Services Inc
EnsoTech Inc
Environmental Products & Services Inc
Environmental Restoration Systems
Environmental Science & Engineering Inc
Environmental Technical Services Inc
Environmental Waste Technology Inc
Excel
Flo Trend Systems Inc
SEE AD ON PAGE 64, 91
General Carbon Corp
Geo-Con
GeoTrans Inc
Grant Environmental

GESB Groundwater & Environmental Services, Inc.
800-220-3068

Groundwater & Environmental Srv Inc
Groundwater Technology Inc
Haley & Aldrich Inc

Harding Lawson Associates
SEE AD ON PAGE 34

Hazclean Environmental Consultants Inc
Heritage Environmental Services Inc
High Plains Consortium Inc
Holzmacher McLendon & Murrell PC
Horizontal Technologies Inc
Horsehead Resource Development Co Inc
Hydro Group Inc
HydroGeoLogic Inc
ICF Kaiser International Inc

Integrated Environmental Solutions Inc
SEE AD ON PAGE 35

K-F Environmental Technologies Inc
Keating Environmental Management Inc
Kruick Environmental Services Inc
Liquid Waste Technology
SEE AD ON PAGE 35, 87

Marine & Environmental Testing Inc
Maximilian Technologies Inc
Medina Agriculture Products Co Inc
Millennium Science & Engineering Inc

**MORRISON
KNUDSEN**
CONSTRUCTION
208-386-7150

Morrison Knudsen Corp
National Technical Systems
North American Environmental Corp
Northwestern Carbon
Osprey Biotechnics
P W Stephens Contractors Inc
Peoria Disposal Co
ProBios Inc
R E Wright Environmental Inc
RMT Inc
Raytheon Environmental Svcs/
Raytheon Engineers & Construction
Remediation Inc
Resources Service Intl
Resources Conservation Co
Rollins Environmental Services
Roy F Weston Inc
Serengeti Environmental

S **Sevenson
Environmental
Services, Inc.**
716-284-0431

Sevenson Environmental Services Inc
Sharp & Associates Inc
Site Reclamation Systems Inc
Soil Solutions Inc
Sverdrup Civic Inc
Sverdrup Environmental Inc
TRC Environmental Corp
SEE AD ON PAGE 32

Testwell Craig Laboratories Inc
Traverse Group, The
Vulcan Iron Works Inc
W Canning Inc

Western Water Consultants Inc
Williams Environmental Services Inc
Wonder Makers Inc

Rental Services

Advanced Data Systems
Airmetrics
American Environmental Instruments Inc
Baker Tanks Inc
CAE Instrumental Rental
Coastal Leasing Inc
Diversified Well Products Inc
Earth Remediation Services Inc
EnsoTech Inc
Environmental Recovery Resources Inc
Environmental Restoration Systems
Global Technologies
Godwin Pumps of America Inc
Hazzo Services Inc
Hertz Equipment Rental Corp

In-Situ Inc.
The Solutions People
800-446-7488

In-Situ Inc
SEE AD ON PAGE 31
Instrumentation Northwest Inc (INW)
Instruments Direct Inc
Intek Corp/Rent-Alyzer
Kekc Instruments Inc
Manning Environmental Inc
Metrosonics Inc
Northwestern Carbon
Oiland Safety
Pace Transducer Div of
CJ Instruments Inc
Portec C E D Environmental Products
Remediation Service Intl
Scott Lawson Group Inc, The
Valien Safety Supply Co

Respirometers

Anatel Corp
Arthur Technology Inc
Bioscience Inc

CEs
913-681-3913

Challenge Environmental Systems Inc
Columbus Instruments
Oiland Safety
R E Wright Environmental Inc

Reverse Osmosis Equipment

APV Anhydro-Separation Technologies
Applied Membranes Inc

DESAL
DESALINATION SYSTEMS, INC.
619-598-3334

Desalination Systems Inc
Environmental Systems Engineering Inc
GeoPure Systems & Services
Hungerford & Terry Inc
Hyde Products
Ionics Inc
Kineticco Inc/Engineered Systems Div
Millipore Corp
Osmonics Inc

SEE AD ON PAGE 25

RGF Environmental Systems Inc
S C Altman & Associates
Samsco Inc

SEE AD ON PAGE 101

Sanborn Technologies
Smith & Loveless Inc
Trisep Corp
U S Environmental Engineering Inc
United States Filter Corp

Universal Process Equipment Inc
Western Filter Co
Wheelabrator Clean Water Inc - HPD Div
Bioscience Inc

Risk Analysis

ABB Environmental Services Inc
August Mack Environmental Inc
Blasland Bouck & Lee Inc
Bovar Environmental
CDM Federal Programs Corp
CTL Environmental Services

CDM Camp Dresser & McKee Inc.
617-621-8181

Camp Dresser & McKee Inc
Century West Environmental Inc
DNV Technica

DAMES & MOORE
213-683-0471

Dames & Moore

SOFT
800-844-1400

E-Soft Inc
ELB & Associates Inc
ESSC (Earth Systems & Solutions Corp)
Eckenfelder Inc
EcoAnalysis Inc
Enercon Services Inc
EnsoTech Inc
Environmental Science & Engineering Inc
Foth & Van Dyke
GeoTrans Inc
Groundwater & Environmental
Services Inc
Groundwater Technology Inc
Haley & Aldrich Inc

PRODUCTS/SERVICES

Keeping our little corner of the world a lot cleaner.

**Advanced Hazardous Waste Treatment
Environmental Engineering Services**

**vonRoll
WTI**

East Liverpool, Ohio • 800.548.7655

*Highest Accuracy
Low Price
Intrinsically Safe!*

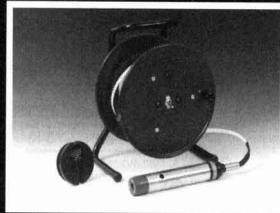

- Sturdy Model #121
- Infra-red sensor accurate to 1/20 inch, (1.3 mm)
- Measurements to 1/100 ft. or each millimeter.
- Any tape length from 50' to 1000'
- Stranded S.S. conductors do not stretch
-repairs easily and inexpensively
- Price as low as \$1595
-includes carry bag and cleaning brush

The #121 Interface Meter maintains the Solinst commitment to accuracy, and provides the precision needed for top quality down-hole analysis.

Solinst

High Quality Groundwater Instrumentation

Tel: (905) 873-2255, (800) 661-2023; Fax: (905) 873-1992

Risk Analysis

Hazclean Environmental Consultants Inc
HydroGeoLogic Inc
ICF Kaiser International Inc
Kilam Associates
Mabett & Associates Inc
National Technical Information Service
Pittsburgh Activated Carbon Services Inc
Radian Corp
Raytheon Environmental Svcs/
Raytheon Engineers & Construction
Remtech Inc
Rollins Environmental Services
Roy F Weston Inc
Terra Consulting Group Inc
Testwell Craig Laboratories Inc
Traverse Group, The
Trinity Consultants Inc
Walk, Haydel & Associates Inc
Wharton Environmental
Williams Environmental Services Inc
Yamada Science & Art Corp (YSA)

Sierra Monitor Corp
Speakman Co
Spectronics Corp
Stanley Storage Systems
TENAX Corp
Terra Universal Inc
3M Occupational Health & Environmental Safety Div
Ultra-Research Inc
UltraTech Intl Inc
Uvex Safety Inc
Vallen Safety Supply Co
Wilson Safety Products
Ziamatic Corp

Sample Containers

Art's Manufacturing & Supply
Basco Inc
Ben Meadows Co
Dival Safety Equipment
Eagle-Picher/E S A T
Entech Instruments Inc
Environmental Laboratory Services
Hazzo Safety Inc
Industrial Glassware
Meriter
Myriad Industries
North American Environmental Corp
Polytoam Packers Corp



SKS
800-899-7488

SKS Bottle & Packing Inc
Sunshine Technology Corp
Wheaton Science Products
Wonder Makers Inc

Sampling Direct Push



AM
800-635-7330

Art's Manufacturing & Supply

Sampling Screens



TIMCO
800-236-8534

Timco Manufacturing

Sampling Systems

Air Dimensions Inc
Airmetrics
American Sigma Inc
Ametek Proc & Analytical Instruments Div



AA Applied Automation
Hartmann & Brown
918-662-7343

Applied Automation
SEE AD ON PAGE 14, 120



AM
800-635-7330

Art's Manufacturing & Supply
BIOS Intl Inc



BVS 610-273-2841

BVS Inc
Baldwin Environmental Inc
Basco Inc
Ben Meadows Co
Brailsford & Co Inc
Buck Scientific Inc
Ecom America
Entech Instruments Inc
Environmental Laboratory Services
Environmental Products & Services Inc
Environmental Systems Engineering Inc
FMI Fluid Metering Inc
GeoGuard Inc
Geotech Environmental Equipment Inc
Gilan Instruments
Global Water

Instrumentation Northwest Inc (INW)
J L Rochester Co
Keck Instruments Inc



MMC
800-645-7339

MMC International Corp
SEE AD ON PAGE 24

Manning Environmental Inc
Meriter
Mil-Ram Technology Inc
Myriad Industries
North American Environmental Corp
Perkin-Elmer Corp
QED Environmental Systems Inc
SKS Bottle & Packing Inc
SRI Instruments
Scott Lawson Group Inc, The
Sensidyne Inc
United Sciences Inc
Vortex Co
Wonder Makers Inc

Screens

American Pulverizer Co



A 817-465-5611

Andritz-Ruthner Inc
Atlantic Screen & Mfg



Cedarapids
A Raytheon Company
319-363-3511

Cedarapids Inc A Raytheon Co
Conti Environmental Inc
Cook Screen Technologies Inc
Diversified Well Products Inc
Enco EMC
Envirex Inc
Enviro-Care Co



PRO TEND SYSTEMS, INC. 713-699-0152

Flo Trend Systems Inc
SEE AD ON PAGE 64, 91

Frontier Technology Inc
General Kinematics Corp
Hycor Corp
InterJet Inc.
International Reserve Equipment Corp
L & L Process Industries Inc
Lakeside Equipment Corp
Multitek Inc



PORTEC
605-665-8770

Portec C E D Environmental Products
Rotex Inc
Universal Process Equipment Inc
Waste-Tech Inc
Wheelabrator Technologies Inc

Scrubbers

AAF Intl
Advanced Air Technology Inc
Air Plastics Inc
Ambient Engineering Inc
Andersen 2000 Inc
Brown-Minneapolis Tank
Celcote Air Pollution Control
Chem-Tainer Industries



CGS
516-467-1600

Clean Gas Systems Inc
Croll Reynolds Co Inc
Davis Process Div
Delta Cooling Towers Inc
Duall Div Met-Pro Corp
Ducon Environmental Systems Inc
Global Technologies
Griffin Environmental Co Inc
HEMCO Corp
Jaeger Products Inc



MUSONIX
516-694-9555

Mosiron Inc



Monsanto Enviro-Chem
314-275-5700

Monsanto Enviro-Chem Systems Inc
Northwestern Carbon
NuTech Environmental Corp
Pego Systems Inc
Plastronics Inc
RJ Environmental Inc
Raytheon Environmental Svcs/
Raytheon Engineers & Construction
Remco Products Corp
Remedial Systems Inc
Spectra Gases Inc
United McGill Corp
Universal Process Equipment Inc
Wheelabrator Clean Air Systems Inc
Wheelabrator Technologies Inc
Zurn Air Systems

Sealants

Atlantic Screen & Mfg
Childers Products Co
Drip Free Packing Co
Legi-Flate

SEE AD ON PAGE 10, 113



Morton
312-807-2345

Morton International, Inc
PolySpec Corp
RHH Foam Systems Inc
Raven Lining Systems
Swagelok Companies, The
W Canning Inc

Secondary Containment

Aero Tec Laboratories Inc
SEE AD ON PAGE 45

American Safety Products Inc
Ameron Fiberglass Pipe
Assmann Corp of America
Atlas Minerals & Chemicals Inc
Baker Tanks Inc
Basco Inc
Bergen Barrel & Drum Co
Brown-Minneapolis Tank
Camber Corp
Chem-Tainer Industries
Clamshell Buildings Inc
Concrete Systems Inc
Containment Corp
Conti Environmental Inc
Dudick Inc
EBW Inc
Enpac Corp
Ensotech Inc
Environetics Inc
Environmental Compliance Products
Environmental Container Corp
Environmental Products & Services Inc
Environmental Tank Systems Inc (ETS)

Exploration Products
SEE AD ON PAGE 71



Fabrico 800-621-8546

Fabrico Environmental Liners Inc
George Fischer Inc
Grant Environmental

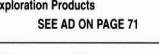

HAZ-MAT CONTAINMENT CORPORATION
800-943-6510

Haz-Mat Containment Corp

Sensors



HAZ-SAFE
Buildings by Design
412-842-2130

Haz-Safe Buildings Div of CID Assoc Inc
SEE AD ON PAGE 72, 94

Haz-Stor
SEE AD ON PAGE 45, 114

Hazco Services Inc
Highland Tank & Mfg Co
Justrite Manufacturing
Justrite Manufacturing Co LLC
MPC Containment Systems Ltd
Omega Engineering Inc
SEE AD ON PAGE 2

PND Corp
Pactec Inc
Parkline Inc
Plastic Fusion Fabricators Inc
Plastronics Inc
Plexico
Poly Processing Co
PolySpec Corp
Precision Quincy Corp
R E Wright Environmental Inc
RJ Environmental Inc
Reef Industries Inc
Safe Environmental Storage
Safety Storage Inc
SEE AD ON PAGE 39, 79

Sauereisen
Smith Fiberglass Products Inc
Stanley Storage Systems
Syntechs Inc
Total Containment
UltraTech Intl Inc
Wisconsin Protective Coat

Sedimentation Equipment

EIMCO Process Equipment
Extch Instruments
Great Lakes Environmental Inc
International Reserve Equipment Corp
Remedial Systems Inc
SRS Crisafulli Inc
Walker Process Equipment Div of McWhir Corp

Sensors

Advanced Data Systems
Advanced Sensor Devices Inc
Agar Corp Inc
Air Instruments & Measurements Inc
American City & Abatement Products Inc
Atlantic Screen & Mfg
BTG Div of Spectris Technologies Inc
Bacharach Inc
Bailey Controls Co
Blue-White Industries
Boston Gear
CSA Instruments Inc
Campbell Scientific Inc
Civacon
Climatronics Corp
SEE AD ON PAGE 110

Coastal Environmental Systems
Control Instruments Corp
Detcon Inc
Dival Safety Equipment
Drexelbrook Engineering Co
Dwyer Instruments Inc
EBW Inc
EPG Companies
Electrosynthesis Co Inc
Enviro-Map Inc
Environmental Systems Engineering Inc
FCI Environmental Inc
Fluid Components Intl
Gas Tech Inc
Gem Sensors Div
Global Water
Handar
Helima Cells Inc
HydroLab Corp
SEE AD ON PAGE 40, 118



Innovative Sensors, Inc.
800-835-5474

Innovative Sensors Inc
Instrumentation Northwest Inc (INW)
International Sensor Technology
Lundahl Instruments Inc

Rupture Disks

Duvsent Inc
Fike Metal Products

Safety Equipment & Products

AGA Gas Inc
Allegro Industries
Amibi-Tech Safety Brakes
American Environmental Instruments Inc
American City & Abatement Products Inc
AramSCO
Argus Environmental Monitoring
BGI Inc
Basco Inc
Bay Marketing
Ben Meadows Co
Bergen Barrel & Drum Co
Biomarine
CEA Instruments Inc
Cabot Safety Corp
Capital Controls Co Inc
Columbia Scientific
Containment Corp
Custom Switches
David Clark Co Inc
Direct Safety Co
Dival Safety Equipment
Diversified Well Products Inc
Enmet Corp
Environmental Compliance Products
Environmental Products & Services Inc
Exploration Products

SEE AD ON PAGE 71

Fike Metal Products
First Fabrics Inc
Gemtor Inc
Gilan Instruments
HEMCO Corp
Haws Drinking Faucet Co
Haz-Mat Containment Corp
Hazzo Services Inc
International Safety Instruments
Justrite Manufacturing
Justrite Manufacturing Co LLC
Lapeyre Stair Inc
Magid Glove & Safety Mfg Co
Moldex-Metric Inc
Myriad Industries
NUS Training Corp
National Draeger Inc
National Marker Co
Neoterik Health Technologies Inc
Network Environmental Systems Inc (NES)

New Pig Corp

SEE AD ON PAGE 49, 99

Niffick of America Inc
North Safety Products -
Hand Protection Div
North Safety Products, Safety
Equipment Div
North Safety Products
Oilind Safety
Pactec Inc
RKI Instruments Inc
Racal Health & Safety Inc
Remco Products Corp
Revere Products Inc
Safety Storage Inc

SEE AD ON PAGE 39, 79

Scott Specialty Gases
Sensidyne Inc
Shields Environmental Corp

THE FIRST GC/MS DESIGNED FOR SITE SEEING.



Introducing HAPSITE™, the first portable GC/MS that lets you see the answers before you leave the site.

VOHAPs analysis just got easier, and quicker, and less expensive, and less time consuming, and more reliable.

No, it's not too good to be true. It's what the industry has been waiting for—the first truly field-portable instrument to provide on-site analysis of VOHAPs.

HAPSITE literally changes the way VOHAPs analysis is done. Battery-powered, lightweight and weatherproof, this new instrument will accurately speciate and quantify VOC emissions right on the spot, giving you the certainty that your field crew will only have to test once.

And it's easy to use. HAPSITE doesn't require any special knowledge of mass spectrometry, because an internal processor interprets and displays

the results. It's self-tuning, too, so the field operator doesn't tune or calibrate the GC/MS. Using built-in internal standards, HAPSITE ensures accurate calibration for greater confidence in test results.

HAPSITE also offers total flexibility for multiple applications. It can be used in a survey mode (MS only) for fast screening, or in a GC/MS mode when confirmatory results are required. In either mode, it has full scan or SIM capability.

And it's *only* available from Inticon, a world leader in the design and manufacture of analytical instruments.

If you're involved in VOHAPs analysis, now you can spend a lot less time site seeing.

Call 1-800-223-0633 for more information.

REGISTERED
ISO 9001
MAY 1993

OPENING THE FIELD TO NEW IDEAS™

INFICON®

Sensors

MKS Instruments Inc
McNeill Intl

508-486-9800
Metritape

Metritape Inc

541-471-7111
Met One Instruments

Met One Instruments Inc

SEE AD ON PAGE 43, 85

Miltronics Inc
Monarch Instrument
National Draeger Inc
Novalyx Corp
Phonetics Inc
RKI Instruments Inc
Remtech Inc
S J Electro Systems Inc
Schneider Instrument Co
Sensidyne Inc

Spectra Gases Inc
Transducer Research Inc
U S Industrial Products Co Inc
Ultra-Research Inc
Vaisala Inc
Vallen Safety Supply Co
YSI Inc

Separation Systems

APV Anhydro-Separation Technologies
Aeration Industries Intl Inc
Alfa Laval Sharpies,
Alfa Laval Separation Inc
Alternative Remedial Technologies Inc
Andritz-Ruthner Inc
Ashbrook Corp
Baler Equipment Co
Bird Machine Co Inc
Camber Corp
ChromatChem Inc
Davco Div Davis Water & Waste
Industries Inc
Dustvent Inc
EIMCO Process Equipment

Environmental Products & Services Inc
Environmental Recovery Resources Inc
Environmental Systems Engineering Inc
Global Equipment Marketing Inc
Hudson Industries
Hyde Products
International Reserve Equipment Corp
JWI
Krebs Engineers Inc
Mazzei Injector Corp
Megator Corp
Microphor Inc
Multitek Inc
National Fluid Separators
Norton Chemical Process Products Corp
Oil Skimmers Inc
Osmonics Inc

SEE AD ON PAGE 25

Perkin-Elmer Corp
Remedial Systems Inc
Remediation Service Intl
Samsco Inc

SEE AD ON PAGE 101

Sanborn Technologies
Shred-Tech

Spencer Turbine Co. The
Treatment Technologies
United States Filter Corp

Separators

C G S
516-467-1600

ACS Industries Inc
Alfa Laval Sharpies,
Alfa Laval Separation Inc
Andritz-Ruthner Inc
Ashbrook Corp
Baler Equipment Co
Bird Machine Co Inc
CINC

SEE AD ON PAGE 25

Camber Corp

C G S
516-467-1600

Clean Gas Systems Inc
Davco Div Davis Water &
Waste Industries Inc
Dustvent Inc
Envirex Inc
Environmental Products & Services Inc
Environmental Recovery Resources Inc
Environmental Systems Engineering Inc
Flo Trend Systems Inc

SEE AD ON PAGE 64, 91

Frontier Technology Inc
Global Equipment Marketing Inc
Great Lakes Environmental Inc
Grissold Controls
Hankison Intl
Highland Tank & Mfg Co
Hudson Industries
Hyde Products
International Reserve Equipment Corp
Krebs Engineers Inc
Mazzei Injector Corp
McTighe Industries Inc
Megator Corp
Microphor Inc
Oil Skimmers Inc
Pactec Inc
Parker Hannifin Corp
R P Adams Co Inc
Remedial Systems Inc
Rotex Inc
Sanborn Technologies
Smith & Lovelace Inc
Spencer Turbine Co. The
U S Environmental Engineering Inc
Universal Process Equipment Inc
W Canning Inc
Zimpro Environmental Inc

Septic Tanks

Chem-Tainer Industries
Infiltrator Systems Inc
M L E
Plastronics Inc
W Canning Inc

Sequencing Batch Reactors

Davco Div Davis Water &
Waste Industries Inc
Environmental Tank Systems Inc (ETS)
Purstream Inc
United States Filter Corp

Settling Chambers

Burns & McDonnell Waste
Consultants Inc
Suburbia Systems Corp
Western Filter Co

Sewage/Sludge Disposal Equipment/Services

ABB Air Preheater Inc Raymond Prods
AMSCO Inc
Aeration Industries Intl Inc

Shelters

612-933-9006
ag-chem

Ag-Chem Equipment Co Inc
Baler Equipment Co
BioGro Div Wheelabrator
Clean Water Systems Inc
Bioscience Inc
Brown & Caldwell
Brown Bear Corp
CEA Instruments Inc

CDM Camp Dresser & McKee Inc.
617-621-8181

Camp Dresser & McKee Inc
Chemical Lime Co
Chester Environmental
College Research Corp (CORECO)
Conti Environmental Inc
Davis Process Div
DeMarco MAX VAC Corp
Ducon Environmental Systems Inc
EIMCO Process Equipment
Environmental Science & Engineering Inc
Hankin Environmental Systems Inc
Horshead Resource Development Co Inc
IMS Inc (Innovative Material Systems Inc)
International Reserve Equipment Corp
JWI
K-F Environmental Technologies Inc
Kilam Associates
Liquid Waste Technology
SEE AD ON PAGE 65

M L E
Metcalf & Eddy
Millennium Science & Engineering Inc
Probiotic Solutions
R E Wright Environmental Inc
Raytheon Environmental Svcs/
Raytheon Engineers & Construction
Remediation Inc
Sewall, James W
Sharp & Associates Inc
Somat Corp
Superior Special Services Inc
Sverdrup Environmental Inc
TRC Environmental Corp
SEE AD ON PAGE 32
Universal Process Equipment Inc
Wheelabrator Technologies Inc
Williams Environmental Services Inc

Sewage Transport Systems

AMSCO Inc
Braun Intertec Corp
Chester Environmental
M L E
Sharp & Associates Inc
Superior Special Services Inc
Sverdrup Civic Inc
Wheelabrator Technologies Inc

Sewage Treatment Equipment

EnviroQuip International Inc

Sewage Systems, Vacuum

Baler Equipment Co
DeMarco MAX VAC Corp
Environmental Technical Services Inc
Sharp & Associates Inc
Superior Special Services Inc

Sewer Inspection TV System

CEA Instruments Inc
Chester Environmental
Environmental Technical Services Inc
R E Wright Environmental Inc
Sewall, James W
Sharp & Associates Inc
Superior Signal Co Inc
Sverdrup Environmental Inc

Shelters

A&J Environmental Supply
C H Hanson Co, The
Camber Corp

IF YOU MUST KNOW WATER QUALITY... YOU MUST KNOW HYDROLAB.

temperature
dissolved oxygen
sp. conductance
conductivity
pH
turbidity
salinity
resistivity
depth/level
TDS
redox
ammonium - NEW!



Are you the expert on your lake, river, bay, or estuary?

Hydrolab will help you know more about your body of water than anyone else in the world. We can do this because we know more than anyone else about the water quality monitoring instruments required for this job.

No matter what the application - freshwater, seawater, groundwater, wastewater, tanks, or aquaria, there is a Hydrolab Multiprobe (all-in-one sensor package) to get you the data you need, with minimum effort and maximum reliability.

CALL 800-949-3766.



Hydrolab Corporation • P.O. Box 50116 • Austin, TX 78763
Telephone 800-949-3766 or 512-255-8841 • FAX 512-255-3106

Helping preserve our world's water resources

Shelters

Ciamshell Buildings Inc
Concrete Systems Inc
Environmental Compliance Products
Exploration Products
SEE AD ON PAGE 71

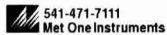

Met One Instruments Inc
SEE AD ON PAGE 43, 85

Novalynx Corp
Parkline Inc
Plast-Fab Inc
Rubb Building Systems
Shields Environmental Corp

Shredders

Ameni-Shred Corp
American Pulverizer Co
Baler Equipment Co
Blower Application Co Inc
Conti Environmental Inc
JWC Environmental
Jeffrey/Indresco
L & L Process Industries Inc
Mid-States Recycling Systems Inc
Multitek Inc
Portec C E D Environmental Products
Prodeva Inc
S & G Enterprises Inc
SSI Shredding Systems Inc
Saturn Shredders Div of MAC Corp
Shred-Tech
Universal Engineering

Signal Conditioners

Acromag Inc
Burns & McDonnell Waste
Consultants Inc
Climatronics Corp
SEE AD ON PAGE 110
Keithley Metrabyte
Omega Engineering Inc
SEE AD ON PAGE 2
Pace Transducer Div of
CJ Instruments Inc
Sierra Monitor Corp

Silencers/Mufflers

AAF Intl
BRD Noise & Vibration Control Inc
DeMarco MAX VAC Corp
Dustvent Inc
United McGill Corp

Site Assessment

AAA Environmental
ABB Environmental Services Inc
Adronack Environmental Associates Inc
Adrian Brown Consultants Inc
Allied Environmental Consultants Inc
Alton Geoscience Inc
August Mack Environmental Inc
Blasland Bouck & Lee Inc
Bovar Environmental
Braun Intertec Corp
Brown & Caldwell
CDM Federal Programs Corp
CTL Environmental Services

CDM Camp Dresser & McKee Inc.
617-621-8181

Camp Dresser & McKee Inc
Century West Environmental Inc
Clean World Engineering Ltd
Con-Test/ATC Environmental Inc
Cura Inc
Dames & Moore
ELB & Associates Inc
ESSC (Earth Systems & Solutions Corp)
Eckenfelder Inc
Enviro-Map Inc
Environmental Compliance Products
Environmental Data Resources Inc
Environmental Resource Center
Environmental Risk Information & Imaging Services ERIIS

Environmental Science & Engineering Inc
Foth & Van Dyke
GoTrans Inc
Graef, Anhalt, Schloemer & Associates Inc
Grant Environmental
Groundwater & Environmental
Services Inc
H H Burkitt Project Mgmt Inc
Haley & Aldrich Inc
Harding Lawson Associates

SEE AD ON PAGE 34
Hazclean Environmental Consultants Inc
Heritage Environmental Services Inc
High Plains Consortium Inc
Horsehead Resource Development Co Inc
Hydro Group Inc
Jaca Corp
Keating Environmental Management Inc
Killam Associates

Kruck Environmental Services Inc
Lexicon Environmental Associates Inc
Mabbett & Associates Inc
Marine & Environmental Testing Inc
Micro Analytical Laboratories Inc
Morrison Knudsen Corp
Pittsburgh Activated Carbon Services Inc
QED Environmental Systems Inc
R E Wright Environmental Inc
Radian Corp
Raytheon Environmental Svcs/
Raytheon Engineers & Construction
Rollins Environmental Services
Roy F Weston Inc
S W Cole Engineering Inc
SSOE Inc
Scott Lawson Group Inc, The
Sensidyne Inc
Sewall, James W
Shields Environmental Corp

SITE-ASSESSMENT
Software
800-365-3962

Site Assessment Software
Sverdrup Environmental Inc
TRC Environmental Corp

SEE AD ON PAGE 32
Terra Consulting Group Inc
Testwell Craig Laboratories Inc
Traverse Group, The
Walk, Haydel & Associates Inc
Western Water Consultants Inc
Williams Environmental Services Inc
Wonder Makers Inc
Yamada Science & Art Corp (YSA)

Sludge Blanket Level

BTG Div of Spectris Technologies Inc
Montek Technologies Inc
Sharp & Associates Inc

Sludge Concentrating Equipment

A 817-465-5611
AMSCO

Andritz-Ruthner Inc
Baker Tanks Inc
EIMCO Process Equipment
Flo Trend Systems Inc

SEE AD ON PAGE 64, 91
Heyl & Patterson Inc Renneburg Div
Industrial Filter & Pump Mfg Co
International Reserve Equipment Corp
K-F Environmental Technologies Inc
Resources Conservation Co
Smith & Loveless Inc
Somat Corp
Tenco Hydro Inc
Universal Process Equipment Inc
Western Filter Co

Sludge Dewatering/Disposal Service

AMSCO Inc
Alton Geoscience Inc
Ashbrook Corp
BioGro Div Wheelabrator
Clean Water Systems Inc

Brown & Caldwell
Burns & McDonnell Waste
Consultants Inc
Chester Environmental
Conti Environmental Inc
Conti Environmental Inc
EIMCO Process Equipment
Environmental Technical Services Inc
Heritage Environmental Services Inc
Horsehead Resource Development Co Inc
K-F Environmental Technologies Inc
Laidlaw Environmental Services
Rollins Environmental Services

S **Sevenson**
Environmental
Services, Inc.
716-284-0431

Sevenson Environmental Services Inc
Sharp & Associates Inc
Smith & Loveless Inc
Soil Solutions Inc
Sverdrup Environmental Inc

Vulcan Iron Works Inc
Wheelabrator Technologies Inc
Wheelabrator Water
Technologies Inc Bio Gro Div

Sludge Dewatering Equipment

ABB Air Preheater Inc Raymond Prods
AFL Industries Inc
AMSCO Inc
Alfa Laval Sharpies,
Alfa Laval Separation Inc

A 817-465-5611
AMSCO

Andritz-Ruthner Inc
Ashbrook Corp
Baler Equipment Co
Bird Machine Co Inc
Brown Bear Corp
College Research Corp (CORECO)

Sludge Dewatering Equipment

DIAGENEX
Waste Water Systems Plus A Better Way
510-606-5600

Diagenex Inc
Durrion Co Inc
EIMCO Process Equipment
Edson Intl
Envirex Inc
Environmental Technical Services Inc
FKC Co Ltd

NO FIBER
PTFE, INC. 713-699-0152

Flo Trend Systems Inc
SEE AD ON PAGE 64, 91

Frontier Technology Inc
Great Lakes Environmental Inc
Heyl & Patterson Inc Renneburg Div
Hycor Corp
Industrial Filter & Pump Mfg Co
International Reserve Equipment Corp

PRODUCTS/SERVICES

THE SMARTEST VALUE IN REGULATORY COMPLIANCE

We give you more for less.

Other companies price their environmental and safety regulatory databases modularly—with separate pricing for EPA, OSHA and DOT CFRs, as well as for the *Federal Register* and state coverages.

The FESA Regulatory Compliance CD-ROM from CPI puts everything you need into one CD-ROM.

No surprises. No extra charges. One CD-ROM, one price.

Everything you need from EPA, OSHA, DOT—and more

FESA gives you the full-text *Federal Register*, including Final and Proposed Rules, Notices, Preambles and Consent Decrees, plus a minimum 18 months of archived FR data—cross-referenced with multiple CFR titles (10, 21, 29, 30, 33, 40, 49 and others). If it's in the *Federal Register*, you'll find it in FESA!

FESA also contains state coverages, and over 40 regulatory compliance manuals, including those for OSHA, EPA, RCRA, TSCA, SW-846. Quarterly, bimonthly and monthly subscriptions include CPI's biweekly *EH&S* newsletter at no extra cost. And NIOSH and AP-42 CD-ROMs are now available.

No other database is as easy to use

FESA allows you to automatically import all data—text and tables—into any popular wordprocessing software, with no reformatting. And with keyword searching, hypertext linking and WYSIWYG viewing, access to FESA data is quick and easy.

No risk 30-day trial

Try FESA for 30 days. If you're not fully satisfied, just return the CD-ROM, with the invoice marked "canceled," with no obligation.



DOS • WINDOWS • WINDOWS 95 • NETWORK
800-808-3372

Citation Publishing, Inc. • 1435 N. Hayden Rd. • Scottsdale, AZ 85257 • 602.994.4560 • Fax 602.994.4456



When it comes to gas or liquid composition, our reputation for analysis in on the line

On-line analysis of process gas or liquid composition demands innovative analytical techniques, robust sampling systems, and durable instrument packaging. For decades, Applied Automation / Hartmann & Braun have provided thousands of process analytical measurement solutions to the hydrocarbon processing industry.

We have the products and systems—including process gas chromatograph, process FTIR, process infrared, ultraviolet, thermal conductivity and paramagnetic oxygen analyzers, BTU/CV transmitters, sample conditioning systems and shelters.

We have the know-how— to provide complete engineering for applications in product purity, fractionation control, boiler control and stack gas emissions. Our solutions include motor fuels characterization, hydrocarbons in water, calorific value measurement, and CEMS, to name a few.

For more information, contact:

Applied Automation/Hartmann & Braun
P.O. Box 9999
Bartlesville, OK 74005
Phone: (918) 662-7000
Fax: (918) 662-7052

Sludge Dewatering Equipment

JWI
K-F Environmental Technologies Inc
Larox Inc
MEC Co
Netsch Inc
Or-Tec Inc
PACO Pumps
Pactec Inc
Resources Conservation Co
Seghers Dinamec Inc



Sevenson Environmental Services Inc
Smith & Lovelace Inc
Somat Corp
Star Systems Filtration Div/Hilliard of South Carolina



Stord Inc
Tarby of Delaware Inc
U S Environmental Engineering Inc
United States Filter Corp
Universal Process Equipment Inc
Waste-Tech Inc
Wheelabrator Technologies Inc
Zimpro Environmental Inc

Sludge Management

AMSCO Inc
August Mack Environmental Inc
BioGro Div Wheelabrator Clean Water Systems Inc
Blasland Bouck & Lee Inc
Bovar Environmental
Camp Dresser & McKee Inc
Chemical Safety Corp
Chester Environmental
Dames & Moore
Davis Process Div
EPM Group Inc
Edson Int'l
Environmental Science & Engineering Inc
Foth & Van Dyke
Godwin Pumps of America Inc
Hazen & Sawyer
Heritage Environmental Services Inc
Horsehead Resource Development Co Inc
K-F Environmental Technologies Inc
Killam Associates



Liquid Waste Technology
SEE AD ON PAGE 65
Metcalf & Eddy



Niro Inc
Plastic Fusion Fabricators Inc
Probiotic Solutions
R E Wright Environmental Inc
RMT Inc
SRS Cirusfalli Inc



Sevenson Environmental Services Inc
Sharp & Associates Inc
Soil Solutions Inc
Sverdrup Environmental Inc
Wheelabrator Technologies Inc
Wheelabrator Water Technologies Inc Bio Gro Div

Sludge Solidification

Alton Geoscience Inc
Andritz-Ruthner Inc
August Mack Environmental Inc
Bioscience Inc
Blasland Bouck & Lee Inc
Chester Environmental

College Research Corp (CORECO)
Colloid Environmental Technologies Co
Conti Environmental Inc
Crown Technology Inc
Clyde Industries Inc
Eckenfelder Inc
Geo-Con
Heritage Environmental Services Inc
Heyl & Patterson Inc
Renneburg Div Industrial Filter & Pump Mfg Co
RMT Inc
Seghers Dinamec Inc



Sevenson Environmental Services Inc
Sharp & Associates Inc
Soil Solutions Inc
Somat Corp
Williams Environmental Services Inc
Zimmerman Industries Inc

Slurry Cut-off Walls

Alton Geoscience Inc
August Mack Environmental Inc
Conti Environmental Inc
Dames & Moore
Eckenfelder Inc
Geo-Con
Haley & Aldrich Inc
Heritage Environmental Services Inc
R E Wright Environmental Inc
RMT Inc
Raytheon Environmental Svcs/
Raytheon Engineers & Construction



Sevenson Environmental Services Inc

Soil Gas/Groundwater Surveys

Adirondack Environmental Associates Inc
Adrian Brown Consultants Inc
Allied Environmental Consultants Inc
Alton Geoscience Inc
American Environmental Instruments Inc
August Mack Environmental Inc
Blasland Bouck & Lee Inc
Blymyer Engineers Inc
Bovar Environmental
Braun Intertec Corp
Brown & Caldwell
CDM Federal Programs Corp
CEA Instruments Inc
CTL Environmental Services



Camp Dresser & McKee Inc
Century West Environmental Inc
Chester Environmental
Clean World Engineering Ltd
Con-Tes/ATC Environmental Inc
Cura Inc
Dames & Moore
EPM Group Inc
ESSC (Earth Systems & Solutions Corp)
Earth Remediation Services Inc
Eckenfelder Inc
Eneron Services Inc
EnsoTech Inc
Enviro-Map Inc
FCI Environmental Inc
Foth & Van Dyke
GeoGuard Inc
GeoTrans Inc
Groundwater & Environmental Sv Inc
Haley & Aldrich Inc
Hazelclean Environmental Consultants Inc
High Plains Consortium Inc
Holzmacher McLendon & Murrell PC
HydroGeoLogic Inc
Integrated Environmental Solutions Inc
SEE AD ON PAGE 35, 87
Keck Instruments Inc
Kuck Environmental Services Inc

Mabbett & Associates Inc
Neri LLC
Pacific Environmental Services Inc
SEE AD ON PAGE 56, 88
R E Wright Environmental Inc
Rollins Environmental Services
Roy F Weston Inc
Sharp & Associates Inc
Sverdrup Environmental Inc
TRC Environmental Corp
SEE AD ON PAGE 32
Testwell Craig Laboratories Inc



Tracer Research Corp
SEE AD ON PAGE 41
Williams Environmental Services Inc

Soil Sampling Equipment

Alton Geoscience Inc
American Environmental Instruments Inc



Art's Manufacturing & Supply
Boart Longyear Co
Clemons Associates Inc
Dames & Moore
ELE Intl Inc/Soiltest Products Div
Enviro-Map Inc
Environmental Science & Engineering Inc
GeoGuard Inc
Hazo Services Inc
Intek Corp/Rent-Alyzer
Intervac
Midwest Laboratories Inc
Myron L Co
National Draeger Inc
Northwest Environmental Services
Testing & Training
Omega Engineering Inc
SEE AD ON PAGE 2
R E Wright Environmental Inc

Solvent Recovery Systems

SKS Bottle & Packing Inc
Sensidyne Inc
Wonder Makers Inc

Solvent Recovery Systems

ABB Air Preheater Inc
Raymond Prods
AGA Gas Inc
APV Anhydro-Separation Technologies
Airex Corp
Alfa Laval Sharples,
Alfa Laval Separation Inc
Alton Geoscience Inc
Ashland Chemical Co
SEE AD ON PAGE 7
August Mack Environmental Inc



Barnebey & Sutcliffe Corp
CINC
SEE AD ON PAGE 25
Calgon Carbon Corp

PRODUCTS/SERVICES

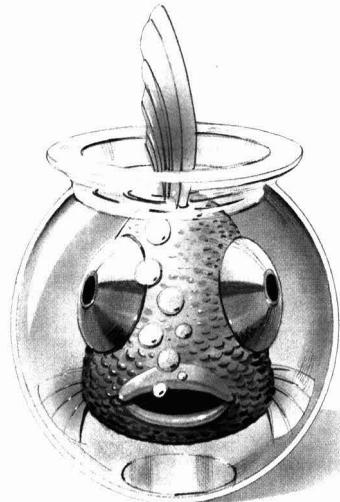

The Big Fish in
water and wastewater operation,
maintenance and management.

It's no fish story, really. The truth is, more communities across the country depend on Professional Services Group, Inc. (PSG) for contract operation, maintenance and management of their water and wastewater treatment facilities than any other company.

We operate more facilities than any national competitor. PSG dominates that market with 58% of plants greater than 10 MGD. Our closest national competitor has 15%. In fact, for facilities larger than 50 MGD, PSG outdistances our competition 3 to 1.

Impressive facts. However, the main reasons municipalities hire us are reliable, high quality and cost-effective services. Those are the best reasons for choosing PSG.



Your water and wastewater partner

14950 Heathrow Forest Parkway, Suite 200 • Houston, TX 77032
(713) 449-1500 fax (713) 449-5970

COPYRIGHT ©1995 PSG. ALL RIGHTS RESERVED.

Solvent Recovery Systems

Cameron Environmental Inc
Clean Harbors Environmental Services Inc
Dedert Corp
Ducon Environmental Systems Inc
Environmental Recovery Resources Inc
Flair
Franco Environmental Technologies
General Carbon Corp
Horba Instruments Inc
Intec Controls
Intervac
Krebs Engineers Inc
Mazzei Injector Corp
Membrane Technology & Research Inc
Met-Pro Corp Systems Div
NUCON Intl Inc
OI Analytical
ORS Environmental Systems
Osmonics Inc
SEE AD ON PAGE 25
Paragon Environmental Systems Inc
Pego Systems Inc



Praxair Inc
QED Environmental Systems Inc
RMT Inc
SRS Industrial Engineering Inc



Safety-Kleen Corp
Samsco Inc
SEE AD ON PAGE 101
Servomex Co Inc
Solvent Recovery Systems Inc
U S Environmental Engineering Inc
Universal Process Equipment Inc



Vara Intl Div of Calgon Carbon Corp
Waste-Tech Inc
Weatherly Inc
Wheelabrator Clean Air Systems Inc
Wheelabrator Technologies Inc
Xchanger Inc

Sonic Cleaning Devices

Misonix Inc
Structure Probe Inc/SPI Supplies

Speed Reducers



A & J Management Resources Inc



Applied Automation
SEE AD ON PAGE 14, 120
Boston Gear
Sumitomo

Spill Control Equipment/Products/Services

Abanaki Corp Oil Skimmer Div
Adirondack Environmental Associates Inc
Agar Corp Inc



Art's Manufacturing & Supply
Basco Inc
Bergen Barrel & Drum Co
Blymeyer Engineers Inc
Boyer Environmental
Burns & McDonnell Waste Consultants Inc
CDM Federal Programs Corp

CEA Instruments Inc
Chem-Tainer Industries
Ciracon
Comco Inc
Containment Systems
Cura Inc
DeMarco MAX VAC Corp
Direct Safety Corp
Drexelbrook Engineering Co
Bruel & Kjaer Instruments Inc
Enpac Corp
Environmental Compliance Products
Environmental Container Corp
Environmental Products & Services Inc
Environmental Science & Engineering Inc
GeoTrans Inc
Godwin Pumps of America Inc
Groundwater Technology Inc
HEMCO Corp
Haz-Stor
SEE AD ON PAGE 45, 114

Heritage Environmental Services Inc
Hudson Industries
Hyde Products
ILC Dover Inc
International Reserve Equipment Corp
Justrite Manufacturing Co LLC
Magid Glove & Safety Mfg Co
Maxymillian Technologies Inc
New Pig Corp
SEE AD ON PAGE 49, 99

OPW Fueling Components
Oil Skimmers Inc



502-776-7776

P & D Systemteknik
PND Corp
Pactec Inc
Petrol REM Inc
R E Wright Environmental Inc
Reef Industries Inc
Remco Products Corp
Remediation Inc
Rite in the Rain Fieldbooks
Rusmar Inc
Safe Environmental Storage
Sensidyne Inc
Sharp & Associates Inc
Shields Environmental Corp
Skolnik Industries Inc
Slikbar Products Corp
Slikwik Sorbents
Spectrogram Corp
Sunshine Technology Corp
SynTechnics Inc
TRC Environmental Corp
SEE AD ON PAGE 32

3M Co (Performance Chemicals)
3M Occupational Health & Environmental Safety Div
U S Best
UltraTech Intl Inc
Upright Inc
Vallen Safety Supply Co
Wolfco Group Inc

Spraying Equipment

AMSCO Inc
Armsco
Chemco Manufacturing Co Inc
Cushman
Finn Corp
Hazardous Environmental Consultants Inc
Hazzo Services Inc
Remediation Service Intl
SRS Industrial Engineering Inc
Spraying Systems Co

Stack Emission Monitors

Advanced Pollution Instrumentation Inc
Air Instruments & Measurements Inc
American Environmental Instruments Inc
Ametek Process & Analytical Instruments Div
Anarid Inc
Argus Environmental Monitoring



Auburn International Inc
SEE AD ON PAGE 69

Bailey Controls Co
Baldwin Environmental Inc
Bovar Environmental
Bruel & Kjaer Instruments Inc
Clean Air Engineering
Dyna-FID Inc



EMS Environmental Monitor Service
Ecom America
Energy Efficiency Systems Inc
Environics Inc
Fluid Components Intl
Graseby
SEE AD ON PAGE 15, 89

Horiba Instruments Inc
Inficon Inc
SEE AD ON PAGE 117, 164
Intek Corp/Rent-Alyzer
Jaca Corp
KVA/Analect
Land Combustion



MSI Mechanical Systems Inc
McNeill Intl



Mil-Ram Technology Inc
Perkin-Elmer Corp
Photovac Monitoring Instruments
SEE AD ON PAGE 51, 57
R E Wright Environmental Inc
Rosemont Analytical Inc
SRI Instruments
Servomex Co Inc
Shimadzu Scientific Instruments Inc
Siemens Energy & Automation Inc
TRC Environmental Corp
SEE AD ON PAGE 32

Testo Inc
SEE AD ON PAGE 72
Testwell Craig Laboratories Inc
Ultra Sciences Inc
Wheelabrator Clean Air Systems Inc
Zellweger Analytics Inc

Stack Emission Testing



AirNova Inc



Applied Automation
SEE AD ON PAGE 14, 120

August Mack Environmental Inc
Bacharach Inc
Bovar Environmental
Braun Interlec Corp
Brown & Caldwell
CTL Environmental Services
Clean Air Engineering
Clean World Engineering Ltd
Cura Inc
ERM Group Inc
Enercon Services Inc
Energy Efficiency Systems Inc
Entech Instruments Inc
Entropy Inc
Environics Inc
IHS Regulatory Products - EarthLab
K & B Design Inc
Kilam Associates
MMT Environmental Services Inc
Mabbett & Associates Inc



Metco Environmental
Midwest Laboratories Inc
OI Analytical
Pace Inc
Pacific Environmental Services Inc
SEE AD ON PAGE 56, 88

Perkin-Elmer Corp
R E Wright Environmental Inc
RAMCON Environmental Corp
RMT Inc
Raytheon Environmental Svcs/
Raytheon Engineers & Construction
Roy F Weston Inc
TRC Environmental Corp
SEE AD ON PAGE 32



Tenerx Corp
Tetco Inc
SEE AD ON PAGE 72
United Sciences Inc

Stack Flow Meters

Clean Air Engineering
Fluid Components Intl
Omega Engineering Inc
SEE AD ON PAGE 2
United Sciences Inc

Standards

AccuStandard Inc
Analytical Products Group Inc
Chem Service Inc
Entech Instruments Inc
Environmental Resource Associates



LabChem Inc
NIST - Standard Reference Materials
NISI Environmental Solutions Inc
Ricca Chemical Co



Spectra Gases Inc
Taylor Technologies Inc
ULTRA Scientific
VICI Metronics Inc

Sterilizers

Brinkmann Instruments Inc
Universal Process Equipment Inc

Stormwater Monitoring

ABB Environmental Services Inc
Cargill Corp Inc
Allied Environmental Consultants Inc
Allton Geoscience Inc
American Sigma Inc
August Mack Environmental Inc
Blasiand Bouck & Lee Inc
Blymeyer Engineers Inc
Boyar Environmental
Brown & Caldwell
CDM Federal Programs Corp
CTL Environmental Services



Camp Dresser & McKee Inc
Campbell Scientific Inc
Chemetrics Inc
Cura Inc
Dames & Moore
ERM Group Inc
ESSO (Earth Systems & Solutions Corp)
Eckelfelder Inc
Enercon Services Inc

Stormwater Treatment

EnsoTech Inc
Environmental Education Enterprises E3
Environmental Products & Services Inc
Environmental Resource Center
Environmental Technical Services Inc
FCI International Inc
Foth & Van Dyke
Grant Environmental
Groundwater & Environmental Services Inc
Groundwater Technology Inc
Hach Co
Harding Lawson Associates
SEE AD ON PAGE 34

Hazco Services Inc
Hazen & Sawyer
Heritage Environmental Services Inc
High Plains Consortium Inc
Horiba Instruments Inc
In-Situ Inc
SEE AD ON PAGE 31
Intec Controls
Ionics Inc
Iso Inc Environmental Div
Keck Instruments Inc
Killam Associates
Mabbett & Associates Inc
Manning Environmental Inc
Myriad Industries
National Technical Information Service
Novalyx Corp
Omega Engineering Inc
SEE AD ON PAGE 2

Pacific Environmental Services Inc
SEE AD ON PAGE 56, 88
R E Wright Environmental Inc
RMT Inc
Raytheon Environmental Svcs/
Raytheon Engineers & Construction
Rite in the Rain Fieldbooks
Rollins Environmental Services
Roy F Weston Inc
SERCO Laboratories
SRI Instruments
Schneider Instrument Co
Seawall, James W
Sharp & Associates Inc
Solomat - Neotronics
Spectrogram Corp
Sverdupr Civic Inc
Sverdupr Environmental Inc
TRC Environmental Corp
SEE AD ON PAGE 32
Testwell Craig Laboratories Inc
Traverse Group, The



Turner Designs Inc
SEE AD ON PAGE 21, 83
Western Water Consultants Inc
Zellweger Analytics Inc

Stormwater Treatment

ABB Environmental Services Inc
Aeration Industries Intl Inc
Allied Environmental Consultants Inc
Allton Geoscience Inc
American Technologies Group Inc
Andoo Environmental Processes Inc
Blasiand Bouck & Lee Inc
Blymeyer Engineers Inc
Boyar Environmental
Brown & Caldwell
CDM Federal Programs Corp
CSF Treatment Systems Inc
Camp Dresser & McKee Inc
Dames & Moore
ECO Purification Systems USA Inc
Eckelfelder Inc
Enercon Services Inc
EnsoTech Inc
Environmental Education Enterprises E3
Environmental Recovery Resources Inc
Flo Trend Systems Inc
SEE AD ON PAGE 64, 91

Foth & Van Dyke
Franco Environmental Technologies
GeoPure Systems & Services
Grant Environmental
Groundwater Technology Inc
Hazen & Sawyer
Heritage Environmental Services Inc
Highland Tank & Mfg Co
Hudson Industries

Stormwater Treatment

Hycor Corp
Hyde Products
Infiltrator Systems Inc
Kilam Associates
Landa Water Cleaning Systems
M LE
Mabbett & Associates Inc
Mazze Injector Corp
Millennium Science & Engineering Inc
National Technical Information Service
Oil Skimmers Inc

Omega Engineering Inc

SEE AD ON PAGE 2

Plasti-Fab Inc
R E Wright Environmental Inc
RMT Inc
Raytheon Environmental Svcs/
Raytheon Engineers & Constructors
Remedial Systems Inc
Rollins Environmental Services
Roy F Weston Inc
SERC0 Laboratories
Samsco Inc

SEE AD ON PAGE 101

Sharp & Associates Inc
Smith & Loveless Inc
Sverdrup Civic Inc
Sverdrup Environmental Inc
TRC Environmental Corp

SEE AD ON PAGE 32

Traverse Group, The



Tymco Inc
U S Environmental Engineering Inc



Unipure Environmental
Zimpro Environmental Inc

Strainers

Alfa Laval Thermal Inc
Badger Meter Inc
Dunrom Co Inc
Fiamatic Valves Corp
Kraissl Co Inc
Mars Co
Pego Systems Inc
Plasti-O-Matic Valves Inc
R P Adams Co Inc
Specialty Mfg Co, The
Spraying Systems Co

Sulfate/Sulfide Detectors

Air Instruments & Measurements Inc
American Safety & Abatement Products Inc
CEA Instruments Inc
International Sensor Technology
McNeill Intl
Myrad Industries
Olind Safety
RKI Instruments Inc
Scott Lawson Group Inc, The
Sierra Monitor Corp

Sulfur Dioxide

Advanced Pollution Instrumentation Inc
Air Instruments & Measurements Inc
Anarad Inc



Control Instruments Corp
Dasibi Environmental Corp
Detcon Inc
EIT
Energy Efficiency Systems Inc
Hazzo Services Inc
Intek Corp/Pent-Alyzer
Metrotronics Inc
Misonix Inc
Olind Safety
RKI Instruments Inc
SCI-TEC Instruments Inc
Scott Lawson Group Inc, The

Scott Specialty Gases
Sierra Monitor Corp
Valient Safety Supply Co

Sulfur Oxide Detectors

Advanced Pollution Instrumentation Inc
Air Instruments & Measurements Inc
American Environmental Instruments Inc
American Sity & Abatement Products Inc
Anarad Inc
Bacharach Inc
Biosystems Inc
CEA Instruments Inc
Clean Air Engineering
Disal Safety Equipment
Ecom America
Ermet Corp
Gas Tech Inc
Hazzo Services Inc
Horiba Instruments Inc
Industrial Scientific Corp
Intek Corp/Pent-Alyzer
International Sensor Technology
Interscan Corp
Lumidior Safety Products
McNeill Intl
Mil-Ram Technology Inc
Milo Safety Rental
Monitor Labs Inc
Myrad Industries
Olind Safety
RKI Instruments Inc
Rosemont Analytical Inc
Sensidyne Inc
Servomex Co Inc
Siemens Energy & Automation Inc
Spectra Gases Inc
Transducer Research Inc
U S Industrial Products Co Inc
Valient Safety Supply Co

Suspended Solids Instrumentation

BTG Div of Spectris Technologies Inc
Plastronics Inc
Plexico
Poly Processing Co
Pope Scientific Inc
RMJ Machinery Inc
Rain for Rent
Remediation Inc
Structural North America
SEE AD ON PAGE 22
Testwell Craig Laboratories Inc
Total Containment
Universal Process Equipment Inc

SEE AD ON PAGE 71



Fabrico Environmental Liners Inc
Fluid Containment Inc
Goat Co
Hazen & Sawyer
Highland Tank & Mfg Co
International Reserve Equipment Corp
Met-Pro Corp Systems Div
North American Environmental Corp
Osmonics Inc
SEE AD ON PAGE 25
Plastic Fusion Fabricators Inc
Plastronics Inc
Plexico
Poly Processing Co
Pope Scientific Inc
RMJ Machinery Inc
Rain for Rent
Remediation Inc
Structural North America
SEE AD ON PAGE 22
Testwell Craig Laboratories Inc
Total Containment
Universal Process Equipment Inc

Sweepers, Air Sweepers

Wester Inc

Sweepers, In Plant Sweepers

Wester Inc



Tymco Inc

Sweepers, In Plant Sweepers



Tymco Inc

Sweepers, Truck Mounted - In Plant

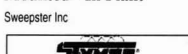

Tymco Inc

Tank Linings



Sentry Polymers Inc

Tanks

Aero Tec Laboratories Inc
SEE AD ON PAGE 45
Air Plastics Inc
Aero-Power Utilized Fueler Inc
A O Smith Harvester
SEE AD ON PAGE 29, 74
Assmann Corp of America
Atlas Minerals & Chemicals Inc
August Mack Environmental Inc
Baker Tanks Inc
Bergen Barrel & Drum Co
Blymyer Engineers Inc
Brown-Minneapolis Tank
Chem-Trainer Industries



Columbian Steel Tank Co
Convaunt Inc
Davis Process Div
Drums Inc
Dual Div Met-Pro Corp
Earth Remediation Services Inc
Enecon Services Inc
Enpac Corp
Environics Inc
Environmental Products & Services Inc
Environmental Tank Systems Inc (ETS)
Exploration Products
SEE AD ON PAGE 71

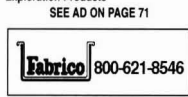

Fabrico Environmental Liners Inc
Fluid Containment Inc
Goat Co
Hazen & Sawyer
Highland Tank & Mfg Co
International Reserve Equipment Corp
Met-Pro Corp Systems Div
North American Environmental Corp
Osmonics Inc
SEE AD ON PAGE 25
Plastic Fusion Fabricators Inc
Plastronics Inc
Plexico
Poly Processing Co
Pope Scientific Inc
RMJ Machinery Inc
Rain for Rent
Remediation Inc
Structural North America
SEE AD ON PAGE 22
Testwell Craig Laboratories Inc
Total Containment
Universal Process Equipment Inc

TCLP

Aqua Tech Environmental
Laboratories Inc (ATEL)
Burns & McDonnell Waste
Consultants Inc
Camp Dresser & McKee Inc
Clean World Engineering Ltd
Eckenfelder Inc
Ensolect Inc
Environmental Laboratory Services
Environmental Products & Services Inc
Environmetrics
HES Inc
Heritage Environmental Services Inc
Midwest Laboratories Inc
Milipore Corp
North American Environmental Corp
Northern Lake Service Inc
Pittsburgh Activated Carbon Services Inc
Pattens Environmental Services
Ross Analytical Services Inc
SERC0 Laboratories
Scott Lawson Group Inc, The
Soil Solutions Inc
Williams Environmental Services Inc

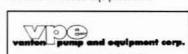

Vanton Pump & Equipment Corp

Telemetry Systems

Campbell Scientific Inc

Campbell Scientific Inc

Campbell Scientific Inc

Campbell Scientific Inc

Campbell Scientific Inc

Campbell Scientific Inc

Campbell Scientific Inc

Campbell Scientific Inc

Campbell Scientific Inc

Telescoping Valves

Climatronics Corp
SEE AD ON PAGE 110
Dancer Communications Inc
Environmental Restoration Systems
Environmental Systems Engineering Inc
GeoPure Systems & Services
Global Water
Hander
Novalex Corp
Pace Transducer Div of
CJ Instruments Inc
Phonetics Inc
R E Wright Environmental Inc
Remediation Service Intl
Schneider Instrument Co
Telog Instruments Inc
YSI Inc



Halliday Products Inc

Temperature Instrumentation

Advanced Data Systems
Automatic Switch Co (ASCO)
Bailey Controls Co
Brooklyn Thermometer Co Inc
Campbell Scientific Inc
Capital Controls Co Inc
Coastal Environmental Systems
Dwyer Instruments Inc
Epic Inc
Extach Instruments
Fluid Components Intl
Foxboro Co, The
GeoGuard Inc
Glas-Col
Hazzo Services Inc
HydroLab Corp
SEE AD ON PAGE 40, 118
Instrumentation Northwest Inc (INW)
Johnson Yokogawa Corp
Keithley Metrabyte
Logic Beach Inc

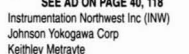

MMC International Corp
SEE AD ON PAGE 24
Met One Instruments Inc
SEE AD ON PAGE 43, 85

Metrotronics Inc
Monarch Instrument
Myrad Industries
Novalex Corp
Omega Engineering Inc
SEE AD ON PAGE 2

Onset Computer Corp
Pace Transducer Div of CJ Instruments
Inc
R M Young Co
Remtech Inc
Telatemp Corp
Testo Inc
SEE AD ON PAGE 72

Ultra-Research Inc
Weather Network Inc
YSI Inc

Ultra-Research Inc
Weather Network Inc
YSI Inc

Ultra-Research Inc
Weather Network Inc
YSI Inc

Ultra-Research Inc
Weather Network Inc
YSI Inc

Ultra-Research Inc
Weather Network Inc
YSI Inc

Ultra-Research Inc
Weather Network Inc
YSI Inc

Ultra-Research Inc
Weather Network Inc
YSI Inc

Ultra-Research Inc
Weather Network Inc
YSI Inc

Ultra-Research Inc
Weather Network Inc
YSI Inc

Ultra-Research Inc
Weather Network Inc
YSI Inc

Ultra-Research Inc
Weather Network Inc
YSI Inc

Ultra-Research Inc
Weather Network Inc
YSI Inc

Total Nitrogen Analyzers

Myron L Co
National Instruments
New Pig Corp
SEE AD ON PAGE 49, 99
Orbeco Analytical Systems Inc
Pace Transducer Div of
CJ Instruments Inc
SKS Bottle & Packing Inc
Sensidyne Inc
Spectronics Corp
Taylor Technologies Inc
Terra Universal Inc
Wonder Makers Inc
Zero Enclosures

Test Kits/Services

Art's Manufacturing & Supply
Ben Meadows Co
BioNebraska Inc
Bioscience Inc
CEA Instruments Inc
Chemetrics Inc
E M Science
ELB & Associates Inc
ESSO (Earth Systems & Solutions Corp)
Hach Co
Heritage Environmental Services Inc
Horiba Instruments Inc
Idetek Inc/Quantix Environmental
InVivo Intl
SEE AD ON PAGE 163



Mid-West Instrument
Milipore Div
Myrad Industries
Orbeco Analytical Systems Inc
Pace Inc
Polybac Corp
SKS Bottle & Packing Inc
Sensidyne Inc
Sunshine Technology Corp
Taylor Technologies Inc
Teledyne Brown Engineering -
Environmental Services
Wonder Makers Inc
YSI Inc

TOC Detectors

Anatel Corp
CEA Instruments Inc
Horiba Instruments Inc
Intek Corp/Pent-Alyzer
Ionics Inc
OI Analytical
Shimadzu Scientific Instruments Inc
Zellweger Analytical Inc

Tools

American Gas Products Inc
Mars Co
Pestek Corp
Stanley Hydraulic Tools
Structure Probe Inc/SPI Supplies
Wonder Makers Inc

Total Carbon Detectors

American Sity & Abatement Products Inc



Control Instruments Corp
Horiba Instruments Inc
Intek Corp/Pent-Alyzer
Ionics Inc
McNeill Intl
Myrad Industries
Valient Safety Supply Co
Zellweger Analytical Inc

Total Nitrogen Analyzers

American Sity & Abatement Products Inc
Horiba Instruments Inc
Intek Corp/Pent-Alyzer
McNeill Intl
Myrad Industries
Orbeco Analytical Systems Inc
Perkin-Elmer Corp

PRODUCTS/SERVICES

Total Nitrogen Analyzers

RKI Instruments Inc
Valien Safety Supply Co
Zellweger Analytics Inc

Total Oxygen Demand

Anatel Corp
Ionics Inc
Ionics Inc
Mazzei Injector Corp
Myriad Industries
Orbeco Analytical Systems Inc
Valien Safety Supply Co
Zellweger Analytics Inc

Total Sulfur Detectors

Advanced Pollution Instrumentation Inc
American Sity & Abatement Products Inc
Anarad Inc
Del Mar Scientific Inc
International Sensor Technology
McNeill Intl
Myriad Industries
Valien Safety Supply Co
Zellweger Analytics Inc

Toxic Gas Detectors

Air Instruments & Measurements Inc
American Environmental Instruments Inc
American Sity & Abatement Products Inc
Anarad Inc
AramSCO
Argus Environmental Monitoring
Arizona Instrument Corp
Assay Technology Inc
Bacharach Inc
Biosystems Inc
CEA Instruments Inc
Capital Controls Co Inc



Control Instruments Corp
Delcon Inc
Dival Safety Equipment
Diversified Well Products Inc
EIT
Enmet Corp
Environmental Products & Services Inc

FOXBORO
800-321-0322

Foxboro Co, The

GARCH
510-745-8700

Gas Tech Inc
Grace Industries Inc
Graseby

SEE AD ON PAGE 15, 89

HNU Systems Inc
Hazzo Services Inc
Horiba Instruments Inc
Industrial Scientific Corp
Intek Corp/Rent-Alyzer
International Sensor Technology
Lumidor Safety Products
McNeill Intl
Metrosonics Inc

MIL-RAM
Technology, Inc.
408-293-5085

Mil-Ram Technology Inc
Mico Safety Rental
Monitor Labs Inc
Oilind Safety
Photovac Monitoring Instruments
SEE AD ON PAGE 51, 57

RKI Instruments Inc
Rae Systems Inc
SCH-TEC Instruments Inc
Scott Lawson Group Inc, The
Scott Specialty Gases
Sensidyne Inc
Sensor Electronics Corp
Senvemox Co Inc

Sierra Monitor Corp
Spectra Gases Inc
Spectrex Corp
Stratford Research Inc
U S Industrial Products Co Inc
Ultra-Research Inc
Valien Safety Supply Co
Zellweger Analytics Inc

Toxicological Services

ABB Environmental Services Inc
Blasland Bouck & Lee Inc
Burns & McDonnell Waste
Consultants Inc
Chester Environmental
Dyncorp Environmental Energy & Natl
Security Programs
ERIM Group Inc
Environmental Products & Services Inc
ICF Kaiser International Inc
Industrial Testing Services/Environmental
Laboratories
Mabbett & Associates Inc
R E Wright Environmental Inc
Radcan Corp
Rollins Environmental Services
Roy F Weston Inc
Sverdrup Environmental Inc
TRC Environmental Corp
SEE AD ON PAGE 32
Terra Consulting Group Inc
Walk, Haydel & Associates Inc
Wellair Inc

Tracer Products

Crompton & Knowles Colors Inc
Instrumentation Northwest Inc (INW)

Training Environmental Science



Environmental Education Enterprises E3

Training Management Software

Achieve! Technology Inc
Chemical Safety Corp
Enercon Services Inc
Environmental Training Group Inc
Health Consultants Inc
J J Keller & Associates
NUS Training Corp
Sewall, James W

Training Personal Protective Equipment



FLI Learning Systems Inc

Training Services/ Equipment

AAA Environmental
AGA Gas Inc
Advanced Data Systems
Balfey Controls Co
Blymyer Engineers Inc
Bovar Environmental
Capsule Environmental Engineering Inc



Comco Inc
Con-Tess/ATC Environmental Inc
D G Supplies Inc
Danatec Educational Services Ltd
Delta Environmental Consultants Inc
Diversified Well Products Inc
ELB & Associates Inc3
Emilcott Associates
Emilcott-dga Inc

Energy Efficiency Systems Inc
Enviro-Assist Inc
Enviro Consultants Inc
Environmental Education Enterprises E3
Environmental Products & Services Inc
Environmental Safety Services
Environmental Science & Engineering Inc
Environmental Support Solutions
Environmental Training Group Inc
GTS Duratek
HMTRI Hazardous Material Handling &
Research Institute
Haztech Systems Inc
Health Consultants Inc
Heritage Environmental Services Inc
J J Keller & Associates
JT Baker Div of Mallinckrodt Baker Inc
John Crane Intl
Kemper Risk Management Services
Laidlaw Environmental Services
Mabbett & Associates Inc
Marine & Environmental Testing Inc
Mec One Instruments Inc
SEE AD ON PAGE 43, 85
NUCON Intl Inc
NUS Training Corp
National Technical Information Service
Nelson Enterprises
Network Environmental
Systems Inc (NES)
OGCI Training Inc
Occupational Health & Hygiene
Corp of America
Perkin-Elmer Corp
Pittsburgh Activated Carbon Services Inc
Primalech Inc
R E Wright Environmental Inc
Raytheon Environmental Svcs/
Raytheon Engineers & Construction
Right-To-Know Training Institute
Rocky Mtn Ctr for Occup & Enviro Health
SSOE Inc
STP Specialty Technical Publishers Inc

Northwest Environmental Services
Testing & Training



Safety-Kleen Corp
Scott Lawson Group Inc, The
Sunshine Technology Corp
TRC Environmental Corp
SEE AD ON PAGE 32

Testwell Craig Laboratories Inc
3M Occupational Health &
Environmental Safety Div
Transport Law Research Inc
Trinity Consultants Inc
Univ of California Extension Ctr for
Media & Independent
University of Findlay, The



Waid & Associates
Wonder Makers Inc

Training Videos

AGA Gas Inc
Aurora Pictures Inc
BNA Communications Inc
Balfey Controls Co
Blymyer Engineers Inc
Danatec Educational Services Ltd
ERIM Group Inc
Emergency Film Group
Emilcott Associates
Emilcott-dga Inc
Enmet Corp
Environmental Resource Center
Health Consultants Inc
J J Keller & Associates
JT Baker Div of Mallinckrodt Baker Inc
NUS Training Corp
National Technical Information Service
New Pig Corp
SEE AD ON PAGE 49, 99

R E Wright Environmental Inc
Safety-Kleen Corp
Scott Lawson Group Inc, The
Southern Methodist University
Spectronics Corp
3M Occupational Health &
Environmental Safety Div
Valien Safety Supply Co

Transmitters

Acomrag Inc
Advanced Data Systems
Badger Meter Inc
Baley Controls Co
Dwyer Instruments Inc
Fluid Components Intl
Foxboro Co, The
Hawk America Inc
Instrumentation Northwest Inc (INW)
Johnson Yokogawa Corp
K P S I
Miltronics Inc
Monitek Technologies Inc
Omega Engineering Inc
SEE AD ON PAGE 2
Pace Transducer Div of CJ Instruments Inc
Vaisala Inc

Transport in Porous Media



Northwest Environmental Services
Testing & Training

Transportation

Ashland Chemical Co
SEE AD ON PAGE 7
Blymyer Engineers Inc
Clean Harbors Environmental Srv Inc
Cushman
Environmental Products & Services Inc
Environmental Science & Engineering Inc
Heritage Environmental Services Inc
North American Environmental Corp
Soil Solutions Inc
Transport Law Research Inc

Traps

Restek Corp

Trenchless Pipeline Rehabilitation



Insituform Technologies Inc

Trucks/Trailers

Advanced Containment Systems Inc
Ameri-can Engineering
Art's Manufacturing & Supply



Clements Industries

Cushman
Environmental Systems Engineering Inc
Hazzo Services Inc
Hertz Equipment Rental Corp
Kann Manufacturing Inc
Soil Solutions Inc
Turbidity Instrumentation
American Environmental Instruments Inc
Ametek Process & Analytical
Instruments Div
BTG Div of Spectris Technologies Inc
Capital Controls Co Inc
Coastal Environmental Systems
Coastal Leasing Inc
Diversified Well Products Inc
Geotech Environmental Equipment Inc
Global Water
Great Lakes Instruments
Hach Co
Hazzo Services Inc
Horiba Instruments Inc
Hyde Products
HydroLab Corp
SEE AD ON PAGE 40, 118

Turbidity Instrumentation

Instrumark International Inc
Intek Corp/Rent-Alyzer

Underground Tank Leak Monitors

Mettler-Toledo Process Analytical Inc
Monitek Technologies Inc
Myriad Industries
Novolyx Corp
Omega Engineering Inc
SEE AD ON PAGE 2
Orbeco Analytical Systems Inc
Osmonics Inc
SEE AD ON PAGE 25
Rosemont Analytical Inc
Royce Instrument Corp
Schneider Instrument Co
Solomat - Neutronics
Wilkins-Anderson Co
YSI Inc

Turbidity Standards

Hach Co
Hazzo Services Inc
Monitek Technologies Inc
Myriad Industries
Orbeco Analytical Systems Inc
Solomat - Neutronics

Ultrafiltration Equipment

AAF Intl
APV Anhydro-Separation Technologies
Alfa Laval Sharples, Alfa Laval Separators
Allied Signal Inc Filtration Systems
Applied Membranes Inc
Baler Equipment Co



Desalination Systems Inc
Filterspun
Hyde Products
Ionics Inc
Kinetic Inc Engineered Systems Div
Millipore Corp
Osmonics Inc
SEE AD ON PAGE 25

Ozact Inc
Prosys Corp
RGF Environmental Systems Inc
Samsco Inc
SEE AD ON PAGE 101

Sanborn Technologies
Serfilco Lts
Smith & Loveless Inc
Treatment Technologies
U S Environmental Engineering Inc
United States Filter Corp
Universal Process Equipment Inc
Water Equipment Technologies Inc
Western Filter Co

Underground Storage Tank Equipment

Alton Geoscience Inc
Atlantic Screen & Mfg
Brown-Minneapolis Tank
CEA Instruments Inc
Camber Corp
Conti Environmental Inc
Davis Process Div
EBW Inc
Environmental Products & Services Inc
Euro Tank & Ecosafe Systems Inc
Plastic Fusion Fabricators Inc
R E Wright Environmental Inc
Tapecoat Company, The
Total Containment
Veeder-Root Co

Underground Tank Leak Monitors

Alton Geoscience Inc
AramSCO
Arizona Instrument Corp



Art's Manufacturing & Supply
CEA Instruments Inc
EBW Inc
Enercon Services Inc
Enmet Corp
Environmental Products & Services Inc
Euro Tank & Ecosafe Systems Inc
FCI Environmental Inc

Underground Tank Leak Monitors

FOXBORO
800-321-0322

Foxboro Co. The
Gas Tech Inc
Gem Sensors Div
Hazo Services Inc
Health Consultants Inc
Highland Tank & Mfg Co
Photovac Monitoring Instruments
SEE AD ON PAGE 51, 57

Plastic Fusion Fabricators Inc
R E Wright Environmental Inc
Rae Systems Inc
Sensidyne Inc

Tracer Research Corporation
800-394-9929

Tracer Research Corp
SEE AD ON PAGE 41
U S Industrial Products Co Inc
Veeder-Root Co

Vacuum Cleaning Equipment

American Sity & Abatement Products Inc
AramSCO
Baker Tanks Inc
DeMarco MAX VAC Corp
Drip Free Packing Co

EG & G ROTRON
914-246-3401

EG & G Rotron - Industrial Products Div
Environmental Products & Services Inc
Goodway Technologies Corp
Lamson Corp
Nilfisk of America Inc
Pego Systems Inc
Spencer Turbine Co, The

VAC-U-MAX
800-289-8228

Vac-U-Max
Valien Safety Supply Co

Vacuum Loading Equipment

DeMarco MAX VAC Corp
Pego Systems Inc
Soil Solutions Inc
Sweepster Inc

VAC-U-MAX
800-289-8228

Vac-U-Max

Vacuum, Critical Filter

AramSCO
DeMarco MAX VAC Corp
Goodway Technologies Corp
Nilfisk of America Inc

Valve Actuators/Operators

Asahi/America Inc
Chemtrol Div of Nibco Inc
Durrion Co Inc
Dwyer Instruments Inc
Foxboro Co. The
George Fischer Inc
Invalco Inc
Jerman, Daniel L. Co
Justrite Manufacturing Co LLC
Raisi Co Inc
Larox Inc

NIBCO
800-642-5463

Nibco Inc
Omega Engineering Inc
SEE AD ON PAGE 2
Parker Hannifin Corp
Plast-O-Matic Valves Inc

Progressive Equipment Corp
Rosemount Analytical Inc
Swagelok Companies, The

Valve Positioners

Custom Switches
Durrion Co Inc
Dwyer Instruments Inc
Foxboro Co. The
George Fischer Inc
Larox Inc
Parker Hannifin Corp
Rosemount Analytical Inc

Valve Replacement Parts

Automatic Switch Co (ASCO)
CLA-VAL Co
Chemtrol Div of Nibco Inc
Durrion Co Inc
Flomatic Valves Corp
Goyen Valve Corp
Larox Inc

Valve Systems

Automatic Switch Co (ASCO)
Berman Inc
CLA-VAL Co
Durrion Co Inc
Dwyer Instruments Inc
Foxboro Co, The
George Fischer Inc
Larox Inc
MKS Instruments Inc
Mars Co
Parker Hannifin Corp
Perkin-Elmer Corp
Plast-O-Matic Valves Inc
R E Wright Environmental Inc
Swagelok Companies, The

VICI
800-367-8424

VICI Valco Instruments Co Inc

Valves

A & J Management Resources Inc
Applied Membranes Inc
Asahi/America Inc
Automatic Switch Co (ASCO)
Berman Inc
Brooks Instrument
CLA-VAL Co
Chemtrol Div of Nibco Inc

CGS
516-467-1600

Clean Gas Systems Inc
Dow Plastic-Lined Piping Products
Durrion Co Inc
Dwyer Instruments Inc
EBW Inc
Eclipse Combustion Inc
Flomatic Valves Corp
Foxboro Co. The

flexible valve corporation
800/233-6294

Flexible Valve Corp
George Fischer Inc
Goyen Valve Corp
Griswold Controls
Hersey Products
Invalco Inc
Jerman, Daniel L. Co
Justrite Manufacturing Co LLC
Raisi Co Inc
Larox Inc
M L E
MKS Instruments Inc

M.M.C.
800-645-7339

M.M.C. International Corp
SEE AD ON PAGE 24
Mars Co

Mid-West Instrument
800-648-5778

Mid-West Instrument
Moyno Industrial Products Unit of
Omega Engineering Inc
SEE AD ON PAGE 2
Robbins & Myers Inc

NIBCO
800-642-5463

Nibco Inc
OPW Fueling Components
Osmonics Inc
SEE AD ON PAGE 25

PBM Inc
Parker Hannifin Corp
Plast-O-Matic Valves Inc
Plastic Fusion Fabricators Inc
Progressive Equipment Corp
Scott Specialty Gases
Specialty Mfg Co, The
Spectra Gases Inc
Spencer Turbine Co, The
Spraying Systems Co
Swagelok Companies, The
Tylan General Inc

VICI
800-367-8424

VICI Valco Instruments Co Inc

vici
vibration pump and equipment corp.
908-688-4216

Vanton Pump & Equipment Corp
Warman Intl Inc

Vapor Recovery

ABB Environmental Services Inc
AGA Gas Inc
Alton Geoscience Inc
Anguil Environmental Systems Inc
Atlantic Fluidics Inc
Atlantic Screen & Mfg
August Mack Environmental Inc
Barneby & Sutcliffe Corp
Blymyer Engineers Inc
Civacon

DÜRR
313-459-6800

Durr Environmental Systems
EBW Inc
Edwards Engineering Corp
Environmental Restoration Systems
Environmental Systems Engineering Inc
GeoPure Systems & Services
GeoTrans Inc
Haley & Aldrich Inc
Horizontal Technologies Inc
Integrated Environmental Solutions Inc
SEE AD ON PAGE 35, 87
John Zink Co Div Koch Engineering Co
M-D Pneumatics Div Tuttil Corp
Membrane Technology & Research Inc

Morehouse-Cowles, Inc.
714-738-5000

Morehouse-Cowles Inc
NUCON Intl Inc
OPW Fueling Components
ORS Environmental Systems
Pego Systems Inc
QED Environmental Systems Inc
R E Wright Environmental Inc
Remedial Systems Inc
Servomex Co Inc

SUMMIT
800-344-0321

Summit Analyzers
Thermotron
Total Containment
Universal Process Equipment Inc
Xchanger Inc

Variable Speed Drives

Arvic Controls

Ventilation Equipment

American Sity & Abatement Products Inc
AramSCO
Argus Environmental Monitoring
August Mack Environmental Inc
Dival Safety Equipment
Dual Div Met-Pro Corp
Durr Environmental Systems
General Equipment Co
Hartzell Fan Inc
Hazo Services Inc
JBI Spray Booths & Finishing Systems
Misonix Inc
NUCON Intl Inc
New York Blower Co
Oilind Safety
Pego Systems Inc
Stanley Hydraulic Tools
United McGill Corp

Vents

Atlantic Screen & Mfg
August Mack Environmental Inc
EBW Inc
Justrite Manufacturing
Justrite Manufacturing Co LLC
L & L Process Industries Inc

Vibration Instruments

Campbell Scientific Inc
Coastal Environmental Systems
Dancer Communications Inc
Epic Inc
Monarch Instrument
Pace Transducer Div of
CJ Instruments Inc
Terra Universal Inc

Viscosity Instruments

Brinkmann Instruments Inc
Coastal Environmental Systems
Extex Instruments
Myriad Industries
Norcoros Corp
Wilkins-Anderson Co

VOC Removal Systems

ABB Air Preheater Inc
SEE AD ON PAGE 81
ABB Air Preheater Inc Raymond Prods
APV Anhydro-Separation Technologies
Adwest Technologies Inc
Airex Corp
American Gas Products Inc
Anguil Environmental Systems Inc
Atlantic Fluidics Inc
August Mack Environmental Inc
Barneby & Sutcliffe Corp
Blymyer Engineers Inc
CVT America LLC
Calgon Carbon Corp
Cameron Environmental Inc
Carbonair Environmental Systems Inc
Carbrotol Corp
College Research Corp (CORECO)
Croll Reynolds Co Inc
Dedert Corp
Delta Cooling Towers Inc
Ducon Environmental Systems Inc

DÜRR
313-459-6800

Durr Environmental Systems
ECO Purification Systems USA Inc
Edwards Engineering Corp

ENGELHARD
908-205-6618

Engelhard Corp
Environmental Recovery Resources Inc
Environmental Restoration Systems
Environmental Systems Engineering Inc
EnviroTrol Inc
GeoPure Systems & Services
GeoTrans Inc

Waste Minimization

Global Technologies
Goal Line Environmental Technologies
Grace Tec Systems
Hydro Group Inc

Integrated Environmental Solutions Inc

SEE AD ON PAGE 35, 87
JBI Spray Booths & Finishing Systems
Jaeger Products Inc
John Zink Co Div Koch Engineering Co
Johnson Matthey
Mazzei Injector Corp
Membrane Technology & Research Inc
Met-Pro Corp Systems Div
Misonix Inc

Monsanto Enviro-Chem Systems Inc.
314-275-5700

Monsanto Enviro-Chem Systems Inc
NUCON Intl Inc
North East Environmental Products Inc
Northwestern Carbon
ORS Environmental Systems
Omega Engineering Inc
SEE AD ON PAGE 2
Paragon Environmental Systems Inc

PRAXAIR
800-772-9247

Praxair Inc
Prototech Co, The
QED Environmental Systems Inc
R E Wright Environmental Inc
Remedial Systems Inc
Remediation Service Intl
Therm Tech Inc
Thermotron
U S Environmental Engineering Inc
Unpure Environmental

Unisorb Corp.
713-943-3753

Unisorb Corp
United McGill Corp
United States Filter Corp
Universal Process Equipment Inc

VAC-U-MAX
800-289-8228

Vac-U-Max

VARA
INTERNATIONAL
407-567-1320

Vara Intl Div of Calgon Carbon Corp
Weatherly Inc
Wheelabrator Clean Air Systems Inc
Wheelabrator Technologies Inc
Williams Environmental Services Inc
Winsor & Jerauld

Wolverine
414-336-5231

Wolverine (Massachusetts) Corp
Xchanger Inc

Waste Minimization

Allied Environmental Consultants Inc
Alta Resource Mgmt Services Inc
Alton Geoscience Inc
August Mack Environmental Inc
BFI (Browning Ferris Industries Inc)
Barneby & Sutcliffe Corp
Blastland Bouck & Lee Inc
Bovar Environmental
Brown & Caldwell
Burns & McDonnell Waste
Consultants Inc
CDM Federal Programs Corp

CDM Camp Dresser & McKee Inc.
617-621-8181

Camp Dresser & McKee Inc
Capsule Environmental Engineering Inc
Cartwright Consulting Co
Century West Environmental Inc

PRODUCTS/SERVICES

Waste Minimization

Chemical Safety Corp
Chester Environmental
ChromatoChem Inc
Clean Harbors Environmental Srv Inc
Clean World Engineering Ltd
College Research Corp (CORECO)
Compacting Technologies

DAMES & MOORE
213-683-0471

Dames & Moore
Delta Environmental Consultants Inc
ELB & Associates Inc
EMC Equipment Manufacturing Corp
ENSR
ERM Group Inc
ESSC (Earth Systems & Solutions Corp)
Ensolech Inc
Environmental Compliance Products
Environmental Education Enterprises E3
Environmental Recovery Resources Inc
Environmental Resource Center
Environmental Science & Engineering Inc
Environmental Technical Services Inc
Environmental Waste Technology Inc
Export Technologies Inc
Foth & Van Dyke
Geraghty & Miller Inc a Heidmij Co
Harding Lawson Associates
SEE AD ON PAGE 34

Hazclean Environmental Consultants Inc
Heritage Environmental Services Inc
High Plains Consortium Inc
Hycor Corp
Hyde Products
JWI
Jordan Systems
Joseph Marketing Inc
K-F Environmental Technologies Inc
Katec Inc
Kilam Associates
Kinetic Inc Engineered Systems Div
Landa Water Cleaning Systems
Mabbett & Associates Inc
Metcalf & Eddy
Millennium Science & Engineering Inc
National Technical Information Service
Network Environmental Systems Inc
(NES)
Netsch Inc
North American Environmental Corp
Pacific Environmental Services Inc
SEE AD ON PAGE 56, 88

Pollution Research & Technology Inc (PRT)

PORTEC
605-665-8770

Portec C E D Environmental Products
Probiotic Solutions
R E Wright Environmental Inc
RMT Inc
Raytheon Environmental Svcs/
Raytheon Engineers & Construction
Resources Conservation Co
Right-To-Know Training Institute
Roy F Weston Inc
SRS Industrial Engineering Inc
SSOE Inc
Safety-Kleen Corp
Samsco Inc
SEE AD ON PAGE 101

Sanborn Technologies
Saturn Shredders Div of MAC Corp
Serio-Us Lock
Shields Environmental Corp
Shred-Tech
Soil Solutions Inc
Strong Environmental Inc
Sverdrup Civic Inc
Sverdrup Environmental Inc
TNT Technology Co
Traverse Group, The
Universal Process Equipment Inc
Vanco Engineering Group
W Canning Inc
Wheelabrator Water
Technologies Inc Bio Gro Div

Wastewater Treatment Systems

ABB Environmental Services Inc
AFL Industries Inc

APV Anhydro-Separation Technologies
Aeration Industries Intl Inc
Aeromix Systems Inc
Alfa Laval Sharples,
Alfa Laval Separation Inc
Allied Environmental Consultants Inc
Alton Geoscience Inc
American Technologies Group Inc
Andco Environmental Processes Inc
August Mack Environmental Inc
BioGro Div Wheelabrator Clean
Water Systems Inc
BioTrol Inc
Bioscience Inc
Bird Machine Co Inc
Bovar Environmental
Brown & Caldwell
Brown-Minneapolis Tank
Burns & McDonnell Waste
Consultants Inc
CDM Federal Programs Corp
CEA Instruments Inc
CINC
SEE AD ON PAGE 25

CNA Insurance
SEE AD ON PAGE 4, 107
Calgon Carbon Corp
Cameron-Yakima Inc

CDM Camp Dresser & McKee Inc.
617-621-8181

Camp Dresser & McKee Inc
Capital Controls Co Inc
Carbon Activated
Carbtrol Corp
Celite Corp
Century West Environmental Inc
Chemical Lime Co
Chester Environmental
Chief Industries Inc
ChromatoChem Inc
Clean Harbors Environmental Services Inc
College Research Corp (CORECO)
Colloid Environmental Technologies Co
Controltron
Cytex Industries Inc
DEL Industries
Dames & Moore
Davco Div Davis Water & Waste
Industries Inc
Deep Shaft Technology Inc
Delta Cooling Towers Inc

DESAL
DESALINATION SYSTEMS, INC.
619-598-3334

Desalination Systems Inc

DIAGENEX INC.
Waste Water Systems For A Better Way
510-606-5600

Diagenex Inc
Duriron Co Inc

DÜRR
313-459-6800

Durr Environmental Systems
ECO Purification Systems USA Inc
EIMCO Process Equipment
EMC Equipment Manufacturing Corp
ERIM Group Inc
Envirex Inc
EnviroQuip International Inc
Environmental Products & Services Inc
Environmental Recovery Resources Inc
Environmental Science & Engineering Inc
Environmental Tank Systems Inc (ETS)
Environmental Technical Services Inc
Envirotrol Inc
Export Technologies Inc
Flo Trend Systems Inc
SEE AD ON PAGE 64, 91

Foth & Van Dyke
Framco Environmental Technologies
Frontier Technology Inc
General Carbon Corp
Genisys Inc
GeoTrans Inc
Geraghty & Miller Inc a Heidmij Co
Graef, Anhalt, Schloemer & Associates Inc
Great Lakes Environmental Inc
Hach Co

Hankin Environmental Systems, Inc.™
908-722-9595

Hankin Environmental Systems Inc
Harbortec Corp
Harding Lawson Associates
SEE AD ON PAGE 34

Hazclean Environmental Consultants Inc
Hazen & Sawyer
Heritage Environmental Services Inc
Horsehead Resource Development Co Inc
Hudson Industries
Hycor Corp
Hyde Products

HydroCal
800-877-0765

HydroCal
Industrial Filter & Pump Mfg Co
Innovative Concepts Program
Intec Controls
International Reserve Equipment Corp
Ionics Inc
JWI
Kilam Associates
Kinetic Inc Engineered Systems Div
Landa Water Cleaning Systems
Larx Inc
Mabbett & Associates Inc

Martin Marietta Magnesia Specialties
800-648-7400

Martin Marietta Magnesia Specialties Inc
Maxymilian Technologies Inc
Mazzei Injector Corp
Met-Pro Corp Systems Div
Metcalf & Eddy
Mid-Western Processes Inc
Millennium Science & Engineering Inc
Morrison Knudsen Corp
National Technical Information Service
Netsch Inc

NIRO
410-997-8700

Niro Inc
Northwest Environmental Services
Testing & Training
Northwestern Carbon
Oil Skimmers Inc
On-Site * Otsite Inc
Osmonics Inc
SEE AD ON PAGE 25

Pego Systems Inc
Polybac Corp
ProBios Inc
Progressive Equipment Corp
Prosys Corp
Puresream Inc
R E Wright Environmental Inc
RGF Environmental Systems Inc
RMT Inc
Raytheon Environmental Svcs/
Raytheon Engineers & Construction
Resources Conservation Co
Rosemount Analytical Inc
Samsco Inc
SEE AD ON PAGE 101

Seghers Dinamec Inc
Serengeti Environmental
Sevenson Environmental Services, Inc.
716-284-0431

Sevenson Environmental Services Inc
Sharp & Associates Inc
Smith & Loveless Inc
Solvent Recovery Systems Inc
Somat Corp
Spencer Turbine Co, The
Star Systems Filtration Div/
Hilliard of South Carolina
Stoekhausen Inc
Suburbia Systems Corp
Sverdrup Civic Inc
Sverdrup Environmental Inc
TNT Technology Co
Tenco Hydro Inc
Therm Tech Inc
3M Filtration Products

Traverse Group, The
Treatment Technologies
U S Environmental Engineering Inc
United States Filter Corp
Universal Process Equipment Inc
Vanco Engineering Group
Vibra Screw Inc
Vulcan Peroxidation Systems Inc
Waste-Tech Inc
Wheelabrator Clean Air Systems Inc
Wheelabrator Clean Water Inc - HPD Div
Wheelabrator Clean Water Inc - Memtek Div
Wheelabrator Technologies Inc
Wheelabrator Water
Technologies Inc Bio Gro Div
Williams Environmental Services Inc
Wyo-Ben Inc
Zimpro Environmental Inc

Water Conditioning Equipment

Applied Membranes Inc
Capital Controls Co Inc
Chemmer Inc
Culligan Intl
Delta Cooling Towers Inc
Filterspun
Hydro Group Inc
Industrial Filter & Pump Mfg Co
Osmonics Inc
SEE AD ON PAGE 25

Radon Detection Systems Inc
Serfilco Lts
Treatment Technologies
U S Environmental Engineering Inc
Water Equipment Technologies Inc
Western Filter Co

Water Jetting Equipment

Atlantic Screen & Mfg
Framco Environmental Technologies
Goodway Technologies Corp
SRS Industrial Engineering Inc
Spraying Systems Co

Water Meters

ABB Kent Meters Inc
Advanced Data Systems
Badger Meler Inc
Berman Inc
Handar
Hazzo Services Inc
Hersey Products
Horiba Instruments Inc
ISTA Energy Systems Corp
Instruments Direct Inc
Intek Corp/Rent-Alyzer
Jerman, Daniel L. Co
Mars Co
Osmonics Inc
SEE AD ON PAGE 25

Progressive Equipment Corp
R E Wright Environmental Inc
SeaMetrics Inc
Sparing Instruments Co Inc
Water Specialties Corp

Water Purification Systems

Alfa Laval Sharples,
Alfa Laval Separation Inc
American Technologies Group Inc
Applied Membranes Inc
Aqua-Chem Inc
Burns & McDonnell Waste
Consultants Inc
Calgon Carbon Corp
Cameron-Yakima Co Inc
Carbon Activated
Carbtrol Corp
Celite Corp
Chester Environmental
ChromatoChem Inc
CNA Insurance
SEE AD ON PAGE 4, 107
Culligan Intl
DEL Industries

DESAL
DESALINATION SYSTEMS, INC.
619-598-3334

Desalination Systems Inc

Water Quality Instrumentation

Durr Environmental Systems
ECO Purification Systems USA Inc
Electrosynthesis Co Inc
Export Technologies Inc
Filterspun
General Carbon Corp
Harbortec Corp
Hungerford & Terry Inc
Industrial Filter & Pump Mfg Co
Intec Controls
Ionics Inc
Kinetic Inc Engineered Systems Div
Mazzei Injector Corp
Millipore Corp
Osmonics Inc
SEE AD ON PAGE 25

Ozacl Inc
Ozonology Inc
Progressive Equipment Corp
RGF Environmental Systems Inc
Radon Detection Systems Inc
Seghers Dinamec Inc
Serfilco Lts
Sverdrup Civic Inc
Sverdrup Environmental Inc
U S Environmental Engineering Inc
United States Filter Corp
Water Equipment Technologies Inc
Western Filter Co
Wheelabrator Technologies Inc
Worldwide Technology Inc

Water Quality Instrumentation

Agar Corp Inc
Applied Membranes Inc
Art's Manufacturing & Supply
BTG Div of Spectris Technologies Inc

BVS 610-273-2841

BVS Inc
Bio-Tek Instruments
CDS Analytical Inc
Campbell Scientific Inc
Capital Controls Co Inc
Chemetrics Inc
Chester Environmental
Coastal Environmental Systems
Dames & Moore
E S Industries
EIT
G O Environmental Inc
Global Water
Hazzo Services Inc
Horiba Instruments Inc
HydroLab Corp
SEE AD ON PAGE 40, 118

In-Situ Inc.
The Solutions People
800-446-7488

In-Situ Inc

SEE AD ON PAGE 31
Instrumentation Northwest Inc (INW)
Intek Corp/Rent-Alyzer
Ionics Inc
Isoo Inc Environmental Div
Johnson Yokogawa Corp
Kekc Instruments Inc
Logic Beach Inc
Manning Environmental Inc
McNeill Intl
Monarch Instrument
Montek Technologies Inc

MOUNT SOPRIS
Instrument Company,
INC.
303-279-3211

Mount Sopris Instrument Co
Myriad Industries
Myron L Co
Novalytic Corp
OI Analytical
ORS Environmental Systems
Orbeco Analytical Systems Inc
Perkin-Elmer Corp
QED Environmental Systems Inc
Rosemount Analytical Inc
Royce Instrument Corp
SRI Instruments
Schneider Instrument Co
Solomat - Neotronics

Spectrogram Corp
Taylor Technologies Inc
Tekmar Co
Testo Inc

SEE AD ON PAGE 72



TURNER DESIGNS
645 W. MAUDE AVENUE • SHERBOURNE, GA 30286
408-749-0994

Turner Designs Inc
SEE AD ON PAGE 21, 83
YSI Inc
Zelwegger Analytics Inc

Water/Wastewater Testing Chemicals



412-826-5230
LabChem Inc

Water/Wastewater Treatment Equipment

A C Schultes of NJ, MD, & DE
AAF Intl
AFL Industries Inc
Acron Inc
Aeration Industries Intl Inc
Aeromix Systems Inc
AirSep Corp
Alfa Laval Sharpies,
Alfa Laval Separation Inc
Allied Environmental Consultants Inc
American Lewa Inc
American Technologies Group Inc
Applied Membranes Inc
Baker Tanks Inc
Baler Equipment Co
BioTrol Inc
Bioscience Inc
Bird Machine Co Inc
Blue-White Industries
CEA Instruments Inc
CINC

SEE AD ON PAGE 25

CSF Treatment Systems Inc
Caigon Carbon Corp
Cameron Environmental Inc
Cameron-Yakima Inc
Capital Controls Co Inc
Carbon Activated
Carbolox Corp
Celite Corp
Chemetrics Inc
Chemical Lime Co
Chemineer Inc
Chief Industries Inc
Chlorinator Inc
ChromatoChem Inc
College Research Corp (CORECO)
Colloid Environmental Technologies Co



COLUMBIAN STEEL TANK COMPANY
913-621-3700

Columbian Steel Tank Co
Controltron
Culligan Intl
DEL Industries
Davco Div Davis Water & Waste Industries Inc
Davis Process Div
Delta Cooling Towers Inc



DESAL
DESALINATION SYSTEMS INC
619-598-3334

Desalination Systems Inc



DIAGENEX INC
Waste Water Systems For A Better Way
510-606-5600

Diagenex Inc
Ducon Environmental Systems Inc
Durrion Co Inc
Durr Environmental Systems
EIMCO Process Equipment
EMC Equipment Manufacturing Corp
EPG Companies
Edson Intl

Electrosynthesis Co Inc
Envirex Inc
Environmental Recovery Resources Inc
Environmental Systems Engineering Inc
Environmental Tank Systems Inc (ETS)
Export Technologies Inc
FMI Fluid Metering Inc
Fabrico Environmental Liners Inc
Filterspun
Flo Trend Systems Inc
SEE AD ON PAGE 64, 91
Framco Environmental Technologies
Frontier Technology Inc
General Carbon Corp
George Fischer Inc



GR PUMPS
419-755-1011

Gorman-Rupp Co, The
SEE AD ON PAGE 3

Great Lakes Environmental Inc
Great Lakes Instruments
Hach Co
Halliday Products Inc



Haskin Environmental Systems, Inc.
908-722-9595

Hankin Environmental Systems Inc
Harborlite Corp
Haz-Mat Containment Corp
Hudson Industries
Hungerford & Terry Inc
Hycor Corp
Hyde Products



HydroCal
800-877-0765

HydroCal
Industrial Filter & Pump Mfg Co
International Reserve Equipment Corp
Ionics Inc
Iso Inc Environmental Div
JWC Environmental
JWI
Jaeger Products Inc
Kinetic Inc Engineered Systems Div
Lakeside Equipment Corp
Lamson Corp
Landa Water Cleaning Systems
Larox Inc
Lundahl Instruments Inc
M L E
Manning Environmental Inc
Mars Co



Martin Marietta Magnesia Specialties
800-648-7400

Martin Marietta Magnesia Specialties Inc
Mazzei Injector Corp
Megator Corp
Met-Pro Corp Systems Div
Metcalf & Eddy
Microphor Inc
Monarch Separators Inc
National Technical Information Service

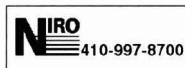

NIRO
410-997-8700

Niro Inc
Oil Skimmers Inc
OnSite * Orlite Inc
Osmonics Inc
SEE AD ON PAGE 25



PRAXAIR
800-772-9247

Ozonology Inc
Plast-O-Matic Valves Inc
Plastic Fusion Fabricators Inc
Plastronics Inc
Power Plant Services

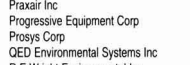

PRAXAIR
800-772-9247

Praxair Inc
Progressive Equipment Corp
Prosys Corp
QED Environmental Systems Inc
R E Wright Environmental Inc
RGF Environmental Systems Inc
RMT Inc
Rabko Environmental Liners Inc
Remedial Systems Inc
Resources Conservation Co
Rosemount Analytical Inc
Rotex Inc
SRS Cripsulfur Inc
Safety-Kleen Corp
Samsco Inc
SEE AD ON PAGE 101
Seghers Dinamec Inc
Serflico Lts
Sethco Div Met-Pro Corp



Senvon Environmental Services, Inc.
716-284-0431

Senvon Environmental Services Inc
Smith & Loveless Inc
Spectronics Corp
Spencer Turbine Co, The
Stokes Vacuum Inc
Suburbia Systems Corp
Syntech Inc
TNT Technology Co
Tartby of Delaware Inc
Therm Tech Inc
Treatment Technologies
U S Environmental Engineering Inc
Unipure Environmental
United States Filter Corp
Universal Process Equipment Inc
Vulcan Peroxidation Systems Inc
Walker Process Equipment
Div of McNish Corp
Water Equipment Technologies Inc
Wheelabrator Clean Air Systems Inc
Wheelabrator Clean Water Inc - HPD Div
Wheelabrator Clean Water Inc - Memtek Div
Zimpro Environmental Inc

Water/Wastewater Treatment Plants

A C Schultes of NJ, MD, & DE
APV Anhydro-Separation Technologies
Abanaki Corp Oil Skimmer Div
Aeration Industries Intl Inc
American Lewa Inc
Applied Membranes Inc

Aqua-Chem Inc
Bioscience Inc
Bovar Environmental
Burns & McDonnell Waste Con. Inc
CDM Federal Programs Corp
Chester Environmental
Chief Industries Inc
ChromatoChem Inc
Davco Div Davis Water & Waste Industries Inc
Deep Shaft Technology Inc
Durrion Co Inc
ECO Purification Systems USA Inc
Export Technologies Inc
Foth & Van Dyke
Graef, Anhalt, Schloemer & Assoc. Inc
Hazen & Sawyer
Heritage Environmental Services Inc
Hungerford & Terry Inc
Ionics Inc
Kilam Associates
Met-Pro Corp Systems Div
Metcalf & Eddy
Millennium Science & Engineering Inc
National Technical Information Service
Noell Inc
PSG
RMT Inc
Raytheon Environmental Svcs/
Raytheon Engineers & Construction
Remediation Inc
Resources Conservation Co
Safety-Kleen Corp
Sauereisen
Seghers Dinamec Inc



PRAXAIR
800-772-9247

Sevenson Environmental Services Inc
Smith & Loveless Inc
Soil Solutions Inc



Sevenson Environmental Services, Inc.
716-284-0431

Sevenson Environmental Services Inc
Smith & Loveless Inc
Soil Solutions Inc



SSC SUBURBIA SYSTEMS CORPORATION
800-223-2882

Suburbia Systems Corp
Sverdrup Civic Inc
Sverdrup Environmental Inc
TNT Technology Co
Treatment Technologies
U S Environmental Engineering Inc
United States Filter Corp
Western Filter Co
Wheelabrator Technologies Inc

Weather Monitoring

Adrian Brown Consultants Inc
Advanced Control Systems Corp



AIR SCIENCE CONSULTANTS, INC.
800-759-9282

Air Science Consultants Inc
Applied Technologies Inc
Ben Meadows Co
Campbell Scientific Inc
Coastal Environmental Systems
Dancer Communications Inc
Davis Instruments
Dwyer Instruments Inc
Environmental Systems Corp

Global Water
Handar
Hazzo Services Inc
Intec Controls
Novalyne Corp
Omega Engineering Inc
SEE AD ON PAGE 2
RM Young Co
SEE AD ON PAGE 67, 114



800-788-5666

Scientific Sales Inc
Scott Lawson Group Inc, The
Unidata America
Vaisala Inc
Weather Metrics
Weather Network Inc
Yamada Science & Art Corp (YSA)

Weighing Equipment

Acron Inc
Boart Longyear Co
K-Tron America
Kistele-Morse
Milttronics Inc
Myriad Industries
Ohaus Corp
Omega Engineering Inc
SEE AD ON PAGE 2
Vibra Screw Inc

Wetlands

ABB Environmental Services Inc
Allied Environmental Consultants Inc
Alton Geoscience Inc
Braun Interfec Corp
Burns & McDonnell Waste Con. Inc
CDM Federal Programs Corp



CDM Camp Dresser & McKee, Inc.
617-621-8181

Camp Dresser & McKee Inc
Chester Environmental
Conti Environmental Inc
Dames & Moore
ERM Group Inc
Environmental Education Enterprises E3
Environmental Science & Engineering Inc
Environmental Technical Services Inc
Foth & Van Dyke
Geraghty & Miller Inc a Heidmij Co
Graef, Anhalt, Schloemer & Associates Inc

Harding Lawson Associates

SEE AD ON PAGE 34
Hazclean Environmental Consultants Inc
High Plains Consortium Inc
Hydro-Terra Inc
Kilam Associates
National Technical Information Service
R E Wright Environmental Inc
Raytheon Environmental Svcs/
Raytheon Engineers & Construction
Rite in the Rain Fieldbooks
S W Cole Engineering Inc
SSOE Inc
Sewall, James W
Walk, Haydel & Associates Inc
Western Water Consultants Inc

PRODUCTS/SERVICES



Mobile Treatment Services

- Water Purification
- Wastewater Treatment
- Chemical Separations
- Trained Technicians
- State of the Art Lab
- R&D Staff

800-238-3028

2070 Airways Blvd., Memphis, TN 38114
Fax: (901) 743-2361; (901) 744-1142

MOBILE PROCESS TECHNOLOGY
Since 1989

A

AAA Environmental
PO 8178
Spartanburg, SC 29305
Phone: 864-582-1222
Fax: 803-583-0709

A & J Management Resources Inc
834-40 W Third St
Lansdale, PA 19446
Phone: 215-393-7454
Natl: 800-847-0128
Fax: 215-393-7457

A O Smith Harvestore Harvestore Drive
DeKalb, IL 60115
Phone: 815-756-1551
Fax: 815-756-7821
SEE AD ON PAGE 29, 74

A C Schultes of NJ, MD, & DE
664 S Evergreen Ave
Woodbury, NJ 08096
Phone: 609-845-5656
Fax: 609-845-1335

A P Buck Inc
7101 Presidents Drive No. 110
Orlando, FL 32809-5649
Phone: 407-851-8602
Fax: 407-851-8910



313-973-3000

A V Systems Inc
4657 Platt Road
Ann Arbor, MI 48108-9726
Phone: 313-973-3000
Fax: 313-677-4480

A&J Environmental Supply
609 16th St
Virginia Beach, VA 23451-4202
Phone: 804-425-8259
Fax: 804-425-7076

AAF Intl
PO Box 35690
Louisville, KY 40232-5690
Phone: 502-637-0011
Natl: 800-477-1214
Fax: 502-637-0321

ABB Air Preheater Inc
PO Box 372
Wellsville, NY 14895
Phone: 716-593-2700
Fax: 716-593-2721
Air Pollution Control; Fume Exhaust System; Heat Exchangers; Heat Recovery Systems; Incineration Systems; Odor Control Equipment; Oxidizers; VOC Removal Systems
SEE AD ON PAGE 45

ABB Air Preheater Inc Ehsam Products
PO Box 339,
2101 N Buckeye
Ablene, TX 67410
Phone: 913-263-4300
Fax: 913-263-3932

ABB Air Preheater Inc Raymond Products
650 Warrenville Road
Usie, IL 60532
Phone: 708-971-2500
Fax: 708-971-1076

ABB Environmental Services Inc
110 Free St, PO Box 7050
Portland, ME 04112
Phone: 207-775-5401
Natl: 800-341-0460
Fax: 207-772-4762

ABB K-Flow Inc
45 Reese Road, PO Box 849
Millville, NJ 08332
Phone: 609-825-5553
Natl: 800-825-3569
Fax: 609-825-1678

ABB Kent Meters Inc
953 NE Osceola Ave
Ocala, FL 34470
Phone: 904-732-4670
Natl: 800-874-0890
Fax: 904-368-1950

ACS Industries Inc
14211 Industry Road
Houston, TX 77053
Phone: 713-434-0934
Natl: 800-231-0077
Fax: 713-433-6201

AFL Industries Inc
3661 W Blue Heron Blvd
Riviera Beach, FL 33404
Phone: 407-844-5200
Natl: 800-807-2709
Fax: 407-844-5246

AGA Gas Inc
6225 Oak Tree Blvd
Cleveland, OH 44131
Phone: 216-573-7800
Natl: 800-424-2427
Fax: 216-573-7870

AGX Inc
50 Progress Ave
Cranberry Township, PA 16066
Phone: 412-776-1905
Natl: 800-249-8330
Fax: 412-776-5714

AMSCO Inc
6490 Stadium Drive,
PO Box 1770
Clemmons, NC 27012
Phone: 910-766-0328
Fax: 910-766-8652

APV Anhydro-Separation Technologies
182 Wales Ave
Tonawanda, NY 14150
Phone: 716-692-3000
Natl: 800-828-7391
Fax: 716-692-6416

APV Heat Transfer Technologies
395 Fillmore Ave
Tonawanda, NY 14150
Phone: 716-692-3000
Natl: 800-828-7391
Fax: 716-692-1715

ASC Professionals
PO Box 681
Roseville, MI 48066
Phone: 810-771-0600
Natl: 800-327-4260
Fax: 810-771-0098

ASOMA/WTC Engineering
11675 Jollyville Road
Austin, TX 78759
Phone: 512-258-6608
Natl: 800-580-6608
Fax: 512-331-9123

Abanaki Corp Oil Skimmer Div
17387 Munn Road
Chagrin Falls, OH 44023
Phone: 216-543-7400
Natl: 800-358-7546
Fax: 216-543-7404

Abresist Corp
5541 N State Rd 13,
PO Box 38
Urbana, IN 46990
Phone: 219-774-3327
Natl: 800-348-0717
Fax: 219-774-8188

AccuStandard Inc
25 Science Park
New Haven, CT 06511
Phone: 203-786-5290
Natl: 800-442-5290
Fax: 203-786-5287

Achieve! Technology Inc
PO Box 668
Amherst, NH 03031-0668
Phone: 603-595-1414
Natl: 800-446-3427
Fax: 603-595-0088

Acron Inc
20 Empire Blvd
Moonachie, NJ 07074
Phone: 201-440-8300
Fax: 201-440-4939

Acromag Inc
30765 Wixom Road
Wixom, MI 48393-7037
Phone: 810-624-1541
Natl: 800-336-8655
Fax: 810-624-9234

Activated Carbon Tech
453 Cranston Drive
Brea, OH 44017-2206
Phone: 216-243-6918

Acutech Plastics Inc
10A MacArthur Road
Reading, PA 19605
Phone: 610-376-4444
Natl: 800-415-0770
Fax: 610-376-4802

Adirondack Environmental Associates Inc
9 Kastner Road
Plattsburgh, NY 12901
Phone: 518-563-5726
Natl: 800-257-3070
Fax: 518-562-0789



Adrian Brown Consultants Inc
155 S Madison St No. 230
Denver, CO 80209
Phone: 303-399-9630
Fax: 303-399-9701

Advanced Air Technology Inc
3800 N Wilke
Arlington Heights, IL 60004
Phone: 708-394-9553
Fax: 708-394-9757

Advanced Containment Systems Inc
11550 Dumas
Houston, TX 77034
Phone: 713-947-9300
Natl: 800-927-2271
Fax: 713-947-8128

Advanced Control Systems Corp
Old Mine Rock Way
Hingham, MA 02043
Phone: 617-740-0223
Fax: 617-740-4227

Advanced Data Systems
20212 - 24th Ave W No. A
Lynnwood, WA 98036
Phone: 206-640-2562
Fax: 206-640-2562

Advanced Pollution Instrumentation Inc
8815 Production Ave
San Diego, CA 92121
Phone: 619-578-2154
Natl: 800-324-5190
Fax: 619-578-1833

Advanced Polymer Sciences Inc
951 Jaycox Road
Avon, OH 44011
Phone: 216-937-6218
Natl: 800-334-7193
Fax: 216-937-5046

Advanced Sensor Devices Inc
430 Ferguson Drive
Bldg No. 3
Mountain View, CA 94043
Phone: 415-960-3007
Fax: 415-960-0127

Adwest Technologies Inc
151 Trapping Brook Road
Wellsville, NY 14895-9465
Phone: 716-593-1405
Fax: 716-593-6614

Aeration Industries Intl Inc
4100 Peavey Road
Chaska, MN 55318
Phone: 612-448-6789
Natl: 800-328-8287
Fax: 612-448-7293

Aero Tec Laboratories Inc
Spear Road Industrial Park
Ramsey, NJ 07446
Phone: 201-825-1400
Natl: 800-526-5330
Fax: 201-825-1962
SEE AD ON PAGE #

Aerocon
69 Academy St
Belleville, NJ 07109
Phone: 215-757-5004
Natl: 800-405-2376
Fax: 215-757-5173



Aeromix Systems Inc
2611 N Second St
Minneapolis, MN 55411
Phone: 612-521-8519
Natl: 800-879-3677
Fax: 612-521-1455



Ag-Chem Equipment Co Inc
5720 Smetana Drive
Minnetonka, MN 55343
Phone: 612-933-9006
Fax: 612-933-7432

Agar Corp Inc
1600 Townhurst
Houston, TX 77043
Phone: 713-464-4451
Fax: 713-464-7741

Air & Waste Management Association
One Gateway Ctr 3rd Floor
Pittsburgh, PA 15222
Phone: 412-232-3444
Fax: 412-232-3450
SEE AD ON PAGE 47

Air Dimensions Inc
1015 W Newport Ct
No. 101
Deerfield Beach, FL 33442
Phone: 954-428-7333
Natl: 800-423-6464
Fax: 954-360-0987

Air Instruments & Measurements Inc
13300 A Brooks Drive
Baldwin, CA 91706
Phone: 818-813-1460
Fax: 818-338-2585

Air Plastics Inc
1224 Castle Drive
Mason, OH 45040
Phone: 513-398-8081
Fax: 513-398-8082

Air Quality Engineering Inc
3340 Winpark Drive
Minneapolis, MN 55427
Phone: 612-544-4426
Natl: 800-328-0787
Fax: 612-544-4013

Air Resource Specialists Inc
1901 Sharp Point Drive No. E
Fort Collins, CO 80525
Phone: 970-484-7941
Fax: 970-484-3423

Air Science Consultants Inc
347 Prestley Road
Bridgeville, PA 15017
Phone: 412-221-6000

Air Source Technologies Inc
11635 W 83rd Terrace
Lenexa, KS 66215
Phone: 913-492-1613
Fax: 913-492-1012

Air Toxics Ltd
180 Blue Ravine Road No. B
Folsom, CA 95630
Phone: 916-985-1000
Natl: 800-985-5955
Fax: 916-985-1020

AirNova Inc
5845 Clayton Ave
Pennsauken, NJ 08109
Phone: 609-486-1500
Natl: 800-747-6682
Fax: 609-486-9896

AirScan Environmental Technologies Inc

197 Meister Ave
Branchburg, NJ 08876
Phone: 908-725-1342
Natl: 800-639-2477
Fax: 908-725-0822

AirSep Corp

290 Creekside Drive
Buffalo, NY 14228-2070
Phone: 716-691-0202
Natl: 800-320-0303
Fax: 716-691-0707

Airex Corp

803 W Angus Ave
Orange, CA 92668
Phone: 714-997-8722
Fax: 714-997-8744

Airmetrics

225 N 5th St No. 501
Springfield, OR 97477-4671
Phone: 503-726-0560
Fax: 503-726-1205

ALAR
708-479-6100

Alar Engineering

9657 196th St
Mokena, IL 60448-9307
Phone: 708-479-6100

Alexander & Associates

9290 Waits Ferry Crossing
Duluth, GA 30155
Phone: 770-729-1114
Fax: 770-729-1114

Alfa Lava Pumps Inc

9201 Wilmot Road
Kenosha, WI 53141
Phone: 414-942-0166
Fax: 414-942-0177

Alfa Lava Thermal Inc

5400 International Trade Drive
Richmond, VA 23231
Phone: 804-222-5300
Natl: 800-248-2532
Fax: 804-236-1360

Alfa Laval Sharpies, Alfa Laval Separation Inc

955 Mearns Road
Warminster, PA 18974
Phone: 215-443-4000
Natl: 800-782-3751
Fax: 215-443-4139

Alken-Murray Corp

1983 Marcus Ave No. C 104
Lake Success, NY 11042
Phone: 516-775-6360
Fax: 516-775-6497

Allegro Industries

6403 E Alondra Blvd
Paramount, CA 90723
Phone: 310-633-4861
Natl: 800-622-3530
Fax: 310-633-2224

Allied Environmental Consultants Inc

4715 NW157th St No. 201
Miami, FL 33014
Phone: 305-626-8826
Fax: 305-626-8819

Allied Signal Inc Automotive & Industrial Catalysts

1301 Main Parkway
Catoosa, OK 74015
Phone: 918-266-4000
Fax: 918-272-4314

Allied Signal Inc Filtration Systems

7 Powder Horn Drive,
PO Box 4904
Warren, NJ 07059-5191
Phone: 908-563-2800
Fax: 908-563-2816

Alligator Inc

935 Queens Road
Charlotte, NC 28207
Phone: 704-376-0398
Fax: 704-332-6602

Alta Resource Mgmt Services Inc

88 B Industry Ave
Springfield, MA 01104
Natl: 800-730-2582
Fax: 413-734-3399

Alternative Remedial Technologies Inc

14497 N Dale Mabry Hwy
No. 140
Tampa, FL 33618
Phone: 813-264-3506
Fax: 813-962-0867

Alton Geoscience Inc

25A Technology Drive
Irvine, CA 92718
Phone: 714-753-0101
Fax: 714-753-0111

Ambi-Tech Safety Brakes

319 Knickerbocker Ave
Hillsdale, NJ 07642
Phone: 201-666-0504
Natl: 800-662-6278
Fax: 201-666-0597

Ambient Engineering Inc

1800 Highway 34
Matawan, NJ 07747
Phone: 908-566-6866
Natl: 800-732-4155
Fax: 908-566-7722

AMERICAN
ENGINEERING
219-892-5151

American Engineering

15886 Michigan Road
Argos, IN 46501
Phone: 219-892-5151
Fax: 219-892-5150

Ameri-Shred Corp

PO Box 46130
Monroeville, PA 15146
Phone: 412-798-7322
Natl: 800-634-8981
Fax: 412-798-7329

American Environmental Instruments Inc

4037 Darling Court No. A
Lilburn, GA 30247
Phone: 770-925-2855
Natl: 800-842-1088
Fax: 770-925-2811

American Gas Products Inc

1513 W Dogwood Ave
Anaheim, CA 92801
Natl: 800-201-6700
Fax: 714-776-6700

American Lewa Inc

132 Hopping Brook Road
Holliston, MA 01746
Phone: 508-429-7403
Fax: 508-429-8615

American Mobile Satellite Corp

10802 Parkridge Blvd
Reston, VA 22091
Phone: 703-758-6000
SEE AD ON PAGE 71

American Pacific Corp/Halotron Inc

3770 Howard Hughes Pkwy
No. 300
Las Vegas, NV 89109
Phone: 702-735-2200
Fax: 702-734-4876

American Pulverizer Co

5540 W Park Ave
St Louis, MO 63110
Phone: 314-781-6100
Fax: 314-781-9209

American Safety & Abatement Products Inc

4354 Clayton Ave
St Louis, MO 63110
Phone: 314-535-8535
Natl: 800-489-8535
Fax: 800-311-6446

American Safety Insurance Group

1900 The Exchange No. 450
Atlanta, GA 30339
Phone: 770-916-1908
Natl: 800-388-3647
Fax: 770-916-0618

American Scientific Instrumentation

107 Hawthorne Ave
Park Ridge, NJ 07656
Phone: 201-391-0922
Fax: 201-391-6804

American Sigma Inc

PO Box 820
Medina, NJ 14103
Phone: 716-798-5580
Natl: 800-635-4567
Fax: 716-798-5599

American Standards Testing Bureau Inc

40 Water St
New York, NY 10004
Phone: 212-943-3160
Natl: 800-221-5170
Fax: 212-825-2250

American Technologies Group Inc

1017 S Mountain Ave
Monrovia, CA 91016
Phone: 818-357-5000
Fax: 818-357-4464

Ameron Fiberglass Pipe

5300 Hollister No. 11
Houston, TX 77040
Phone: 713-690-7777
Natl: 800-370-4377
Fax: 713-690-2842

Ametek Inc Process & Analytical Instruments Div

455 Corporate Blvd
Newark, DE 19702
Phone: 302-456-4400
Natl: 800-537-6044
Fax: 302-456-4444

Ametek Process & Analytical Instruments Div

455 Corporate Blvd
Pencader Corp Ctr
Newark, DE 19702
Phone: 302-456-4412
Natl: 800-222-6789
Fax: 302-456-4444

Analytical Products Group Inc

2730 Washington Blvd
Belpre, OH 45714
Phone: 612-423-4200
Fax: 612-423-5588

Anarad Inc

534 E Ortega St
Santa Barbara, CA 93103
Phone: 805-963-6583
Fax: 805-962-4627

Anatel Corp

2200 Central Ave
Boulder, CO 80301
Phone: 303-442-5533
Natl: 800-373-0531
Fax: 303-447-8365

Andco Environmental Processes Inc

595 Commerce Drive
Buffalo, NY 14228
Phone: 716-691-2100
Fax: 716-691-2880

Andersen 2000 Inc

306 Dividend Drive
Peachtree City, GA 30269
Phone: 770-486-2000
Natl: 800-241-5424
Fax: 770-487-5066



817-465-5611

Andritz-Ruthner Inc

1010 Commercial Blvd S
Arlington, TX 76017
Phone: 817-465-5611
Fax: 817-468-3961

Anguil Environmental Systems Inc

4927 N Lydell Ave
Milwaukee, WI 53217
Phone: 414-332-0230
Fax: 414-332-4375

Anvic Controls

3800 New McEever Road
Acworth, GA 30101
Phone: 770-974-7182
Natl: 800-348-0093
Fax: 770-974-2959



Applied Automation
Hartmann & Brown
918-662-7343

Applied Automation

PO Box 9999
Bartlesville, OK 74005
Phone: 918-662-7343
Fax: 918-662-7052
Monitoring Systems;
Sampling Containers;
Speed Reducers
SEE AD ON PAGE 14, 120

Applied Membranes Inc

110 Bosstick Blvd
San Marcos, CA 92069
Phone: 619-727-3711
Natl: 800-321-9321
Fax: 619-727-4427

Applied Technologies Inc

6395 Gunpark Drive No. E
Boulder, CO 80301
Phone: 303-530-4977
Fax: 303-530-4982

Applied Utility Systems Inc

2042 Business Center Drive
Irvine, CA 92715
Phone: 714-852-3950
Natl: 800-800-3950
Fax: 714-852-3958

Aqua Tech Environmental Laboratories Inc (ATEL)

1776 Marion-Waldo Road
Marion, OH 43302
Phone: 614-382-5991
Natl: 800-783-5991
Fax: 614-383-6010

Aqua-Chem Inc

7800 N 113th St
Milwaukee, WI 53224
Phone: 414-577-2752
Fax: 414-577-2723

Aramco

906 Grace St
Elgin, IL 60120
Phone: 708-741-2220
Natl: 800-767-9981
Fax: 708-741-1218

Areo-Power

Unitized Fueler Inc
103 Smithtown Blvd
Smithtown, NY 11787
Phone: 516-366-4362
Natl: 800-242-2734
Fax: 516-366-0905

Argus Environmental Monitoring

PO Box 689
Roseville, MI 48066-0689
Phone: 810-774-8900
Natl: 800-873-0456
Fax: 810-774-2780

Ariel Research Corp

7910 Woodmont Ave
No. 902
Bethesda, MD 20814
Phone: 301-907-7771
Natl: 800-982-0064
Fax: 301-907-7773

Arizona Instrument Corp

4114 E Wood St
Phoenix, AZ 85040-1941
Phone: 602-470-1414
Natl: 800-528-7411
Fax: 602-470-1888

AS
800-635-7330

Art's Manufacturing & Supply

105 Harrison
American Falls, ID 83211
Phone: 208-226-2017
Natl: 800-635-7330
Fax: 208-226-7280

Arthur Technology Inc

PO Box 1236
Fond du Lac, WI 54936-1236
Phone: 414-922-6970
Natl: 800-328-7518
Fax: 414-922-1085

Asahi/America Inc
19 Green St
Malden, MA 02148
Phone: 617-321-5409
Natl: 800-346-3618
Fax: 617-321-4421

Ashbrook Corp
11600 E Hardy
Houston, TX 77093
Phone: 713-449-0322
Fax: 713-449-1324

Ashland Chemical Co
PO Box 2219
Columbus, OH 43216
Phone: 614-790-3333
Natl: 800-637-7922
Fax: 614-790-3465
**Hazardous Material/Waste;
Hazardous Waste Handling;
Hazardous Waste Recycling;
Hazardous Waste Services;
Hazardous Waste
Transportation; Solvent
Recovery Systems;
Transportation**
SEE AD ON PAGE 7

Assay Technology Inc
1070 E Meadow Circle
Palo Alto, CA 94303
Phone: 415-424-9944
Natl: 800-833-1258
Fax: 415-424-0336

Assmann Corp of America
300 N Taylor Road
Garrett, IN 46738
Phone: 219-357-3181
Fax: 219-357-3738

**Associated Design
& Manufacturing Co**
814 N Henry St
Alexandria, VA 22314
Phone: 703-549-5999
Natl: 800-837-8257
Fax: 703-548-0919

Atkinson Dynamics
405 Eccles Ave S
San Francisco, CA 94080-1964
Phone: 415-583-9845
Fax: 415-876-0111

Atlantic Fluidics Inc
21 South St
Norwalk, CT 06854
Phone: 203-853-7315
Fax: 203-866-8218

Atlantic Screen & Mfg
118 Broadkill Road
Milton, DE 19968
Phone: 302-684-3197
Fax: 302-684-0643

**Atlas Minerals
& Chemicals Inc**
1227 Valley Road,
PO Box 38
Mertztown, PA 19539-0038
Phone: 610-682-7171
Natl: 800-523-8269
Fax: 610-682-9200

Auburn International Inc
PO Box 2008,
8 Electronics Drive
Danvers, MA 01923
Phone: 508-777-2460
Natl: 800-255-5008
Fax: 508-777-8820
**Air Emission Monitoring
Equipment; Baghouse**

**Monitoring; Dust Collector
Accessories/Supplies; Flow
Instrumentation; Leak
Detectors; Monitoring
Systems; Air; Process
Control Instrumentation;
Stack Emission Monitors**
SEE AD ON PAGE 69

**August Mack
Environmental Inc**
8007 Castleton Road
Indianapolis, IN 46250
Phone: 317-579-7400
Natl: 800-579-0770
Fax: 317-579-7410

Aurora Pictures Inc
2525 E Franklin Ave
Minneapolis, MN 55406
Phone: 612-338-2825
Natl: 800-346-9487
Fax: 612-338-2617

**Automatic Switch Co
(ASCO)**
50-60 Hanover Road
Florham Park, NJ 07932
Phone: 201-966-2000
Natl: 800-972-2726
Fax: 201-966-2628

B

B A G Corp
11510 Data Drive
Dallas, TX 75218
Phone: 214-340-7060
Natl: 800-331-9200
Fax: 214-340-4598

B-J Scientific Products Inc
173 Queen Ave SE
Albany, OR 97321
Phone: 541-967-8383
Fax: 641-928-0596

BEE-Line Software
PO Box 59916
Dallas, TX 75229
Phone: 214-233-5463

**BFI (Browning Ferris
Industries Inc)**
757 N Eldridge
Houston, TX 77079
Natl: 800-742-5234
Fax: 713-584-8578

BGI Inc
58 Guinan St
Waltham, MA 02154
Phone: 617-891-9380
Fax: 617-891-8151

BIOS Intl Inc
230 West Parkway
Pompton Plains, NJ 07444
Phone: 201-839-6960
Fax: 201-839-7445

BNA Communications Inc
9439 Key West Ave
Rockville, MD 21716
Phone: 301-294-6770
Natl: 800-233-6067
Fax: 301-948-2085

**BRD Noise &
Vibration Control Inc**
112 Fairview Ave
Wind Gap, PA 18091
Phone: 610-863-6300
Fax: 610-863-4230

**BTG Div of Spectris
Technologies Inc**
2364 Park Central Blvd
Decatur, GA 30035
Phone: 770-981-3998
Natl: 800-624-2326
Fax: 770-808-7818

BTR Instruments
1640 Airport Road
Kennesaw, GA 30144
Phone: 404-919-0557
Fax: 404-428-6335

BVS Inc
Route 322 West
& Poplar Road,
PO Box 250
Honey Brook, PA 19344-0250
Phone: 610-273-2841
Fax: 610-273-2843

Bacharach Inc
625 Alpha Drive
Pittsburgh, PA 15238
Phone: 412-963-2000
Fax: 412-963-2091

Badger Meter Inc
4545 W Brown Deer Road
Milwaukee, WI 53223
Phone: 414-355-0400
Natl: 800-876-3837
Fax: 414-355-2544

Bailey Controls Co
29801 Euclid Ave
Wickliffe, OH 44092
Phone: 216-585-7836
Fax: 216-585-7830

Baker Tanks Inc
19618 S Susana Road
Rancho Dominguez, CA 90221
Phone: 310-763-5766
Natl: 800-225-3712
Fax: 310-763-6476

Baldor Electric Co
5711 R S Boreham Jr St
Fort Smith, AR 72901
Phone: 501-646-4711
Fax: 501-648-5792

Baldwin Environmental Inc
5401 Longley Lane No. 42
Reno, NV 89511
Phone: 702-828-1300
Fax: 702-828-1305

Baler Equipment Co
PO Box 25150
Portland, OR 97225
Phone: 503-292-4118
Natl: 800-426-1723
Fax: 503-297-5991



Barnebey & Sutcliffe Corp
PO Box 2526
Columbus, OH 43216-2526
Phone: 614-258-9501
Natl: 800-886-2272
Fax: 614-258-3464

**Barnes Pumps
Div of Crane Pumps &
Systems**
420 Third St,
PO Box 603
Piqua, OH 45356-0603
Phone: 513-773-2442
Fax: 513-773-2238

Basco Inc
2595 Palmer Ave
University Park, IL 60466
Phone: 708-534-0900
Natl: 800-776-3786
Fax: 708-534-0902

Bay Marketing
PO Box 130
Callander, Ontario,
Canada, CN P0H 1H0
Natl: 800-461-9500

Ben Meadows Co
3589 Broad St
Atlanta, GA 30341
Phone: 770-455-0907
Natl: 800-241-6401
Fax: 800-628-2068

Bennett & Associates Inc
15 Hillside No. 206
Ridgewood, NJ 07450-3628
Phone: 201-670-8707
Fax: 201-670-6493

Bergen Barrel & Drum Co
43-45 O'Brien St
Kearny, NJ 07032
Phone: 201-998-3500
Fax: 201-998-0414

Berman Inc
4070 Leaverton Court
Anaheim, CA 92807
Phone: 714-666-1100
Natl: 800-821-6825
Fax: 714-666-2533

Bete Fog Nozzle Inc
50 Greenfield St
Greenfield, MA 01301
Phone: 413-772-0846
Fax: 413-772-6729

Bicon NE
6801 Cochran Road
Solon, OH 44139
Phone: 216-248-7400
Natl: 800-472-5656
Fax: 216-349-6581

Bilco Co, The
PO Box 1203
New Haven, CT 06505
Phone: 203-934-6363
Fax: 203-933-8478

Bio-Tek Instruments
Box 998 Highland Park
Winooski, VT 05404
Phone: 802-655-4040
Natl: 800-451-5172
Fax: 802-655-7941

**BioGro Div Wheelabrator
Clean Water Systems Inc**
180 Admiral Cochran Drive
No. 305
Annapolis, MD 21401
Phone: 410-224-0022
Fax: 410-224-0152

BioNebraska Inc
3820 NW 46th St
Lincoln, NE 68524
Phone: 402-470-2100
Natl: 800-786-2580
Fax: 402-470-2345

BioTrol Inc
10300 Valley View Road
No. 107
Eden Prairie, MN 55344
Phone: 612-942-8032
Fax: 612-942-8526

BioVir Laboratories Inc
685 Stone Road
Benicia, CA 94510
Phone: 707-747-5906
Natl: 800-442-4642
Fax: 707-747-1751

Biomarine
456 Creamery Way
Exton, PA 19341-2532
Phone: 610-524-8800
Fax: 610-524-8807

Bioprime Ltd
PO Box 716
Norwich, VT 05055
Phone: 802-649-0227
Natl: 800-366-9141
Fax: 802-649-2238

Bioscience Inc
1550 Valley Center Parkway
No. 140
Bethlehem, PA 18017
Phone: 610-974-9693
Natl: 800-627-3069
Fax: 610-691-2170

Biosystems Inc
PO Box 158
Rockfall, CT 06480
Phone: 203-344-1079
Fax: 203-344-1068

Bird Machine Co Inc
100 Neponset St
S Walpole, MA 02071
Phone: 508-668-0400
Fax: 508-660-2461

Bird-X Inc
300 N Elizabeth St
Dept EP
Chicago, IL 60607
Phone: 312-226-2473
Natl: 800-662-5021
Fax: 312-226-2480

**Blackmer/A Dover
Resources Co**
1809 Century Ave SW
Grand Rapids, MI 49509
Phone: 616-241-1611
Fax: 616-241-3752

Biasland Bouck & Lee Inc
6723 Towpath Road,
PO Box 66
Syracuse, NY 13214-0066
Phone: 315-446-9120
Fax: 315-449-0017

Blower Application Co Inc
N114 W19125 Clinton Drive
Germantown, WI 53022
Phone: 414-255-5580
Fax: 414-255-3446

Blue-White Industries
14931 Chestnut St
Westminster, CA 92683
Phone: 714-893-8529
Fax: 714-894-9492

Blymyer Engineers Inc
1829 Clement Ave
Alameda, CA 94705
Phone: 510-521-3773
Natl: 800-753-3773
Fax: 510-865-2594

Boart Longyear Co
2175 West Park Court
Stone Mountain, GA 30087
Phone: 770-469-2720
Natl: 800-241-9468
Fax: 770-498-2841

Boston Gear

14 Hayward St
Quincy, MA 02171
Phone: 617-328-3300
Natl: 800-225-5280
Fax: 617-479-6238

Bovar Environmental

1600 555-Fourth Ave SW
Calgary, Alberta,
Canada, CN T2P 3E7
Phone: 403-264-2140
Fax: 403-237-7634

Bowerston Shale Co, The

PO Box 199
Bowerston, OH 44695
Phone: 614-269-2921
Fax: 614-269-5456

Brady USA Inc

Signmark Div
PO Box 2999
Milwaukee, WI 53201-2999
Phone: 414-228-1411
Natl: 800-368-3374
Fax: 800-221-6880

Brailsford & Co Inc

670 Milton Road
Rye, NY 10580
Phone: 914-967-1820
Fax: 914-967-1836

Braun Intertec Corp

PO Box 39108
Minneapolis, MN 55439-0108
Phone: 612-946-6000
Natl: 800-279-6100
Fax: 612-946-6190

Brinkmann Instruments Inc

One Cantiague Road,
PO Box 1019
Westbury, NY 11590-0207
Phone: 516-334-7500
Natl: 800-645-3050
Fax: 516-334-7506

Brooklyn Thermometer Co Inc

90 Verdi St
Farmingdale, NY 11735
Phone: 516-694-7610
Fax: 516-694-6329

Brooks Instrument

407 W Vine St
Hatfield, PA 19440
Phone: 215-362-3500
Fax: 215-362-3745

Brown & Caldwell

PO Box 8045
Walnut Creek, CA 94596-1220
Phone: 510-937-9010
Fax: 510-937-9026

Brown Bear Corp

PO Box 29
Corning, IA 50841
Phone: 515-322-4220
Fax: 515-322-3527
SEE AD ON PAGE 46, 84

Brown-Minneapolis Tank

PO Box 64670
St Paul, MN 55164
Phone: 612-454-6750
Natl: 800-678-2657
Fax: 612-454-1987

Bruel & Kjaer Instruments Inc

2364 Park Central Blvd
Decatur, GA 30035
Phone: 770-981-3998
Natl: 800-332-2040
Fax: 770-808-7818

Bryan Steam Corp

PO Box 27,
State Rd 19 N
Reno, IN 46970
Phone: 317-473-6651
Fax: 317-473-3074

Buck Scientific Inc

58 Fort Point St
E Norwalk, CT 06855
Phone: 203-853-9444
Natl: 800-562-5566
Fax: 203-853-0569

Burns & McDonnell

Waste Consultants Inc
10881 Lowell Ave
Overland Park, KS 66210
Phone: 813-333-8787
Fax: 813-822-3463

Busch Inc

516 Viking Drive
Virginia Beach, VA 23452
Phone: 804-463-7800
Natl: 800-842-7867
Fax: 804-463-7407

C

C H Hanson Co, The

3630 N Wolf Road
Franklin Park, IL 60131
Phone: 708-451-0500
Natl: 800-837-3398
Fax: 708-451-7711

CAE Instrumental Rental

246 Woodwork Lane
Palatine, IL 60067
Phone: 708-934-8668
Natl: 800-553-5511
Fax: 708-934-8260

CDM Federal

Programs Corp
13135 Lee Jackson Hwy
No. 200
Fairfax, VA 22033
Phone: 703-968-0900
Fax: 703-968-0915

CDS Analytical Inc

PO Box 277
Oxford, PA 19363-0277
Phone: 610-932-3636
Fax: 610-632-4158

CEA Instruments Inc

16 Chestnut St
Emerson, NJ 07630
Phone: 201-967-5660
Fax: 201-967-8450

CEM Corp

PO Box 200,
3100 Smith Farm Road
Matthews, NC 28106
Phone: 704-821-7015
Natl: 800-726-3331
Fax: 704-821-8710

CH & E Mfg Co Inc

3849 N Palmer St
Milwaukee, WI 53212
Phone: 414-964-3400
Natl: 800-236-0666
Fax: 414-964-0677

CINC

3535-B Arrowhead Drive
Carson City, NV 89706
Natl: 800-380-2462
SEE AD ON PAGE 25

CLA-VAL Co

PO Box 1325
Newport Beach, CA 92659
Phone: 714-722-4800
Natl: 800-942-6326
Fax: 714-548-5441

CMS Industries Inc

PO Box 889
Stanton, CA 90680
Phone: 714-891-1196
Natl: 800-367-2526
Fax: 714-891-4937

CNA Insurance

CNA Plaza
Chicago, IL 60685
Phone: 312-822-4250
Fax: 312-822-2418
SEE AD ON PAGE 4, 107

CSF Treatment Systems Inc

8405 SW Nimbus Ave
Beaverton, OR 97008
Phone: 503-644-8220
Fax: 503-826-0775

CTL Environmental Services

24404 S Vermont Ave
No. 307
Harbor City, CA 90710
Phone: 310-530-5006
Natl: 800-777-0605
Fax: 310-530-0792

CVM Corp

402 Vandever Ave
Wilmington, DE 19802
Phone: 302-654-7070
Fax: 302-654-2772

CVT America LLC

4100 Quakerbridge Road
Lawrenceville, NJ 08648
Phone: 609-935-0075
Fax: 609-936-0085

Cabot Safety Corp

One Washington Mall
Boston, MA 02108-2610
Phone: 317-692-6616
Natl: 800-225-9038
Fax: 317-692-6775

Calgon Carbon Corp

PO Box 717
Pittsburgh, PA 15230-0717
Phone: 412-787-6700
Natl: 800-422-7266
Fax: 412-787-6682

California Analytical

Instruments Inc
1238 W Grove Ave
Orange, CA 92665
Phone: 714-974-5560
Fax: 714-921-2531

Camber Corp

602 McKnight Park Drive
Pittsburgh, PA 15237
Phone: 412-367-8626
Fax: 412-367-1388

Cameron Environmental Inc

527 Van Ness Ave
Torrance, CA 90501
Phone: 310-212-0610
Natl: 800-507-3228
Fax: 310-212-7222

Cameron-Yakima Inc

PO Box 1554
Yakima, WA 98907
Phone: 509-452-6605
Fax: 509-453-9912

Camp Dresser

& McKee Inc
One Cambridge Center
Cambridge, MA 02142
Phone: 617-621-8181
Natl: 800-243-2677
Fax: 617-577-7501

Campbell Scientific Inc

815 W 1800 N
Logan, UT 84321-1784
Phone: 801-753-2342
Fax: 801-750-9540

Capital Controls Co Inc

3000 Advance Lane
Colmar, PA 18915
Phone: 215-997-4000
Fax: 215-997-4062

Capsule Environmental

Engineering Inc
1970 Oakcrest Ave
No. 215
St Paul, MN 55113
Phone: 613-636-2644
Natl: 800-328-8246
Fax: 613-636-3106

Carbon Activated

1662 W 139th St
Gardena, CA 90249
Phone: 310-323-8132
Fax: 310-323-8366

Carbonair Environmental

Systems Inc
8640 Monticello Lane
Maple Grove, MN 55369
Phone: 612-425-2992
Natl: 800-526-4999
Fax: 612-425-6882

Carbort Corp

51 Riverside Ave
Westport, CT 06880
Phone: 203-226-5642
Natl: 800-242-1150
Fax: 203-226-5322

Cartwright

onsulting Co
8324-16th Ave S
Minneapolis, MN 55425
Phone: 612-854-4911
Fax: 612-854-6964

Cedarapids Inc

A Raytheon Co
916 Sixteenth St NE
Cedar Rapids, IA 52402
Phone: 316-363-3511
Fax: 316-399-4871

Celcote Air

Pollution Control
PO Box 811630
Cleveland, OH 44181-1630
Phone: 216-243-0700
Fax: 216-243-9854

Celite Corp

PO Box 519
Lompoc, CA 93438
Natl: 800-342-8667
Fax: 805-735-5699

Century West

Environmental Inc
2227 Portola Road
No. B
Ventura, CA 93003
Phone: 805-642-8137
Fax: 805-642-5128

Challenge Environmental

Systems Inc
PO Box 3671
Fayetteville, AR 72702
Phone: 913-681-3913
Fax: 913-681-3913

Chem Service Inc

PO Box 3108,
660 Tower Lane
West Chester, PA 19381
Phone: 610-692-3026
Natl: 800-452-9994
Fax: 610-692-8729

Chem-Tainer Industries

361 Neptune Ave
West Babylon, NY 11704
Phone: 516-661-8300
Natl: 800-275-2436
Fax: 516-661-8209

Chem-Tex Corp

550 W Ingham Ave
Trenton, NJ 08638
Phone: 609-392-6770
Fax: 609-392-7506

Chemco

Manufacturing Co Inc
3175 Mac Arthur Blvd
Northbrook, IL 60062
Phone: 708-480-7700
Natl: 800-323-0431
Fax: 708-480-7706

Chemetrics Inc

Route 28
Calverton, VA 22016
Phone: 540-788-9026
Natl: 800-356-7072
Fax: 540-788-4856

Chemgrate Corp

19240-144th Ave NE
Woodinville, WA 98072
Phone: 206-483-9797
Natl: 800-345-5636
Fax: 206-481-3622



Chemguard Corp, The

2775 Norton Creek Drive
W Chicago, IL 60185-6411
Phone: 708-377-4800
Fax: 708-584-1774

Chemical Lime Co

PO Box 121874
Fort Worth, TX 76121-1874
Phone: 817-732-8164
Natl: 800-365-6724
Fax: 817-732-8564

Chemical Safety Corp

1301 S 46th St Bldg 180
Richmond, CA 94804
Phone: 510-231-9490
Fax: 510-233-8926

Chemineer Inc

PO Box 1123
Dayton, OH 45401
Phone: 513-454-3200
Fax: 513-454-3379

Chemtrol Div of Nibco Inc

5250 W 75th St
Indianapolis, IN 46268
Phone: 317-871-5717
Natl: 800-343-5455
Fax: 317-871-5711

COMPANY PROFILES

Chester Environmental
600 Clubhouse Drive
Moon Township, PA 15108
Phone: 412-269-5700
Natl: 800-337-0777
Fax: 412-269-5479

Chief Industries Inc
PO Box 2078
Grand Island, NE 68802-2078
Phone: 308-382-8820
Fax: 308-389-7448

Childers Products Co
35555 Curtis Blvd
Eastlake, OH 44095
Phone: 216-953-5200
Natl: 800-321-7994
Fax: 216-953-0638

Chlorinator Inc
4125 SW Martin Hwy No. 2
Palm City, FL 34990
Phone: 407-288-4854
Natl: 800-327-9761
Fax: 407-287-3238

ChromatoChem Inc
2837 Fort Missoula Road
Missoula, MT 59801-7407
Phone: 406-728-5897
Fax: 406-728-5924

Citation Publishing Inc (CPI)
1435 N Hayden Road
Scottsdale, AZ 85257
Phone: 602-994-4560
Natl: 800-808-3372
Fax: 602-994-4456
Computer Software, Regulatory
SEE AD ON PAGE 9, 119

Civacon
4595 E Tech Drive
Cincinnati, OH 45245
Phone: 513-528-2700
Natl: 800-526-5657
Fax: 513-528-7802

Clamshell Buildings Inc
1990 Knoll Drive
Ventura, CA 93003
Phone: 805-650-1700
Fax: 805-650-1733

Clark Boardman Callaghan
375 Hudson St
New York, NY 10014
Natl: 800-890-5558
Fax: 212-229-9372

Clean Air Engineering
500 W Wood St
Palatine, IL 60067
Phone: 708-991-3300
Natl: 800-627-0033
Fax: 708-991-0036



Clean Gas Systems Inc
160-2 Remington Blvd
Ronkonkoma, NY 11779
Phone: 516-467-1600
Fax: 516-467-1688

Clean Harbors Environmental Services Inc
235 Wood Road
Braintree, MA 02184
Phone: 617-849-1800
Natl: 800-282-0058
Fax: 617-848-1632

Clean Soil Inc
PO Box 23391
Columbia, SC 29224
Phone: 803-699-0413
Fax: 803-699-0413

Clean World Engineering Ltd
1776 S Naperville Road
No. 102 B
Wheaton, IL 60187
Phone: 708-260-0200
Natl: 800-761-9603
Fax: 708-260-0797

Clements Associates Inc
1992 Hunter Ave
Newton, IA 50208
Phone: 515-792-8285
Natl: 800-247-6630
Fax: 515-792-1361

Climatronics Corp
140 Wilbur Place
Bohemia, NY 11716
Phone: 516-567-7300
Fax: 516-567-7585

Coastal Environmental Systems
1000 First Ave S
Second Floor
Seattle, WA 98134-1216
Phone: 206-682-6048
Natl: 800-488-8291
Fax: 206-682-5658

Coastal Leasing Inc
179 Sidney St
Cambridge, MA 02139
Phone: 617-497-1122
Fax: 617-497-1188

College Research Corp (CORECO)
N116 W16800 Main St,
PO Box 577
Germantown, WI 53022
Phone: 414-255-4700
Fax: 414-255-5283

Colloid Environmental Technologies Co
1350 W Shure Drive
Arlington Heights, IL 60004
Phone: 708-392-5800
Natl: 800-527-9948
Fax: 708-506-6150

Columbia Scientific
PO Box 203190,
11950 Jollyville Road
Austin, TX 78720-3190
Phone: 512-258-5191
Natl: 800-531-5003
Fax: 512-258-5004



Columbian Steel Tank Co
PO Box 2907
Kansas City, KS 66110
Phone: 913-621-3700
Fax: 913-621-2145

Columbus Instruments
950 N Hague Ave
Columbus, OH 43204-2121
Phone: 614-276-0861
Natl: 800-669-5011
Fax: 614-276-0529

Comco Inc
17120 Clark Ave
Bellflower, CA 90706-5730
Phone: 310-804-0305
Fax: 310-925-4248

Compacting Technologies
2417 NW Thurman
Portland, OR 97210
Phone: 503-228-0719
Natl: 800-727-2067
Fax: 503-228-0873

Computalog
500 Winscott Road
Ft Worth, TX 76126
Phone: 817-249-7200
Fax: 817-249-7222

Computational Mechanics Inc
25 Bridge St
Billerica, MA 01821
Phone: 508-667-5841
Fax: 508-667-7582

Con-Test/ATC Environmental Inc
39 Spruce St E
Longmeadow, MA 01028
Phone: 413-525-1198
Natl: 800-634-8165
Fax: 413-525-8227

Con/Span Bridge Systems
3100 Research Blvd,
PO Box 20266
Dayton, OH 45420-0266
Phone: 513-254-2233
Natl: 800-526-3999
Fax: 513-254-8365

Conatech Consulting Group Inc
287 N Lindbergh Blvd
No. 208
Creve Coeur, MO 63141-7849
Phone: 314-995-9767
Fax: 314-995-9766

Concrete Systems Inc
Commercial Ave
Hudson, NH 03051
Phone: 603-889-4163
Natl: 800-342-3374
Fax: 603-889-2417

Containment Corp
10889 Portal Drive
Los Alamitos, CA 90720
Phone: 714-821-6570
Natl: 800-235-7421
Fax: 714-821-9949

Containment Systems
605 Townsend Road
Cocoa, FL 32926
Phone: 407-632-5640
Natl: 800-282-4584
Fax: 407-639-4017

Conti Environmental Inc
3001 S Clinton Ave
South Plainfield, NJ 07080
Phone: 908-561-9025
Fax: 908-754-3283

Control Electronics Inc
Mount View Road
Morgantown, PA 19543
Phone: 610-286-6018
Fax: 610-286-5821

Control Instruments Corp
25 Law Drive
Fairfield, NJ 07004
Phone: 201-575-9114
Fax: 201-575-0013

Controlotron
155 Plant Ave
Hauppauge, NY 11788
Phone: 516-231-3600
Fax: 516-231-3334

Convault Inc
4109 Deering Road
Denair, CA 95316
Phone: 209-632-7571
Natl: 800-222-7099
Fax: 209-632-4711

Cook Screen Technologies Inc
1292 Glendale-Milford Road
Cincinnati, OH 45215
Phone: 513-771-9192
Natl: 800-743-9355
Fax: 513-771-2665

Corbus A Div of CMS Inc
206 Line Road
Kennett Square, PA 19348
Phone: 610-444-5691
Natl: 800-524-7096
Fax: 610-444-6461

Cornell Pump Co
2323 SE Harvester Drive
Portland, OR 97222-7592
Phone: 503-653-0330
Fax: 503-653-0338

Cortec Corp
4119 White Bear Parkway
St Paul, MN 55110
Phone: 612-429-1100
Natl: 800-426-7832
Fax: 612-429-1122

Cosysco Inc
PO Box 4837
Walnut Creek, CA 94596
Phone: 510-947-5756
Fax: 510-930-8472

Croll Reynolds Co Inc
751 Central Ave,
PO Box 668
Westfield, NJ 07091
Phone: 908-232-4200
Fax: 908-232-2146

Crompton & Knowles Colors Inc
PO Box 33188
Charlotte, NC 28233
Phone: 704-372-5890
Natl: 800-438-4122
Fax: 704-372-1522

Crompton Instruments Ltd
2717 Rena Road
Mississauga, Ontario,
Canada, CN L4T 3K1
Phone: 905-671-2253
Fax: 905-672-2617

Crompton Instruments NA
1640 Airport Road
Kennesaw, GA 30144
Phone: 770-428-6355
Fax: 770-423-7194

Crown Technology Inc
PO Box 50426,
7513 E 96th St
Indianapolis, IN 46250-0426
Phone: 317-845-0045
Natl: 800-432-0045
Fax: 317-845-9086

Culligan Intl
One Culligan Parkway
Northbrook, IL 60062
Phone: 708-205-5730
Natl: 800-451-3260
Fax: 708-205-6066

Cura Inc
2735 Villa Creek Drive
No. 245
Dallas, TX 75240
Phone: 214-620-7117
Natl: 800-486-7117
Fax: 214-620-8219

Cushman
PO Box 82409
Lincoln, NE 68501-2409
Phone: 402-475-9581
Natl: 800-228-4444
Fax: 402-474-8700

Custom Switches
PO Box 111
Manuel, TX 77578
Phone: 713-489-7844
Fax: 713-489-7521

Cytec Industries Inc
Five Carrel Mountain Plaza
West Paterson, NJ 07424
Phone: 201-357-3275
Fax: 201-357-3065



D G Supplies Inc
PO Box 400
Dayton, NJ 08810
Phone: 609-860-0003
Natl: 800-347-7879
Fax: 609-860-0285

DBS Manufacturing Inc
5421 Hillside Drive
Forest Park, GA 30050
Phone: 404-768-2131
Natl: 800-327-7010
Fax: 404-761-7225

DEL Industries
3428 Bullock Ln
San Luis Obispo, CA 93401
Phone: 805-541-1601
Natl: 800-676-1335
Fax: 805-541-8459

DNV Technica
40925 County Center Drive
No. 200
Temecula, CA 92591
Phone: 909-694-5790
Fax: 909-694-5799

DPIC Companies
2959 Monterey-Salinas Hwy
Monterey, CA 93940
Phone: 408-649-5522
Natl: 800-227-8533
Fax: 408-649-3958

DRE Technologies
111 Westwood Place
No. 420
Brentwood, TN 37027
Phone: 615-373-1373
Fax: 615-373-3107

Dakota Software Corp
7 Tobey Village Office Park
Pittsford, NY 14534
Phone: 716-381-8710
Natl: 800-926-6759
Fax: 716-381-1614

Dames & Moore

911 Wilshire Blvd No. 700
Los Angeles, CA 90017
Phone: 213-683-1560
Natl: 800-448-1938
Fax: 213-628-0015

Dampney Co Inc

85 Paris St
Everett, MA 02149
Phone: 617-389-2805
Fax: 617-389-0484

Danatec Educational Services Ltd

1410-800 Sixth Ave SW
Calgary, Alberta,
Canada, CN T2P 3G3
Phone: 403-232-6950
Natl: 800-465-3366
Fax: 403-232-6952

Dancer Communications Inc

649 South Ave Bldg No. 6
Secane, PA 19018
Phone: 610-543-8066
Fax: 610-543-2151

Dasibi Environmental Corp

506 Paula Ave
Glendale, CA 91201
Phone: 818-247-7601
Fax: 818-247-7614

Davco Div Davis Water & Waste Industries Inc

1828 Metcalf Ave
Thomasville, GA 31792
Phone: 912-226-5733
Natl: 800-841-1550
Fax: 912-228-0312

David Clark Co Inc

360 Franklin St,
Box 15054
Worcester, MA 01615-0054
Phone: 508-751-5800
Fax: 508-753-5827

Davis Instruments

3465 Diablo Ave
Hayward, CA 94545
Phone: 510-732-9229
Natl: 800-678-3669
Fax: 510-732-9188

Davis Process Div

2650 Tallevast Road
Tallevast, FL 34270-0029
Phone: 941-355-2971
Natl: 800-345-3982
Fax: 941-351-4756

DeMarco MAX VAC Corp

674 S County Line Road
Bensenville, IL 60106
Phone: 708-766-1119
Fax: 708-766-1077

Dean Pump Div Met-Pro Corp

PO Box 68172
Indianapolis, IN 46268-0172
Phone: 317-293-2930
Fax: 317-297-7028

Decade Software Co

1218 W Paul Ave
Fresno, CA 93711
Phone: 209-438-4004
Natl: 800-372-3632
Fax: 209-431-2923

Dedert Corp

20000 Governors Drive
Olympia Fields, IL 60461-1074
Phone: 708-747-7000
Fax: 708-755-8815

Deep Shaft Technology Inc

700, 1207 - 11th Ave SW
Calgary, Alberta,
Canada, CN T3C 0M5
Phone: 403-244-5340
Natl: 800-661-9471
Fax: 403-245-5156

Deere Power Systems

PO Box 5100
Waterloo, IA 50704-5100
Phone: 319-292-6060
Natl: 800-533-6446
Fax: 319-292-5075

Degussa Stationary Emission Control Catalyst

5314 S Yale Ave No. 504
Tulsa, OK 74135
Phone: 918-491-7475
Fax: 918-491-7480

Del Mar Scientific Inc

PO Box 486
Addison, TX 75001
Phone: 214-661-5160
Fax: 214-490-9243

Delta Cooling Towers Inc

134 Clinton Road
Fairfield, NJ 07004-2970
Phone: 201-227-0300
Natl: 800-289-3358
Fax: 201-227-0458

Delta Environmental Consultants Inc

3900 Northwoods Drive
St Paul, MN 55112
Phone: 612-486-8022
Natl: 800-477-7411
Fax: 612-486-0769

Deltech Engineering Inc

344 Churchmans Road
New Castle, DE 19720
Phone: 302-328-1345
Fax: 302-328-4833

Densorex

11661 Seaboard Circle
Stanton, CA 90680
Phone: 714-895-4344
Fax: 714-894-4839

**Desalination Systems Inc**

760 Shadowridge Drive
Vista, CA 92083
Phone: 619-598-3334
Fax: 619-598-3335

Detcon Inc

2408 Timberloch Place
No. D1
The Woodlands, TX 77380
Phone: 713-367-4100
Fax: 713-292-2860

Dieterich Standard

PO Box 900
Boulder, CO 80301
Phone: 303-530-9600
Fax: 303-530-7064
SEE AD ON PAGE 48

Diagenex Inc

288 Lindbergh Ave
Livermore, CA 94550
Phone: 510-606-5600
Fax: 510-606-5600

Diagraph Corp

3401 Rider Trail S
Earth City/St Louis,
MO 63045-1110
Phone: 314-739-1221
Natl: 800-521-3047
Fax: 314-770-5748

DigiCOURSE Inc

3120 Rogerdale Road
No. 150
Houston, TX 77042
Phone: 713-784-4292
Fax: 713-784-6961

Digitronics Sixnet

PO Box 767
Clifton Park, NY 12065
Phone: 518-877-5173
Fax: 518-877-8346

Direct Safety Co

7815 46th St
Phoenix, AZ 85044
Phone: 603-968-6231
Natl: 800-528-7405
Fax: 602-438-1690

Dival Safety Equipment

1721 Niagara St
Buffalo, NY 14207
Phone: 716-874-9060
Natl: 800-343-1351
Fax: 716-874-4686

Diversified Well Products Inc

2176 N Pacific St
Orange, CA 92665
Phone: 714-637-2383
Natl: 800-225-9355
Fax: 714-637-2431

Dixon Information Inc

78 W 3300 S
Salt Lake, UT 84115-3013
Phone: 801-486-0800
Fax: 801-486-0849

Dodgen Mobile Technologies

PO Box 39,
Highway 169 North
Humboldt, IA 50548
Phone: 515-332-3755
Natl: 800-247-1835
Fax: 515-332-3756

Donley Technology

PO Box 152,
220 Garfield Ave
Colonial Beach, VA 22443
Phone: 804-224-9427
Fax: 804-224-7958

Dow Plastic-Lined Piping Products

PO Box 927
Bay City, MI 48707-0927
Phone: 517-638-2500
Natl: 800-233-7577
Fax: 517-638-0522

Drexelbrook Engineering Co

205 Keith Valley Road
Horsham, PA 19044
Phone: 215-674-1234
Fax: 215-674-2731

Drip Free Packing Co

PO Box 66795
St Petersburg Beach, FL 33736
Phone: 813-345-3354
Fax: 813-343-1211

Drums Inc

3511 Third Ave E
Tampa, FL 33605
Phone: 813-241-4800
Fax: 813-241-0700

Dual Div Met-Pro Corp

1550 Industrial Drive
Owosso, MI 48867
Phone: 517-725-8184
Fax: 517-725-8188

Ducon Environmental Systems Inc

110 Bi-County Blvd
Farmingdale, NY 11735
Phone: 513-420-4900
Fax: 516-420-4985

Dudick Inc

1818 Miller Parkway
Streetsboro, OH 44241
Phone: 216-562-1970
Natl: 800-322-1970
Fax: 216-562-7368

Duriron Co Inc

PO Box 8820
Dayton, OH 45401
Phone: 513-226-4000
Fax: 513-226-4325

**Durr Environmental Systems**

40600 Plymouth Road
Plymouth, MI 48170-4297
Phone: 313-459-6800
Fax: 313-459-5837

Dustvent Inc

100 W Fay St
Addison, IL 60101
Phone: 630-543-9007
Natl: 800-553-9007
Fax: 630-543-1407

Dwyer Instruments Inc

PO Box 373
Michigan City, IN 46361
Phone: 219-879-8000
Fax: 219-872-9057

Dyna-FID Inc

131 Wallace Ave No. 2
Downtown, PA 19335
Phone: 610-873-7824
Fax: 610-873-9506

DynaVac

30 Woodrock Road,
PO Box 890238
Weymouth, MA 02189
Phone: 617-337-4111
Fax: 617-337-5145

Dynasonics Inc

3535 SW Corporate Parkway
Palm City, FL 34990
Natl: 800-535-3569
Fax: 407-287-0011

Dyncorp Environmental Energy & Natl Security Programs

300 N Lee St No. 500
Alexandria, VA 22314
Phone: 703-519-1472
Fax: 703-548-4766

**Dynecol Inc**

6520 Georgia St
Detroit, MI 48211
Phone: 313-571-7441
Fax: 313-571-7190

**E J Krause & Associates 7315 Wisconsin Ave No 450 N Bethesda, MD 29814**

Phone: 301-986-7800
Fax: 301-986-4538
SEE AD ON PAGE 37

M Science

480 Democrat Road
Gibbstown, NJ 08027
Natl: 800-222-0342
Fax: 609-423-4389

E S Industries

701 S Route 73
Berlin, NJ 08009
Phone: 609-753-8400
Natl: 800-356-6140
Fax: 609-753-8484

E-N-G Mobile Systems Inc

2245 Via De Mercados
Concord, CA 94520
Phone: 510-798-4060
Natl: 800-662-4522
Fax: 510-798-0152

E-Soft Inc

6000 Dawson Blvd No. L
Norcross, GA 30093
Phone: 770-840-1108
Natl: 800-844-1400
Fax: 770-840-7020

EAS Laboratories

105 Commercial St
Watertown, CT 06795
Phone: 860-274-5461
Fax: 860-945-0449

EBW Inc

2814 McCracken Ave
Muskegon, MI 49841
Phone: 616-755-1671
Natl: 800-475-5151
Fax: 616-755-7201

ECO Purification Systems USA Inc

8813 Waltham Woods Rd
No. 304
Baltimore, MD 21234
Phone: 410-882-1566
Fax: 410-882-2910

ECS Underwriting Inc

520 Eagleview Blvd
Exton, PA 19341
Phone: 610-458-0570
Natl: 800-327-1414
Fax: 610-458-8667
SEE AD ON PAGE 55

EET Inc

4710 Bellaire Blvd
No. 300
Bellaire, TX 77401
Phone: 713-662-0727
Fax: 713-662-2322

EFA Technologies Inc
1611 20th St
Sacramento, CA 95814
Phone: 916-443-8842
Natl: 800-332-7712
Fax: 916-443-3759

EG & G Rotron - Industrial Products Div
North St
Saugerties, NY 12477
Phone: 914-246-3401
Fax: 914-246-3802

EIMCO Process Equipment
PO Box 300
Salt Lake City, UT 84110
Phone: 901-526-2000
Fax: 801-526-2425

EIT
251 Welsh Pool Road
Exton, PA 19341
Phone: 610-363-5450
Fax: 610-363-0167



EKTO Mfg Cor
Eagle Drive
Sanford, ME 04073
Phone: 207-324-4427
Fax: 207-324-4667

ELB & Associates Inc
605 Eastowne Drive
Chapel Hill, NC 27514
Phone: 919-967-2228
Natl: 800-334-5478
Fax: 919-493-2263

ELE Int'l Inc/Soiltest Products Div
PO Box 8004,
86 Albrecht Drive
Lake Bluff, IL 60044-8004
Phone: 708-295-9400
Natl: 800-323-1242
Fax: 708-295-9414

EMC Equipment Manufacturing Corp
2615 Pacific Park Drive
Whittier, CA 90601
Phone: 310-908-7696
Fax: 310-908-7698

EMCO Flowmeters
600 Diagonal Highway
Longmont, CO 80501
Phone: 303-651-0550
Fax: 303-678-7152

EMI Inc
Heritage Park Road,
PO Box 912
Clinton, CT 06413
Phone: 860-669-1199
Natl: 800-243-1188
Fax: 860-669-7461

EMS Environmental Monitor Service
PO Box 4340,
380 Main St
Yalesville, CT 06492
Phone: 203-265-0598
Natl: 800-864-2814
Fax: 203-269-4574

ENSR
35 Nagog Park
Acton, MA 01720
Phone: 508-635-9500
Natl: 800-722-2440
Fax: 508-635-9180

EP Container Corp. 800-211-0311

EP Container Corp
12241 Industry St
Garden Grove, CA 92641
Phone: 714-897-7725
Natl: 800-211-0311
Fax: 714-898-6115

EPG Companies
PO Box 224, 9060 Zachary Lane No. 115
Maple Grove, MN 55369
Phone: 612-424-2613
Natl: 800-443-7426
Fax: 612-493-4812

ERASE Inc
2 Pleasant Ave
Clifton, NJ 07013
Phone: 201-778-7055
Fax: 201-778-4854



ERM Group Inc
855 Springdale Drive
Exton, PA 19341
Natl: 800-544-3117
Fax: 610-524-7335

ESSC (Earth Systems & Solutions Corp)
PO Box 589
Bracey, VA 23919
Phone: 804-636-5927
Fax: 804-636-5928

Eagle Point Software
4131 Westmark Drive
Dubuque, IA 52005-2627
Phone: 319-556-8392
Natl: 800-678-6565
Fax: 319-556-53213

Eagle-Picher/E S A T
200 B J Tunnell Blvd E
Miami, OK 74354
Natl: 800-331-7425
Fax: 918-540-1604

Earmark Inc
1125 Dixwell Ave
Hamden, CT 06514
Phone: 203-777-2130
Fax: 203-777-2886

Earth Info Inc
5541 Central Ave
Boulder, CO 80301
Phone: 303-938-1788
Fax: 303-938-8183

Earth Remediation Services Inc
21 Business Park Drive
Brantford, CT 06405
Phone: 203-488-6713
Fax: 203-488-3628

Easi-Set Industries
PO Box 300
Midland, VA 22728
Phone: 540-439-8911
Natl: 800-547-4045
Fax: 540-439-1232

Eckenfelder Inc
227 French Landing Drive
Nashville, TN 37228
Phone: 615-255-2288
Fax: 615-256-8332

Eclipse Combustion Inc
1665 Elmwood Road
Rockford, IL 61103
Phone: 815-877-3031
Fax: 815-877-3336

EcoAnalysis Inc
221 E Matilija St No. A
Ojai, CA 93023
Phone: 805-646-1461
Natl: 800-646-1461
Fax: 805-646-4141

Ecom America
3075 Breckenridge Blvd
No. 420
Duluth, GA 30136
Phone: 770-806-0220
Fax: 770-806-0120

Edson Intl
146 Duchaine Blvd
New Bedford, MA 02745
Phone: 508-995-9711
Fax: 508-995-5021

Edwards & Cromwell Mfg Inc
4301 Jeffrey Drive
Baton Rouge, LA 70816
Phone: 504-292-3377
Fax: 504-292-7519

Edwards Engineering Corp
101 Alexander Ave
Pompton Plains, NJ 07444
Phone: 201-835-2800
Natl: 800-526-5201
Fax: 201-835-3222

Eldredge Inc.
898 Fern Hill Road
Westchester, PA 19380
Phone: 610-436-4749
Fax: 610-430-6948

Electrosynthesis Co Inc
72 Ward Road
Lancaster, NY 14086-9779
Phone: 716-684-0513
Fax: 716-684-0511

Ellicott Machine Corp Intl
1611 Bush St
Baltimore, MD 21230-2093
Phone: 410-545-0220
Fax: 410-545-0293

Emergency Film Group
225 Water St
Plymouth, MA 02360
Phone: 508-746-0466
Natl: 800-842-0999
Fax: 508-746-5220

Emilcott Associates
190 Park Ave
Morristown, NJ 07960
Phone: 201-538-2700
Natl: 800-886-3645
Fax: 201-538-8221

Emilcott-dga Inc
285 N State St No. 201
Westerville, OH 43081
Phone: 614-890-0800
Natl: 800-886-3645
Fax: 614-890-0801

Enco EMC
11029 Signal Hill Drive
Austin, TX 78737
Phone: 512-288-6090
Fax: 512-288-6091

Encon Services Inc
10820 E 45th St
No. 100
Tulsa, OK 74146
Phone: 918-665-7693
Fax: 918-665-7232

Energy Efficiency Systems Inc
1300 Shames Drive
Westbury, NY 11590
Phone: 516-997-2100
Natl: 800-695-3637
Fax: 516-997-2129



Engelhard Corp
101 Wood Ave
Iselin, NJ 08830-0770
Phone: 908-205-6174
Fax: 908-205-6146

Enmet Corp
PO Box 979
Ann Arbor, MI 48106
Phone: 313-761-1270
Fax: 313-761-3220

Enpac Corp
121 Industrial Parkway
Chardon, OH 44024
Phone: 216-286-9222
Natl: 800-936-7229
Fax: 216-286-9297

Ensotech Inc
7949 Ajay Drive
Sun Valley, CA 91352
Phone: 818-767-2222
Fax: 818-768-7510

Entech Instruments Inc
2265 Ward Ave
Simi Valley, CA 93065
Phone: 805-527-5939
Natl: 800-555-8034
Fax: 805-527-5687

Entropy Inc
PO Box 12291
Research Triangle Park,
NC 27709
Phone: 919-781-3550
Natl: 800-486-3550
Fax: 919-787-8842

Envires Corp
12103 Linden Lane
Bowie, MD 20715-2350
Phone: 301-464-6260
Natl: 800-315-7770
Fax: 301-464-6264

Envirex Inc
PO Box 1604
Waukesha, WI 53187-1604
Phone: 414-547-0141
Fax: 414-547-4120

Enviro Products Inc
1431 Rensen St No. A
Lansing, MI 48910
Phone: 517-887-1222
Natl: 800-368-4764
Fax: 517-887-8374

Enviro-Assist Inc
PO Box 2155
Livingston, NJ 07039-7755
Phone: 201-922-0077
Fax: 201-922-0077

Enviro-Care Co
5614 W Grand Ave
Chicago, IL 60639
Phone: 312-745-7773
Fax: 312-745-8383

Enviro-Map Inc
2041 SW 58th Ave
Portland, OR 97221-1333
Phone: 503-297-4520
Fax: 503-297-4519

EnviroMetrics Software Inc
92 Read's Way
New Castle, DE 19720
Phone: 302-324-9136
Fax: 302-324-9138

EnviroProducts Inc
1431 Rensen St No. A
Lansing, MI 48910
Phone: 517-887-1222
Natl: 800-368-4764
Fax: 517-887-8374



EnviroQuip International Inc
8506 Beechmont Ave
Cincinnati, OH 45255
Phone: 513-388-4100
Natl: 800-543-0489
Fax: 513-388-4111

EnviroSafety Directory (No. 1423)
1635 W Alabama
Houston, TX 77006-4196
Phone: 713-529-1616
Natl: 800-654-1480
Fax: 713-523-7804

EnviroTech Pumpsystems
440 W 800 S,
PO Box 209
Salt Lake City, UT 84110-0209
Phone: 801-359-8731
Fax: 801-355-9303

Enviroair Consultants Inc
PO Box 189
Roseville, MI 48066-0189
Phone: 810-772-4230
Fax: 810-772-5705

Environetics Inc
1201 Commerce St
Lockport, IL 60441
Phone: 815-838-8331
Fax: 815-838-8336

Envirox Inc
PO Box 159
Wayne, PA 19087
Phone: 610-975-9790
Fax: 610-975-9793

Environics Inc
69 Industrial Park Road E
Tolland, CT 06084
Phone: 203-872-1111
Fax: 203-870-9333

Environmental Assessment Association
8383 E Evans Road
Scottsdale, AZ 85260
Phone: 602-483-8100
Fax: 602-998-3000

Environmental Compliance Products

Environmental Compliance Products
19800 MacArthur Blvd
No.510B
Irvine, CA 92715
Phone: 714-260-3888
Natl: 800-643-7065
Fax: 714-260-2299

Environmental Container Corp
31700 SW Riedweg Road
Cornelius, OR 97113-9609
Phone: 503-693-0774
Natl: 800-729-7137
Fax: 503-648-3136

Environmental Contracting
4190 West 123th St
Alsip, IL 60658
Natl: 800-331-1945
Fax: 708-389-4490

Environmental Data Resources Inc
3530 Post Road
Southport, CT 06490
Phone: 203-255-6606
Natl: 800-352-0050
Fax: 800-231-6802

Environmental Dynamics Inc
2870 Peachtree Road NW
No. 426
Atlanta, GA 30305
Phone: 770-642-7002
Fax: 770-552-4212

Environmental Education Enterprises E3
2764 Sawbury Blvd
Columbus, OH 43253-4580
Phone: 614-792-0005
Natl: 800-792-0006
Fax: 614-792-0006

Environmental Information Assoc, The
3805 Presidential Parkway
No. 106
Atlanta, GA 30340
Phone: 404-986-2760
Fax: 404-986-2768

Environmental Laboratory Services
7280 Caswell St
N Syracuse, NY 13212
Phone: 315-458-8033
Natl: 800-842-4667
Fax: 315-458-0249

Environmental Products & Services Inc
PO Box 315
Syracuse, NY 13209-0315
Phone: 315-471-0503
Fax: 315-475-8920

Environmental Products Inc
PO Box 900
Orville, OH 44667
Phone: 216-683-0880
Fax: 216-684-1190

Environmental Profiles Inc
8815 Centre Park Drive
No. 311
Columbia, MO 21045
Phone: 410-964-9900
Natl: 800-374-6484
Fax: 410-964-0008
Computer Software; Management; Regulatory; Consulting Services; Environmental Audit;

Environmental Site Assessment
SEE AD ON PAGE 57, 94

Environmental Recovery Resources Inc
300 Adams St
Bedford Hills, NY 10507
Phone: 914-241-2827
Fax: 914-242-7346

Environmental Resource Associates
5540 Marshall St
Arvada, CO 80002
Phone: 303-431-8454
Natl: 800-372-0122
Fax: 303-421-0159

Environmental Resource Center
101 Center Pointe Drive
Cary, NC 27513-5706
Phone: 919-469-1585
Natl: 800-537-2372
Fax: 919-469-4137

Environmental Restoration Systems
9 Dogwood Lane
Middletown, PA 17057
Phone: 717-944-5508
Natl: 800-944-5515
Fax: 717-944-4551

Environmental Risk Information & Imaging Services ERIIS
505 Huntmar Park Drive
No. 200
Herndon, VA 22070
Phone: 703-834-0600
Natl: 800-989-0402
Fax: 703-834-0606

Environmental Safety Services
1401 Paradise
Modesto, CA 95358
Phone: 209-544-6624
Fax: 209-544-6624

Environmental Science & Engineering Inc
8900 N Industrial Road
Peoria, IL 61615
Phone: 309-693-5660
Natl: 800-373-1999
Fax: 309-692-8435

Environmental Services Inc
4665 Indian School NE
No. 106
Albuquerque, NM 87110
Phone: 505-266-6611
Fax: 505-266-7738

Environmental Support Solutions
210 N Center No. 101
Mesa, AZ 85201
Phone: 602-964-5043
Natl: 800-289-6116
Fax: 602-834-4319

Environmental Systems Corp
200 Tech Center Drive
Knoxville, TN 37912
Phone: 423-688-7900
Fax: 423-687-8977

Environmental Systems Engineering Inc
23180 Del Lago
Laguna Hills, CA 92653
Phone: 714-587-1411
Fax: 714-587-9111

Environmental Tank Systems Inc (ETS)
PO Box 309
Springer, OK 73458
Phone: 405-653-2391
Natl: 800-374-8463
Fax: 405-653-2773

Environmental Technical Services Inc
4990 Grand Ave
Pittsburgh, PA 15225
Phone: 412-269-5862
Fax: 412-269-5840

Environmental Training Group Inc
10716 Little Patuxent Parkway
No. 220
Columbia, MD 21044
Phone: 410-740-1551
Natl: 800-453-4200
Fax: 410-740-1595

Environmental Waste Technology Inc
1039 Chestnut St
Newton Upper Falls, MA 02164
Phone: 617-332-2877
Fax: 617-332-8712

Environmetrics
2345 Millpark Drive
Maryland Heights, MO 63043
Phone: 314-427-0550
Natl: 800-333-3278
Fax: 314-427-7306

Enviropack
3645 NW 67th St
Miami, FL 33147
Phone: 305-693-4680
Natl: 800-327-5062
Fax: 305-836-1296

Enviroplan Inc
3 Becker Farm Road
Roseland, NJ 07068
Phone: 201-994-2300
Natl: 800-333-6494
Fax: 201-994-5100

Envirotrol Inc
432 Green St
Sewickley, PA 15143
Phone: 412-741-2030
Fax: 412-741-2670

Epcor Industrial
7745 I-40
Conroe, TX 77385
Phone: 409-273-1774
Fax: 409-273-4600

Epcor Industrial Systems Inc
PO Box 7060
The Woodlands, TX 77387
Phone: 409-273-1774
Fax: 409-273-4600

Epic Inc
654 Madison Ave
New York, NY 10021
Phone: 212-308-7038
Fax: 212-308-7266

Epoleon Corp of America
19160 S Van Ness Ave
Torrance, CA 90501
Phone: 310-782-0190
Natl: 800-376-5366
Fax: 310-782-0191

Eslon Thermoplastics
PO Box 240696
Charlotte, NC 28224
Phone: 704-889-2431
Natl: 800-578-7681
Fax: 704-889-2810

Euro Tank & Ecosafe Systems Inc
422 SW 14th St
Ocala, FL 34474
Phone: 904-629-3700
Fax: 904-629-8611

Excel
12100 I-40 E
Amarillo, TX 79101
Phone: 806-335-7737
Fax: 806-335-9017

Exploration Products 3005 N Industrial Ln Bldg 521
Spokane, WA 99216
Phone: 509-927-8101
Natl: 800-448-7312
Fax: 509-927-8559
SEE AD ON PAGE 71

Export Technologies Inc
200 Rich Lex Drive
Lexington, SC 29072
Phone: 803-794-2543
Natl: 800-762-1712
Fax: 803-796-1602

Extex Instruments
335 Bear Hill Rd
Waltham, MA 02154-1020
Phone: 617-890-7440
Fax: 617-890-7864

F

FCI Environmental Inc
1181 Grier Dr No. B
Las Vegas, NV 89119
Phone: 702-361-7921
Natl: 800-510-3627
Fax: 702-361-9652

FKC Co Ltd
2708 W 18th St
Port Angeles, WA 98363
Phone: 360-452-9472
Fax: 360-452-6880

FLI
FLI LEARNING SYSTEMS, INC.
800-354-9099

FLI Learning Systems Inc
PO Box 2233
Princeton, NJ 08543-2233
Phone: 609-466-9000
Fax: 609-466-2333

FMI Fluid Metering Inc
29 Orchard St
Oyster Bay, NY 11771
Phone: 516-922-6050
Natl: 800-223-3388
Fax: 516-624-8261

Flo Trend Systems Inc

Fabric Building Systems Inc
4919 80th Ave Circle E
Sarasota, FL 34243
Phone: 941-351-6096
Fax: 941-351-1020

Fabrico 800-621-8546

Fabrico Environmental Liners Inc
4222 S Pulaski Road
Chicago, IL 60632
Phone: 312-890-5350
Natl: 800-621-8546
Fax: 312-890-4669

Fairbanks Morse Pump Corp
3601 Fairbanks Ave
Kansas City, KS 66106
Phone: 913-371-5000
Fax: 913-371-2272

Feco Engineered Systems Ltd
5855 Grant Ave
Cleveland, OH 44105
Phone: 216-441-2400
Fax: 216-441-6529

Fibercast Co
PO Box 968
Sand Springs, OK 74063
Phone: 918-245-6651
Natl: 800-331-4406
Fax: 800-365-7473

Fiberlock Technologies Inc
630 Putnam Ave,
PO Box 390432
Cambridge, MA 02139
Phone: 617-876-8020
Natl: 800-342-3755
Fax: 617-547-6934

Fike Metal Products
704 S 10th St
Blue Springs, MO 64013
Phone: 816-229-3405
Fax: 816-228-9277

Filterspun
6125-B Ave,
PO Box 11074
Amarillo, TX 79111-0001
Phone: 806-335-2441
Natl: 800-432-0108
Fax: 806-335-3701

Finn Corp
9281 LeSaint Dr
Fairfield, OH 45014
Phone: 513-874-2818
Natl: 800-543-7166
Fax: 513-874-2914

First Fabrics Inc
4927 N Damen Ave
Chicago, IL 60625
Phone: 312-271-0336
Natl: 800-367-7760
Fax: 312-271-7210

Flair Environmental Products
4647 SW 40th Ave
Ocala, FL 34474
Phone: 904-237-1220
Fax: 904-854-1402

Flo Trend Systems Inc
707 Lehman
Houston, TX 77018
Phone: 713-699-0152
Fax: 713-699-8054
Agitators; Clarifiers,

Concentrators; Cyclones, Filtration Systems; Flotation Equipment, Inline Mixers, Mixers; Remediation Services; Separators; Sludge Concentrating Equipment; Stormwater Treatment; Wastewater Treatment Systems; Water/Wastewater Treatment Equipment; Aeration Systems; Centrifuges, Diffusers, Equipment Rental; Filter Presses; Grit Handling Equipment; Liquid Extractors; Oil/Water Separation; Screens; Sludge Dewatering Equipment
SEE AD ON PAGE 64, 91



Foxboro Co, The
 600 N Bedford St
 East Bridgewater, MA 02333
 Phone: 508-378-5556
 Natl: 800-321-0322
 Fax: 508-378-5505

Framco Environmental Technologies
 1856 Apex Road
 Sarasota, FL 34240
 Phone: 941-377-3600
 Fax: 941-377-6900



Freberg Environmental Inc
 1675 Broadway No. 2210
 Denver, CO 80202
 Natl: 800-377-4152
 Fax: 303-623-8101

Frontier Technology Inc
 609 N Eastern Ave
 Allegan, MI 49010
 Phone: 616-673-9464
 Natl: 800-307-2189
 Fax: 616-673-9629

Fybroc Div Met-Pro Corp
 700 Ermlen Way
 Telford, PA 18969
 Phone: 215-723-8155
 Fax: 215-723-2197



G O Environmental Inc
 1295 NW 163 St
 Miami, FL 33169
 Phone: 305-621-2882
 Fax: 305-621-1710

GRC Intl Inc/Flow Gemini Systems
 1900 Gallows Road
 Vienna, VA 22182
 Phone: 703-506-5166
 Natl: 800-934-5917
 Fax: 703-760-8747

GSE Lining Technology Inc
 19103 Gundle Road
 Houston, TX 77073
 Phone: 713-443-8564
 Natl: 800-435-2008
 Fax: 713-875-6010



GTS Duratek
 8955 Guilford Road
 No. 200
 Columbia, MD 21046
 Phone: 410-312-5100
 Natl: 800-338-4487
 Fax: 301-621-8211

Gardner Denver Machinery Inc
 1800 Gardner Expressway
 Quincy, IL 62301
 Phone: 217-222-5400
 Natl: 800-682-9868
 Fax: 217-224-7814



Gas Tech Inc
 8407 Central Ave
 Newark, CA 95606
 Phone: 510-745-1275
 Fax: 510-794-6201



Gator Pump Inc
 302 Corrigan
 Brownwood, TX 76801
 Phone: 915-643-3502
 Natl: 800-735-9811
 Fax: 915-643-5760

Gem Sensors Div
 1 Cowles Road
 Plainville, CT 06062
 Phone: 860-747-3000
 Natl: 800-770-0505
 Fax: 860-747-4244

Gemstone Environmental
 750 Easy St
 Simi Valley, CA 93065
 Phone: 805-527-6990
 Natl: 800-235-3375
 Fax: 805-526-7603

Gemtor Inc
 One Johnson Ave
 Matawan, NJ 07747
 Phone: 805-583-6200
 Natl: 800-405-9048
 Fax: 908-290-9391

General Carbon Corp
 33 Paterson St
 Paterson, NJ 07501
 Phone: 201-523-2223
 Fax: 201-523-1494

General Chemical Corp
 90 E Halsey Road
 Parsippany, NJ 07054
 Phone: 201-515-0900
 Natl: 800-631-8050
 Fax: 201-515-2468

General Environmental Science Corp
 29603 Hall St
 Solon, OH 44139
 Phone: 216-248-4601
 Natl: 800-544-5566
 Fax: 216-248-7175

General Equipment Co
 PO Box 334
 Owatonna, MN 55060
 Phone: 507-451-5510
 Natl: 800-533-0524
 Fax: 507-451-5511

General Kinematics Corp
 777 Lake Zurich Road
 Barrington, IL 60010
 Phone: 708-381-2240
 Fax: 708-381-1376

General Rubber/Flexible Value Corp
 11 Empire Blvd
 South Hackensack, NJ 07604
 Phone: 201-641-4700
 Natl: 800-233-6294
 Fax: 201-641-4710

General Sciences Corp
 6100 Chevy Chase Drive
 Laurel, MD 20707-2929
 Phone: 301-953-2700
 Fax: 301-953-1213

Genisys Inc.
 PO Box 14465
 Memphis, TN 38114
 Phone: 601-342-5017
 Natl: 800-646-5439
 Fax: 901-744-6093

Geo-Con
 4075 Monroeville Blvd
 No. 400
 Monroeville, PA 15146
 Phone: 412-856-7700
 Fax: 412-373-3357

GeoGuard Inc
 PO Box 149
 Medina, NY 14103
 Phone: 716-798-5597
 Natl: 800-645-7654
 Fax: 716-798-0147

GeoPure Systems & Services
 2300 Northwest 71st Place
 Gainesville, FL 32653
 Phone: 904-376-7833
 Natl: 800-342-1103
 Fax: 904-373-7660

GeoTrans Inc
 46050 Manekin Plaza
 No. 100
 Sterling, VA 20166
 Phone: 703-444-7000
 Fax: 703-444-1685

Geophysical Survey Systems Inc
 13 Klein Drive
 North Salem, NJ 03073-0097
 Phone: 603-893-1109
 Natl: 800-524-3011
 Fax: 603-889-3984

George Fischer Inc
 2882 Dow Ave
 Tustin, CA 92680-7285
 Phone: 714-731-8800
 Natl: 800-854-4909
 Fax: 714-731-6201

Georgia Steel & Chemical Co Inc
 10810 Guilford Road
 Annapolis Junction, MD 20701
 Phone: 301-317-5502
 Natl: 800-296-0351
 Fax: 301-470-6313

Geotech Environmental Equipment Inc
 1441 W 46 Ave
 No. 17
 Denver, CO 80211
 Natl: 800-833-7958
 Fax: 303-477-1230



Geraghty & Miller Inc A Heidmij Co
 1099 18th St
 No. 2100
 Denver, CO 80202
 Phone: 303-294-1200
 Fax: 303-294-1239

Gilian Instruments
 16333 Bay Vista Drive
 Clearwater, FL 34620
 Phone: 813-530-3602
 Natl: 800-451-9444
 Fax: 813-539-0550

Glas-Coi
 PO Box 2128, 711 Hulman St
 Terre Haute, IN 47802-0128
 Phone: 812-235-6167
 Natl: 800-452-7265
 Fax: 812-234-6975

Glenro Inc
 39 McBride Ave
 Paterson, NJ 07501
 Phone: 201-279-5900
 Natl: 800-922-0106
 Fax: 201-279-5900

Global Equipment Marketing Inc
 PO Box 810483
 Boca Raton, FL 33481
 Phone: 407-750-8662
 Fax: 407-750-9507

Global Technologies
 4927 N Lydell Ave
 Milwaukee, WI 53217
 Phone: 414-332-5987
 Fax: 414-332-4375



Global Water
 10752 Fair Oaks Blvd
 Fair Oaks, CA 95628
 Phone: 916-863-0804
 Fax: 916-863-0315

Goal Line Environmental
 2045 E Vernon Ave
 Los Angeles, CA 90058
 Phone: 213-233-2224
 Fax: 213-233-7428

Goad Co
 260 Old State Road
 Ellisville, MO 63021
 Phone: 314-394-6334
 Fax: 314-394-2169

Godwin Pumps of America Inc
 1 Floodgate Road
 Bridgeport, NJ 08014
 Phone: 609-467-3636
 Fax: 609-467-4741

Goodway Technologies Corp
 420 West Ave
 Stamford, CT 06902-6384
 Phone: 203-359-4708
 Natl: 800-333-7467
 Fax: 203-359-9601

Gordon & Breach Publishing
 820 Town Center Drive
 Langhorne, PA 19047
 Phone: 215-750-2642
 Natl: 800-545-8398
 Fax: 215-750-6343



Gorman-Rupp Co, The
 305 Bowman St/PO Box 1217
 Mansfield, OH 44903-1600
 Phone: 419-755-1011
 Fax: 419-755-1251
Landfills Equipment; Lift

Stations; Pump Controllers;
Pumps (sludge, wastewater,
groundwater, misc.); Water/
Wastewater Treatment
Equipment

SEE AD ON PAGE 3

Government Institutes
4 Research Place
Rockville, MD 20850
Phone: 301-921-2355
Fax: 301-921-0373

Goyen Value Corp
25327 Ave Stanford
Valencia, CA 91355
Phone: 805-257-0566
Fax: 805-257-8990

Grace Industries Inc
PO Box 167
Transfer, PA 16154
Phone: 412-962-9231
Natl: 800-969-6933
Fax: 412-962-3611

Grace Tec Systems
830 Prosper Road,
PO Box 30
DePere, WI 54115
Phone: 414-336-5715
Natl: 800-558-4447
Fax: 414-339-2784



414-259-1500

**Graef, Anhalt, Schloemer
& Associates Inc**
345 N 95th St
Milwaukee, WI 53226
Phone: 414-259-1500
Fax: 414-259-0037

Grant Environmental
12150 E Briarwood Ave
No. 200
Englewood, CO 80112
Phone: 303-790-7400
Fax: 303-799-6993

Graseby
500 Technology Court
Smyrna, GA 30082
Phone: 770-319-9999
Natl: 800-241-6898
Fax: 770-319-0336
Air Analyzers; Air Emission
Monitoring Equipment; Air
Quality Instrumentation; Air
Samplers; Analysis, Gas
Chromatography; Analytical
Instruments, Air; Cascade
Impactors; Concentrators;
Equipment Rental; Filter
Accessories; Indoor Air
Quality; Industrial Hygiene;
Monitoring Systems, Air;
Particle Sizing Instruments;
Stack Emission Monitors;
Toxic Gas Detectors

SEE AD ON PAGE 15, 89

Graseby Specac Inc
301 Commerce Drive
Fairfield, CT 06432
Phone: 203-366-5112
Natl: 800-447-2558
Fax: 203-384-1524

Grassroots Marketing Inc
84 Elmore,
PO Box 874
Croton-on-Hudson, NY 10520
Phone: 914-271-8821
Fax: 914-271-8588

Great Lakes Environmental Inc
315 S Stewart
Addison, IL 60101
Phone: 708-543-9444
Fax: 708-543-1169

Great Lakes Instruments
9020 W Dean Road
Milwaukee, WI 53224
Phone: 414-355-3601
Fax: 414-362-8346

Griffin Environmental Co Inc
7066 Interstate Island Road
Syracuse, NY 13209
Phone: 315-451-5300
Fax: 315-451-2338

Griswold Controls
2803 Barranca Parkway
Irvine, CA 92714
Phone: 714-559-6000
Natl: 800-643-8662
Fax: 714-559-6088

**Groundwater &
Environmental Services Inc**
1340 Campus Parkway,
PO Box 1750
Wall, NJ 07719
Phone: 908-919-1646
Natl: 800-220-3068
Fax: 908-919-1678

**Groundwater
Services Inc**
5252 Westchester No. 270
Houston, TX 77005
Phone: 713-663-6600
Fax: 713-663-6546

**Groundwater
Technology Inc**
100 River Ridge Drive
Norwood, MA 02062

Phone: 617-769-7600
Natl: 800-635-0053
Fax: 617-769-7992

Grundfos Pumps Corp
2555 Clovis Ave
Clovis, CA 93612
Phone: 209-292-8000
Fax: 209-291-1357

Guardian Instruments
3201 Ohio St,
PO Box 478
Michigan City, IN 46361
Phone: 219-874-5248
Fax: 219-879-6643

**Gurley Precision
Instruments**
514 Fulton St
Troy, NY 12181
Phone: 518-272-6300
Natl: 800-759-1844
Fax: 518-274-0336

H

**H H Burkitt Project
Mgmt Inc**
2041 SW 58th Ave
Portland, OR 97221-1333
Phone: 503-297-4520
Fax: 503-297-4519

**HAZMACON
The Environmental
Solutions Expo**
444 Castor St No. 1015
Mountain View, CA 94041
Phone: 415-964-2050
Fax: 415-964-2246

HDR Engineering Inc
8404 Indian Hills Drive
Omaha, NE 68114
Phone: 402-399-1000
Fax: 402-399-1238

HEMCO Corp
111 North Powell
Independence, MO 64056
Phone: 816-796-2900
Fax: 816-796-3333

HES Inc
525 Science Drive
Madison, WI 53711
Phone: 608-237-3300
Fax: 608-233-0502

**HMTRI
Hazardous Material
Handling & Research Institute**
6301 Kirkwood Blvd SW
Cedar Rapids, IA 52404
Phone: 319-398-1577
Fax: 319-398-1250

HNU Systems Inc
160 Charlemont St
Newton, MA 02161
Phone: 617-964-6690
Natl: 800-724-5600
Fax: 617-558-0056

HACH

HACH

800-227-4224

Hach Co
5600 Lindberg Drive
Loveland, CO 80537
Phone: 970-669-3050
Natl: 800-227-4224
Fax: 970-669-2932

Haley & Aldrich Inc
58 Charles St
Cambridge, MA 02141-2147
Phone: 617-494-1606
Fax: 617-577-8142

Halliday Products Inc
6401 Edgewater Drive
Orlando, FL 32810
Phone: 407-298-4470
Fax: 407-298-4534

Hancor Inc
PO Box 1047
Findlay, OH 45839
Natl: 800-242-6267
Fax: 419-424-8302

Handar
1288 Reamwood Ave
Sunnyvale, CA 94089
Phone: 408-734-9640
Natl: 800-955-7367
Fax: 408-734-0655

Hankin Environmental Systems, Inc.
908-722-9595

**Hankin Environmental
Systems Inc**
One Harvard Way No. 6
Somerville, NJ 08876
Phone: 908-722-9595
Fax: 908-722-9514

Hankson Intl
1000 Philadelphia St
Conansburg, PA 15317
Phone: 412-745-1555
Fax: 412-745-6040

Harborlite Corp
PO Box 100
Vicksburg, MI 49097
Phone: 616-649-1352
Fax: 616-649-3707

**Harding Lawson
Associates**
PO Box 578
Novato, CA 94948
Phone: 415-892-0821
Natl: 800-578-0821
Fax: 415-892-0831
SEE AD ON PAGE #

Harper & Shuman Inc
68 Moulton St
Cambridge, MA 02138-1119
Phone: 617-492-4410
Natl: 800-872-4050
Fax: 617-876-2973

Hartzell Fan Inc
910 S Downing St
Piqua, OH 45356
Phone: 513-773-7411
Natl: 800-336-3267
Fax: 513-773-8994

HARNIL CORPORATION

805-988-6800

Harwil Corp
221 Lombard
Oxnard, CA 93030
Phone: 360-260-7397

Hawk America Inc
1741 W Rose Garden Lane
Phoenix, AZ 85027
Phone: 602-943-2228
Fax: 602-516-1976

**Haws Drinking
Faucet Co**
PO Box 1999
Berkeley, CA 94701
Phone: 510-525-5801
Fax: 510-528-2812

**Haz Mat Control
Systems Inc**
5199 E Pacific Coast Hwy
No. 500
Long Beach, CA 90804-3307
Phone: 310-597-7994
Fax: 310-597-9904

HAZ-MAT CONTAINMENT CORPORATION
800-943-6510

Haz-Mat Containment Corp
712 Bancroft Road
No. 216
Walnut Creek, CA 94596
Natl: 800-943-6510
Fax: 510-210-1054

Haz-Safe Buildings
Div of CID Assoc Inc
PO Box 606
Leechburg, PA 15656
Phone: 412-842-2130
Fax: 412-845-7834
Chemical Storage Buildings;
Hazardous Waste Containers;
Enclosures; Structural;
Hazardous Waste/Mat
Treatment; Storage; Disposal;
Secondary Containment
SEE AD ON PAGE 72, 94

Haz-Stor
2454 Dempster
Des Plaines, IL 60016
Phone: 708-294-1000
Natl: 800-798-9250
Fax: 708-298-9716
Chemical Storage
Buildings; Hazardous
Material Handling;
Hazardous Waste Containers;
Hazardous Waste/Mat
Treatment, Storage; Disposal;
Secondary Containment;
Spill Control Equipment/
Products/Services
SEE AD ON PAGE 45, 114

HazWaste Technologies Corp
2995 Center Green Court S
Boulder, CO 80301
Phone: 303-440-5664
Natl: 800-492-7832
Fax: 303-440-5731

**Hazclean Environmental
Consultants Inc**
160 Upton Drive,
PO Box 16485
Jackson, MS 39236-6485
Phone: 601-922-0766
Fax: 601-922-7927

Hazco Services Inc
2006 Springboro W
Dayton, OH 45439
Phone: 513-293-2700
Natl: 800-332-0435
Fax: 513-293-9227

Hazen & Sawyer
730 Broadway
New York, NY 10003
Phone: 212-777-8400
Fax: 212-614-9049

Haztech Systems Inc
1555 Yosemite Ave No. 16
San Francisco, CA 94124
Phone: 415-822-5775
Natl: 800-453-5487
Fax: 415-822-5777

Heath Consultants Inc
9030 Monroe Road
Houston, TX 77061
Phone: 713-947-9292
Natl: 800-432-8487
Fax: 713-947-0422

Helima Cells Inc
118-21 Queens Blvd
Forest Hills, NY 11375
Phone: 718-544-9534
Fax: 718-263-6910

**Heritage Environmental
Services Inc**
7901 W Morris St
Indianapolis, IN 46231
Phone: 317-243-0811
Natl: 800-827-0476
Fax: 317-486-5085

Hersey Products
Highway 70, PO Box 128
Cleveland, NC 27013
Phone: 704-278-2221
Natl: 800-323-8584
Fax: 704-278-9616

Hertz Equipment Rental Corp
225 Brae Blvd
Park Ridge, NJ 07656
Phone: 201-307-2098
Natl: 800-223-0983
Fax: 201-307-2651

**Heyl & Patterson Inc
Renneburg Div**
PO Box 36
Pittsburgh, PA 15230
Phone: 412-788-6900
Fax: 412-788-6913

**High Plains
Consortium Inc**
1720 Burnt Boat Drive,
PO Box 1292
Bismarck, ND 58501
Phone: 701-255-6080
Fax: 701-250-9177

**Highland Tank &
Manufacturing Co**
One Highland Road
Stoytown, PA 15563
Phone: 814-893-5701
Fax: 814-893-6126

Hoechst Celanese Corp
PO Box 5650
Spartanburg, SC 29304
Natl: 800-845-7597
Fax: 803-579-5930

Holophane Corp
250 E Broad St No. 1400
Columbus, OH 43215
Phone: 614-345-9631
Fax: 614-349-4426

**Holzmaier McLendon
& Murrell PC**
575 Broad Hollow Road
Melville, NY 11747
Phone: 516-756-8000
Fax: 516-694-4122

Horiba Instruments Inc
17671 Armstrong Ave
Irvine, CA 92714
Phone: 714-250-4811
Natl: 800-446-7422
Fax: 714-250-0924

**Horizontal
Technologies Inc**
2309 Hancock Bridge Parkway
Cape Coral, FL 33990
Phone: 941-995-8777
Natl: 800-940-1128
Fax: 941-995-8465

**Horsehead Resource
Development Co Inc**
Fourth & Delaware St
Palmerton, PA 18071
Natl: 800-253-5579
Fax: 610-826-8993

Hubbell Roth & Clark Inc
PO Box 824
Bloomfield Hills, MI 48303-0824
Phone: 810-338-9241
Fax: 810-338-2592

Hudson Industries
PO Box 2212
Hudson, OH 44236
Phone: 216-487-0668
Natl: 800-487-9668
Fax: 216-487-0811

Hungerford & Terry Inc
226 Atlantic Ave
Clayton, NJ 08312
Phone: 609-882-3200
Fax: 609-881-6859

Hycor Corp
29850 N Highway 41
Lake Bluff, IL 60044
Phone: 708-473-3700
Fax: 708-473-0477

Hyde Products
28045 Ranney Parkway
Cleveland, OH 44145
Phone: 216-871-4885
Natl: 800-999-0009
Fax: 216-871-1143

Hydro Group Inc
1011 Route 22
Bridgewater, NJ 08807
Phone: 908-704-8880
Natl: 800-718-9777
Fax: 908-704-9522

Hydro-Terra Inc
9192 Red Branch Road
No. 290
Columbia, MD 21045
Phone: 410-995-1246



HydroCal
22732 Granite Way Unit A
Laguna Hills, CA 92653
Phone: 714-455-0765
Fax: 714-455-0764

HydroGeoLogic Inc
1165 Herndon Parkway
No. 900
Herndon, VA 22070
Phone: 703-478-5186
Fax: 703-471-4180

Hydrolab Corp
PO Box 50116
Austin, TX 78763
Phone: 512-255-8841
Natl: 800-949-3766
Fax: 512-255-3106
**Conductivity Instrumentation;
Dissolved Oxygen
Detectors; Dissolved
Solids Detectors; Level
Instrumentation;
Monitoring Systems,
Water; ORP Instrumentation;
pH Instrumentation;
Sensors; Temperature
Instrumentation; Turbidity
Instrumentation; Water
Quality Instrumentation**
SEE AD ON PAGE 40, 118

**Hygeia Environmental
Laboratories Inc**
82 W Sierra Madre Blvd
Sierra Madre, CA 91024-4497
Phone: 818-355-4711
Fax: 818-355-4497

ICF Kaiser International Inc
9300 Lee Highway
Fairfax, VA 22031-1207
Phone: 703-934-3600
Fax: 703-934-9740

IHS Logistics Library
15 Inverness Way E
Englewood, CO 80112
Phone: 303-267-1517
Natl: 800-320-5660
Fax: 303-486-1710

**IHS Regulatory
Products - EarthLaw**
15 Inverness Way E
Englewood, CO 80112
Phone: 303-267-1517
Natl: 800-525-7052
Fax: 303-267-1360

ILC Dover Inc
6867 Carpenter Bridge Road
Frederica, DE 19946
Phone: 302-335-3911
Natl: 800-631-9567
Fax: 302-335-0762



**IMS Inc (Innovative
Material Systems Inc)**
15705 S 169 Highway
Olathe, KS 66062-3503
Phone: 913-829-2900
Natl: 800-800-4010
Fax: 913-829-2989

**ISTA Energy
Systems Corp**
415 Hope Ave
Roselle, NJ 07203
Phone: 908-241-8880
Fax: 908-241-7288

ITT A-C Pump/ITT Marlow
1150 Tennessee Ave
Cincinnati, OH 45229
Phone: 513-482-2500
Fax: 513-482-2569

Ibex Technologies
550 Main St No. G
Placerville, CA 95667
Phone: 916-939-8888
Fax: 916-621-2007

**Idetek Inc/Quantix
Environmental**
1245 Reamwood Ave
Sunnyvale, CA 94089
Phone: 408-745-0544
Natl: 800-322-5487
Fax: 408-745-0473

In-Situ Inc
210 S Third St,
PO Box 1
Laramie, WY 82070
Phone: 307-742-8213
Natl: 800-446-7488
Fax: 307-721-7598
**Aquifer Restoration, Deep
Well Systems Groundwater
Testing & Monitoring
Equipment; Stormwater
Monitoring; Data Loggers;
Level Instrumentation;
Monitoring Systems, Water;
Rental Services; Water
Quality Instrumentation**
SEE AD ON PAGE 31

InVitro Intl
16632 Millikan Ave
Irvine, CA 92714
Natl: 800-246-2487
Fax: 714-851-0563
SEE AD ON PAGE 163

**Inchape Testing
Services/Environmental
Laboratories**
1 Tech Drive
Andover, MA 01810
Phone: 508-689-7954
Natl: 800-978-8378
Fax: 508-689-9433

**Industrial Filter
& Pump Mfg Co**
5900 Ogden Ave
Cicero, IL 60650-3888
Phone: 708-656-7800
Fax: 708-656-7806

Industrial Glassware
130 Bogden Blvd
Millville, NJ 08332
Phone: 609-327-2688
Fax: 609-327-0750

Industrial Scientific Corp
1001 Oakdale Road
Oakdale, PA 15071
Phone: 412-788-4353
Natl: 800-338-3287
Fax: 412-488-8353

Inficon Inc
2 Technology Place
E Syracuse, NY 13057-9714
Phone: 315-434-1100
Fax: 315-437-3803
**Analytical Instruments; Air;
Hydrocarbon Detectors; Leak
Detectors; Pressure/Vacuum
Instrumentation; Process
Control Instrumentation;
Stack Emission Monitors**

Infiltrator Systems Inc
4 Business Park Road,
PO Box 768
Old Saybrook, CT 06475
Phone: 203-388-6639
Natl: 800-221-4436
Fax: 203-388-6810

**Innovative Concepts
Program**
PO Box 999 K8-11
Richland, WA 99352
Phone: 509-372-4328
Fax: 509-372-4369

Innovative Sensors Inc
4745 E Bryson St
Anaheim, CA 92807
Phone: 714-779-8781
Natl: 800-835-5474
Fax: 717-779-9315

Inorganic Ventures Inc
195 Lehigh Ave No. 4
Lakewood, NJ 08701
Phone: 908-901-1900
Natl: 800-669-6799
Fax: 908-901-1903

Insitex Inc
2110 Omega Road No. D
San Ramon, CA 94583
Phone: 510-837-1330
Natl: 800-995-9902
Fax: 510-537-3864



Insituform Technologies Inc
1770 Kirby Parkway
No. 300
Memphis, TN 38138
Phone: 901-759-7473
Natl: 800-234-2992
Fax: 901-759-7500

Instrumark International Inc
543 Sinclair Frontage Road
Milpitas, CA 95035-5414
Phone: 408-262-0717
Fax: 408-262-3610

**Instrumentation
Northwest Inc (INW)**
14972 NE 31st Circle
Redmond, WA 98052
Phone: 206-885-3729
Natl: 800-776-8355
Fax: 206-867-0404

Instruments Direct Inc
3535 SW Corp Parkway
Palm City, FL 34990
Phone: 407-287-3355
Fax: 407-286-0015

Intec Controls
55 West St
Walpole, MA 02081
Phone: 508-660-1221
Fax: 508-660-2374

**Integrated Environmental
Solutions Inc**
3787 Old Middleburg Rd No. 3
Jacksonville, FL 32210
Phone: 904-778-1188
Fax: 904-778-0201
**Air Strippers; Aquifer
Restoration Bioremediation;
Consulting Services;
Contracting Services;
Groundwater Reclamation;
Groundwater
Treatment/Services;
Hazardous Waste Services;
Operation & Maintenance
Services; Remediation; In-
Situ Remediation Services;
Soil Gas/Groundwater
Surveys; Vapor Recovery;
VOC Removal Systems**
SEE AD ON PAGE 35, 87

Intek Corp/Rent-Alyzer
10410 Rockley Road
Houston, TX 77099
Phone: 713-498-5855
Natl: 800-323-6527
Fax: 713-498-2134

InterNet Inc
2730 Nevada Ave N
Minneapolis, MN 55427
Phone: 612-541-9690
Natl: 800-328-8456
Fax: 612-541-9692

Intergraph
Mailstop LR 24 B
No. 3
Huntsville, AL 35894
Phone: 205-730-8652
Fax: 205-730-8225

Interlab Inc
PO Box 422
Blandon, PA 19510
Phone: 610-987-9595
Fax: 610-987-9593

**International Protective
Coatings Corp**
725 Carol Ave
Oakhurst, NJ 08502
Phone: 908-531-3667
Natl: 800-334-8796
Fax: 908-531-5192

**International Reserve
Equipment Corp**
4 S Prospect Ave,
PO Box 198
Clarendon Hills, IL 60514-0198
Phone: 708-325-7040
Fax: 708-325-7045

**International Safety
Instruments**
922 Hurricane Shoals Road
Lawrenceville, GA 30043
Phone: 770-962-2552
Natl: 800-235-7677
Fax: 770-963-2797

International Sensor Technology

International Sensor Technology
3 Whatney
Irvine, CA 92718
Phone: 714-452-9000
Fax: 714-452-9009

Interscan Corp
PO Box 2496
Chatsworth, CA 91313-2496
Phone: 818-882-2331
Natl: 800-458-6153
Fax: 818-341-0642

Intervac
7100 Second St NW
Albuquerque, NM 87109

Intralox Inc
201 Laitram Lane
Harahan, LA 70123
Phone: 504-733-0463
Natl: 800-535-8848
Fax: 504-734-0063

Invalco Inc
401 S Adams
Hutchinson, KS 67501
Phone: 316-665-6612
Natl: 800-468-2626
Fax: 316-669-2242

Ionics Inc
65 Grove St
Watertown, MA 02172
Phone: 617-926-2500
Natl: 800-446-6427
Fax: 617-926-4304

Iso Inc Environmental Div
531 Westgate Blvd
Lincoln, NE 68528
Phone: 402-474-2233
Natl: 800-228-4373
Fax: 402-474-6685

J

J&H Machine Co., Inc. 215-947-0930

J & H Machine Co Inc
159A Tomlinson Road
Huntingdon Valley, PA 19006
Phone: 215-947-0930
Fax: 215-947-1316

J J Keller & Associates
3003 W Breezewood Lane
Neanah, WI 54957-0368
Phone: 414-722-2848
Natl: 800-558-5011
Fax: 414-727-7526

J L Rochester Co
65 Hillhurst Lane
Rochester, NY 14617
Phone: 716-467-7816
Fax: 719-467-6853

JBI Spray Booths & Finishing Systems
801 Norway Road
Osseo, WI 54758
Phone: 715-597-3168
Natl: 800-848-8738
Fax: 715-597-2193

JM Clipper Corp
PO Drawer 2340
Nacogdoches, TX 75963
Natl: 800-233-3900
Fax: 409-560-8998

JPS Elastomers Corp
9 Sullivan Road
Holyoke, MA 01040-2800
Phone: 413-533-8100
Natl: 800-621-2281
Fax: 413-552-1198

JT Baker Div of Mallinckrodt Baker Inc
222 Red School Lane
Phillipsburg, NJ 08865
Phone: 908-859-2151
Natl: 800-582-2537
Fax: 908-859-9318

JWC Environmental
290 Paularino Ave
Costa Mesa, CA 92626
Phone: 714-833-3888
Natl: 800-331-2277
Fax: 714-833-8858

JWI
2155 112th Ave
Holland, MI 49424
Phone: 616-772-9011
Natl: 800-245-3006
Fax: 616-772-4516

Jaca Corp
550 Pinetown Road
Fort Washington, PA 19034
Phone: 215-643-5466
Natl: 800-292-2510
Fax: 215-643-2772

Jaeger Products Inc
1611 Peachleaf
Houston, TX 77039
Phone: 713-449-9500
Natl: 800-678-0345
Fax: 713-449-9400

Jeffrey/Indresco
PO Box 387
Woodruff, SC 29388
Phone: 803-476-7523
Fax: 803-476-7510

Jerman, Daniel L, Co
275 Railroad Place
Hackensack, NJ 07601
Natl: 800-654-3733
Fax: 201-487-3953

John Crane Intl
6400 W Oakton St
Morton Grove, IL 60053
Phone: 708-967-2400
Natl: 800-732-5464
Fax: 708-967-3915

**John Zink Co
Div Koch Engineering Co**
11920 E Apache
Tulsa, OK 74116
Phone: 918-234-1800
Fax: 918-234-2700

Johnson & Associates Consulting
9131 Benwick
Spring, TX 77379
Phone: 713-379-5818
Fax: 713-379-5818

Johnson Matthey
460 E Swedesford Road
Wayne, PA 19087-1880
Phone: 610-971-3100
Fax: 610-293-1284

Johnson Yokogawa Corp
4 Dart Road
Newman, GA 30265
Phone: 770-254-0400
Fax: 770-251-0029

Jordan Systems
119 3rd St NE
No. 307
Cedar Rapids, IA 52401
Phone: 319-364-0036
Natl: 800-589-3023
Fax: 319-364-6540

Joseph Marketing Inc
203 Tilden Drive
E Syracuse, NY 13057
Phone: 315-437-0217
Fax: 315-437-0487

Justrite Manufacturing
2454 Dempster St
Des Plaines, IL 60016
Phone: 847-298-9250
Fax: 847-298-9250

Justrite Manufacturing Co LLC
2454 Dempster
Des Plaines, IL 60016
Phone: 708-298-8250
Natl: 800-798-9250
Fax: 708-298-3429

K

K & B Design Inc
3131 Disney St
Cincinnati, OH 45209
Phone: 513-351-6200
Fax: 513-351-4071

K P S I
503 Vista Bella No.11
Oceanside, CA 92057
Phone: 919-997-6066
Natl: 800-328-3665
Fax: 919-997-0563

K-F Environmental Technologies Inc
210 West Parkway Unit,
PO Box 277
Pompton Plains, NJ 07444
Phone: 201-616-0700
Fax: 201-616-9504

K-Tron America
Routes 55 and 553
Pitman, NJ 08071
Phone: 609-589-0500
Fax: 609-589-8113

KVA/Analect
9420 Jeronimo
Irvine, CA 92718
Phone: 714-587-2300
Fax: 714-855-2538

Kann Manufacturing Inc
210 Regent St,
Box 400
Guttenberg, IA 52052
Phone: 319-252-2035
Fax: 319-252-3069

Katec Inc
PO Box 3399,
1728 Va Beach Blvd
No. 105
Virginia Beach, VA 23454
Natl: 800-843-5257
Fax: 804-428-5757

Kay Industries Inc
604 N Hill St
South Bend, IN 46617
Phone: 219-236-6220
Natl: 800-348-5257
Fax: 219-289-5932

Keating Environmental Management Inc
7 Great Valley Parkway
Malvern, PA 19355
Phone: 610-296-3800
Fax: 610-251-2165

Keck Instruments Inc
1099 W Grand River Ave.,
PO Box 345
Williamston, MI 48895
Phone: 517-655-5616
Natl: 800-542-5681
Fax: 517-655-1157

Keithley Metrayte
440 Myles Standish Blvd
Taunton, MA 02780
Phone: 508-880-3000
Fax: 508-880-0179

Kemper Risk Management Services
1 Kemper Drive
Long Grove, IL 60049-0075
Phone: 708-320-2400
Natl: 800-323-9585
Fax: 708-320-4330

Kewaunee Scientific Corp
PO Box 1842
Statesville, NC 28677
Phone: 704-873-7202
Fax: 800-932-3296

Keystone Filter Div Met-Pro Corp
2385 N Penn Road
Hatfield, PA 19440
Phone: 215-822-1963
Natl: 800-822-1963
Fax: 215-997-1839

Killam Associates
27 Bleeker St
Millburn, NJ 07041
Phone: 201-379-3400
Natl: 800-832-3272
Fax: 201-376-1072

KIN-TEK
Good Analysis Depends On Good Calibration
800-326-3627

Kin-Tek
504 Laurel
La Marque, TX 77591
Phone: 409-938-3627
Natl: 800-326-3627
Fax: 409-938-3710

Kinetico Inc Engineered Systems Div
10845 Kinsman Road
Newbury, OH 44065
Phone: 216-564-5397
Natl: 800-633-5530
Fax: 216-338-8694

Kipp & Zonen
390 Central Ave
Bohemia, NY 11716
Phone: 516-589-2885
Natl: 800-645-1025
Fax: 516-589-2068

Kistele-Morse
19021 120th Ave NE
Bothell, WA 98011-9511
Phone: 206-486-6600
Natl: 800-426-9010
Fax: 206-402-1500

Lab-Line Instruments Inc

Knorr Associates
10 Park Place,
PO Box 218
Butler, NJ 07405
Phone: 201-342-8500
Fax: 201-492-0453

Kraissl Co Inc
299 Williams Ave
Hackensack, NJ 07601-5225
Phone: 201-342-0008
Fax: 201-342-0025

Krebs Engineers Inc
1205 Chrysler Drive
Menlo Park, CA 94025
Phone: 415-325-0751
Fax: 415-326-7048

Kruck Environmental Services Inc
2455 SW Fourth Ave
Ontario, OR 97914
Phone: 503-889-9684
Natl: 800-782-9684
Fax: 503-889-9684

L

L & L Process Industries Inc
303 Wyoming Ave,
PO Box 195
Wyoming, PA 18644-0195
Phone: 717-693-1661
Fax: 717-693-1666

L I P Strippers
14 Wadsworth Place
Smithtown, NY 11787
Phone: 516-265-7306
Fax: 516-360-2264

L J Broutman & Assoc Ltd
3424 S State Road
Chicago, IL 60616
Phone: 312-842-4100
Fax: 312-842-3583

LCI Laser Compass Instruments Inc
5654 Kilmore Crescent E
Surrey, British Columbia,
Canada, CN V3S 6G1
Phone: 604-574-1067
Natl: 800-565-1737
Fax: 604-574-1663

LWD Inc
PO Box 327
Calvert City, KY 42029
Phone: 502-395-8313
Fax: 502-395-8153

La-Man Corp
PO Box 487,
7450 S Homestead Drive
Hamilton, IN 46742
Phone: 219-488-3511
Natl: 800-348-2463
Fax: 219-488-3409

LaBounty Manufacturing
100 State Road 2
Tow Harbors, MN 55616-8015
Phone: 218-834-2123
Fax: 218-834-3879

Lab-Line Instruments Inc
15th & Bloomingdale Ave
Melrose Park, IL 60160
Phone: 708-450-2600
Natl: 800-525-2463
Fax: 708-450-0943

LabChem Inc
200 William Pitt Way
Pittsburgh, PA 15238
Phone: 412-826-5230
Fax: 412-826-5234

Labconco Corp
8811 Prospect Ave
Kansas City, MO 64132-2696
Phone: 816-333-8811
Natl: 800-821-5525
Fax: 816-363-0130

Laidlaw Environmental Services
PO Box 21079
Columbia, SC 29221
Phone: 803-551-4291
Fax: 803-551-4346

Lakeside Equipment Corp
1022 E Devon Ave,
PO Box 8448
Bartlett, IL 60103
Phone: 708-837-5640
Fax: 708-837-5640

Lakewood Instruments An Osmonics Co
4857 W Van Buren
Phoenix, AZ 85047
Phone: 602-272-5100
Natl: 800-228-0839
Fax: 602-272-0400

Lamson Corp
1 Lamson St,
PO Box 4857
Syracuse, NY 13221
Phone: 315-433-5500
Natl: 800-543-7736
Fax: 315-433-5451

Land Combustion
2525-B Pearl Buck Road
Bristol, PA 19007
Phone: 215-781-0810
Natl: 800-922-9679
Fax: 215-781-0798

Landa Water Cleaning Systems
13705 NE Airport Way
Portland, OR 97230
Phone: 503-255-5980
Natl: 800-645-2632
Fax: 800-535-9164

Landtec Products Inc
5308 Derry Ave Unit F
Agoura Hills, CA 91301
Phone: 818-707-2285
Fax: 818-707-9367

Lapeyre Stair Inc
PO Box 50699
New Orleans, LA 70150
Phone: 504-733-6009
Natl: 800-535-7631
Fax: 504-733-4393

Larox Inc
9730 Patuxent Woods Drive
Columbia, MD 21046
Phone: 410-381-3314
Fax: 410-381-4490

Leeman Labs Inc
55 Technology Drive
Lowell, MA 01851
Phone: 508-454-4442
Fax: 508-452-7429

Legi-Slate
777 N Capital St
Washington, DC 20002
Phone: 202-898-2300
SEE AD ON PAGE 10, 113

Lexicon Environmental Associates Inc
790 E Market St No. 270
West Chester, PA 19382-4806
Phone: 610-344-3380
Fax: 610-344-3388

Licata Energy & Environmental Consultants Inc
345 Concord Road
Yonkers, NY 10710-1824
Phone: 914-779-3451
Fax: 914-779-4234

Limitorque
PO Box 11318,
5714 Woodall Road
Lynchburg, VA 24056
Phone: 804-528-4400
Fax: 804-522-9858

Lindberg
304 Hart St
Watertown, WI 53094
Phone: 414-262-3916
Natl: 800-873-4468
Fax: 414-262-3995



Liquid Waste Technology
422 Main St, PO Box 250
Somerset, WI 54025
Phone: 715-247-5464
Natl: 800-243-1406
Fax: 715-247-3934
SEE AD ON PAGE 65

Little Giant Pump Co
3810 N Tulsa St
Oklahoma City, OK 73112
Phone: 405-947-2511
Fax: 405-947-8720

Lockwood Greene Technologies Inc
1201 Oakridge Turnpike
No. 101
Oakridge, TN 37830
Phone: 423-241-4000
Fax: 423-241-4010

Loeinger Mfg Inc
PO Box 870
Casselton, ND 58012
Phone: 701-347-5441
Natl: 800-373-5441
Fax: 701-347-4323

Logic Beach Inc
8363-6F Center Drive
La Mesa, CA 91942
Phone: 619-698-3300
Fax: 619-469-8604

Logical Technology Inc
5113 N Executive Drive
Peoria, IL 61614
Phone: 309-689-2900
Natl: 800-266-7591
Fax: 309-689-2911
Computer Databases;
Computer Modeling (Air,
Groundwater, Hazard & Risk);
Computer Software,
Management; Computer
Software, Regulatory
SEE AD ON PAGE 49, 94

Luft Instruments Inc
3 Hillside Road,
PO Box 214
Lincoln, MA 01773
Phone: 617-259-9215
Fax: 617-259-9215

Lumidor Safety Products
11221 Interchange Circle S
Miramar, FL 33025
Phone: 305-433-7000
Phone: 305-433-7220
Natl: 800-433-7220
Fax: 305-433-7730

Lundahl Instruments Inc
429 S Main
Logan, UT 84321
Phone: 801-753-7300
Natl: 801-753-7490

Lutz Pumps Inc
1160 Beaver Ruin Road
Norcross, GA 30093
Phone: 770-925-1222
Natl: 800-843-3901
Fax: 770-923-0334



M L E
870 97th Ave N
Naples, FL 33963
Phone: 941-597-5566
Fax: 941-597-4060

M-D Pneumatics Div Tutthill Corp
4840 W Kearney St
Springfield, MO 65803
Phone: 417-865-8715
Fax: 417-865-2950

MEC Co
1400 N Main St,
PO Box 330
Neodesha, KS 66757
Phone: 316-325-2673
Fax: 316-325-2678

MKS Instruments Inc
6 Shattuck Road
Andover, MA 01810
Phone: 508-975-2350
Natl: 800-227-8766
Fax: 508-975-0093

MMC International Corp
60 Inip Drive
Inwood, NY 11096
Phone: 516-239-7339
Natl: 800-645-7339
Fax: 516-371-3134
SEE AD ON PAGE #

MMT Environmental Services Inc
4610 N Churchill St
St Paul, MN 55126
Phone: 612-483-9595
Phone: 612-483-2699

MPC Containment Systems Ltd
4834 S Oakley
Chicago, IL 60609
Phone: 312-927-4120
Natl: 800-621-0146
Fax: 312-650-6028



MSI/Mechanical Systems Inc
480 Progress Way
Sun Prairie, WI 53590
Phone: 608-825-8055
Fax: 608-825-2295

Mabbett & Associates Inc
5 Alfred Circle
Bedford, MA 01730-2346
Phone: 617-275-6050
Natl: 800-877-6050
Fax: 617-275-5651

Mac Environmental
10741 NW Ambassador Drive
Kansas City, MO 64153
Phone: 816-891-9300
Natl: 800-821-2476
Fax: 816-891-8978

Magellan Systems Corp
960 Overland Ct
San Dimas, CA 91773
Phone: 909-394-5000
Fax: 909-394-7050

Magid Glove & Safety Mfg Co
2060 N Kolmar Ave
Chicago, IL 60639
Phone: 312-384-2070
Natl: 800-444-8010
Fax: 312-384-6677

Manning Environmental Inc
401 W Eighth St
Georgetown, TX 78626
Phone: 512-863-9337
Natl: 800-863-9337
Fax: 512-863-4472

Marathon Equipment Co
PO Box 1798
Vernon, AL 35592
Phone: 205-695-8517
Natl: 800-633-8974
Fax: 205-695-8813

Marine & Environmental Testing Inc
4115 N Mississippi Ave,
PO Box 5693
Portland, OR 97228-5693
Phone: 503-282-6920
Fax: 503-282-6929

Marine Shale Processors Inc
9828 US Highway 90 E
Morgan City, LA 70380
Phone: 504-631-3161
Natl: 800-872-6774
Fax: 504-631-6292

Marking Services Inc
PO Box 92219
Milwaukee, WI 53202
Phone: 414-271-2022
Natl: 800-234-0135
Fax: 414-271-7671

Mars Co
3940 SE 45th Court
Ocala, FL 34471
Phone: 904-694-7195
Natl: 800-782-5268
Fax: 904-694-7397

Marsh-McBirney Inc
4539 Metropolitan Court
Frederick, MD 21704
Phone: 301-874-5599
Natl: 800-368-2723
Fax: 301-874-2172

Martin Goffman Associates
3 Dellview Drive
Edison, NJ 08820-2545
Phone: 908-549-5433



Martin Marietta Magnesia Specialties Inc
2323 Eastern Blvd
Bldg E
Baltimore, MD 21220-0470
Phone: 410-780-5500
Natl: 800-648-7400
Fax: 410-780-5777

Mast/Keystone Inc
4673 Aircenter Circle
Reno, NV 89502
Phone: 702-827-8110
Natl: 800-806-6569
Fax: 702-827-8263

Maxymilian Technologies Inc
1801 East St
Pittsfield, MA 01201
Phone: 413-499-3050
Natl: 800-695-7771
Fax: 413-443-0511

Mazzei Injector Corp
500 Rossiter Drive
Bakersfield, CA 93307
Phone: 805-363-6500
Fax: 805-363-6700

McCaffery & Ratner Inc
370 Lexington Ave
New York, NY 10017
Phone: 212-661-8940
Fax: 212-490-1923

McNeill Intl
7041 Hodgson Road
Mentor, OH 44060
Phone: 216-953-0005
Natl: 800-626-3455
Fax: 216-953-1933

McTighe Industries Inc
2100 N Kimball St
Mitchell, SD 57301-0928
Phone: 605-996-1162
Fax: 605-996-1908

Medical Coaches Inc
PO Box 129,
Hemlock Road
Oneonta, NY 13820
Phone: 607-432-1333
Fax: 607-432-8190

Medina Agriculture Products Co Inc
PO Box 309
Hondo, TX 78861
Phone: 210-426-3011
Fax: 210-426-2288

Meflag Div Met-Pro Corp
160 Cassell Road
Harleysville, PA 19438
Phone: 215-721-6030
Fax: 215-723-6758

Megator Corp

Megator Corp
562 Alpha Drive
Pittsburgh, PA 15238
Phone: 412-963-9200
Natl: 800-245-6211
Fax: 412-963-9214

Membrane Technology & Research Inc
1360 Willow Road
Menlo Park, CA 94025
Phone: 415-328-2228
Fax: 415-328-6580

Meriter
1790 Potrero Drive
San Jose, CA 95124
Phone: 408-265-6482
Fax: 408-265-6082

Met One Instruments Inc
1600 Washington Blvd
Grants Pass, OR 97526
Phone: 541-471-7111
Fax: 541-471-7116

Air Emission Monitoring Equipment; Calibration; Communication Equipment; Data Acquisition Equipment; Evaporation Equipment; Instrument Accessories; Instrument Rental; Monitoring Systems, Air; Recorder Accessories; Recorders; Temperature Instrumentation; Training Services/Equipment; Air Quality Instrumentation; Data Loggers; Meteorological; Sensors; Shelters
SEE AD ON PAGE 43, 85

Met-Pro Corp Systems Div
160 Cassell Road
Harleysville, PA 19438
Phone: 215-723-6751
Fax: 215-723-6161

Metcalf & Eddy
Route 22 West
Branchburg, NJ 08876
Phone: 908-685-4555
Fax: 908-685-4666

Metco Environmental
PO Box 598
Addison, TX 75001
Phone: 214-931-7127
Natl: 800-394-1194
Fax: 214-931-8398



Metritape Inc
59 Porter Road
Littleton, MA 01460-1431
Phone: 508-486-9800
Fax: 508-486-0170

Metrosonics Inc
PO Box 23075
Rochester, NY 14692
Phone: 716-334-7300
Fax: 716-334-2635



Metrotech Corp
488 Tasman Drive
Sunnyvale, CA 94089
Phone: 408-734-1400
Fax: 408-734-1415

Mettler-Toledo Process Analytical Inc
261 Ballardvale St
Wilmington, MA 01887
Phone: 508-658-7615
Natl: 800-352-8763
Fax: 508-658-6973

Meyer & Sons Inc, Wm W
8261 Elmwood Ave.
PO Box 105
Skokie, IL 60077
Phone: 708-673-0312
Fax: 708-673-5564

Micro Air Air Cleaners by Metal-Fab Inc
PO Box 1138
Wichita, KS 67201
Phone: 316-943-2351
Natl: 800-835-2830
Fax: 316-943-2717

Micro Analytical Laboratories Inc
3618 NW 97th Blvd
Gainesville, FL 32606
Phone: 352-332-1701
Natl: 800-358-3160
Fax: 352-332-3572

Microbics Corp
2232 Rutherford Road
Carlsbad, CA 92008-8883
Phone: 619-438-8282
Natl: 800-642-7629
Fax: 619-438-2980

Microphor Inc
452 E Hill Road,
PO Box 1460
Willits, CA 95490
Phone: 707-459-5563
Natl: 800-358-8280
Fax: 707-459-6617

Mid-States Recycling Systems Inc
9710 Industrial Drive
Bridgeview, IL 60455
Phone: 708-430-3888
Natl: 800-235-8351
Fax: 708-430-5331

Mid-West Instrument
6500 Dobry Drive
Sterling Heights, MI 48314
Phone: 810-254-6500
Natl: 800-648-5778
Fax: 810-254-6509

Mid-Western Processes Inc
32043 Howard
Madison Heights, MI 48071
Phone: 810-588-6500
Fax: 810-585-8636

Midwest Laboratories Inc
13611 B St
Omaha, NE 68144-3693
Phone: 402-334-7770
Fax: 402-334-9121

Mil-Ram Technology Inc
647 Tully Road No. 5
San Jose, CA 95111
Phone: 408-293-5085
Fax: 408-293-5086

Milco Safety Rental
9033 Monroe Road
Houston, TX 77061
Phone: 713-947-1738

Millennium Science & Engineering Inc
1364 Beverly Road No. 301
McLean, VA 22101
Phone: 703-734-1099
Fax: 703-734-1933

Millipore Corp
80 Ashby Road
Bedford, MA 01730
Natl: 800-645-5476
Fax: 617-275-5550

Milltronics Inc
709 Stadium Drive
Arlington, TX 76011
Phone: 817-277-3543
Fax: 817-277-3894



Misonix Inc
1938 New Highway
Farmingdale, NY 11735
Phone: 516-694-9555
Natl: 800-645-9846
Fax: 516-694-9412

Mitsui Machinery Distribution Inc
PO Box 429
Bridgeport, NJ 08014
Phone: 609-467-3080
Natl: 800-433-1382
Fax: 609-467-5235

Mobile Medical Testing Service Inc
71 W Dudleytown Road
Bloomfield, CT 06002
Natl: 800-233-5401
Fax: 860-242-3104

Mobile Process Technology
2070 Airways Blvd
Memphis, TN 38114
Phone: 901-744-1142
Natl: 800-238-3028
Fax: 901-743-2361
SEE AD ON PAGE 46, 127

Modutec Inc
920 Candai Road
Manchester, NH 03109
Phone: 603-669-5121
Fax: 603-662-2690

Moldex-Metric Inc
10111 W Jefferson Ave
Culver City, CA 90232
Phone: 310-837-6500
Natl: 800-421-0668
Fax: 310-837-9563

Monarch Instrument
15 Columbia Avenue
Amherst, NH 03031-2334
Phone: 603-883-3390
Natl: 800-999-3390
Fax: 603-886-3300

Monarch Separators Inc
5410 Trafalgar Drive
Houston, TX 77045
Phone: 713-433-7441
Fax: 713-433-9105

Monitek Technologies Inc
1495 Zephyr Ave
Hayward, CA 94544
Phone: 510-471-8300
Natl: 800-458-4454
Fax: 510-471-8647

Monitor Labs Inc
74 Inverness Drive E
Englewood, CO 80112-5189
Phone: 303-792-3300
Natl: 800-422-1499
Fax: 303-799-4853



Monsanto Enviro-Chem Systems Inc
14522 S Outer Forty Road
St. Louis, MO 63017
Phone: 314-275-5700
Fax: 314-275-5701

Moore Enviro-Chemical
241 Lombard St No. 5
Thousand Oaks, CA 91360
Phone: 805-381-0733
Fax: 805-446-6409



Morehouse-Cowles Inc
1600 W Commonwealth Ave
Fullerton, CA 92633
Phone: 714-738-5000
Fax: 714-738-5960



Morrison Knudsen Corp
720 Park Blvd,
PO Box 73,
Boise, ID 83729
Phone: 208-386-7150
Fax: 208-386-5658



Morton International
100 N Riverside Plaza
Chicago, IL 60606
Phone: 312-807-2345
Fax: 312-807-3460



Mount Sopris Instrument Co
17301 W Colfax No. 255
Golden, CO 80401
Phone: 303-279-3211
Fax: 303-279-2730

Moyno Industrial Products Unit of Robbins & Myers Inc
1960 W Jefferson St
Springfield, OH 45501
Phone: 513-327-3397
Fax: 513-327-3194

Multitek Inc
PO Box 170, 700 Main St
Prentice, WI 54556-0170
Phone: 715-428-2000
Natl: 800-243-5438
Fax: 715-428-2700

Myraid Industries
3454 E St
San Diego, CA 92102-3336
Phone: 619-232-6700
Natl: 800-999-6717
Fax: 619-232-4819

Myron L Co
6115 Corte del Cedro
Carlsbad, CA 92009
Phone: 619-438-2021
Fax: 619-931-9189

N

N B Olewine Co Inc, The
80 Maiden Lane 21st Floor
New York, NY 10038
Phone: 212-797-9244
Natl: 800-521-9244
Fax: 212-809-9397

NIST - Standard Reference Materials
Bldg 202 Rm 204
Gaithersburg, MD 20899
Phone: 301-975-6776
Fax: 301-948-3730

NSI Environmental Solutions Inc
2 Triangle Drive,
PO Box 12313
Research Triangle Park,
NC 27709
Phone: 919-549-8980
Fax: 919-544-0334

NUCON Intl Inc
7000 Huntley Road
Columbus, OH 43229
Phone: 614-846-5710
Natl: 800-992-5192
Fax: 614-431-0858

NUS Training Corp
910 Clopper Road
Gaithersburg, MD 20878-1399
Phone: 301-258-2500
Natl: 800-848-1717
Fax: 301-258-1205

Nalco Fuel Tech
PO Box 3031
Naperville, IL 60566-7031
Phone: 708-983-3242
Natl: 800-666-9988
Fax: 708-983-3240

National Controls Corp
1725 Western Drive
W Chicago, IL 60185
Phone: 708-231-5900
Natl: 800-323-2593
Fax: 708-231-1377

National Draeger Inc
PO Box 120
Pittsburgh, PA 15230
Phone: 412-787-8383
Natl: 800-922-5518
Fax: 412-787-2207

National Fluid Separators
827 Hanley Industrial Court
St Louis, MO 63144
Phone: 314-968-2838
Natl: 800-334-2460
Fax: 314-968-4773

National Instruments
6504 Bridge Point
Austin, TX 78730-5039
Phone: 512-794-0100
Natl: 800-433-3488
Fax: 512-794-8411

National Marker Co
100 Dexter St
Pawtucket, RI 02862
Natl: 800-453-2727
Fax: 800-338-0309

National Seal Co
1245 Corporate Blvd
No. 300
Aurora, IL 60504
Phone: 708-898-1161
Natl: 800-323-3820
Fax: 708-898-6566

National Technical Information Service
5285 Port Royal Road
Springfield, VA 22161
Phone: 703-487-4650
Natl: 800-553-6847
Fax: 703-321-8547

National Technical Systems
1536 E Valencia
Fullerton, CA 92631
Phone: 714-879-6110
Fax: 714-879-6117

Nederman Inc
6100 Hix Road
Westland, MI 48185
Phone: 313-729-3344
Natl: 800-575-0609
Fax: 313-729-3358

Nelson Enterprises
8 Evans Court
Huntington Station, NY 11746
Phone: 516-423-3056

Neoterik Health Technologies Inc
PO Box 128,
408 Main St
Woodsboro, MD 21798
Phone: 301-845-2777
Fax: 301-845-2213

Neri LLC
605 Parfet St No. 100
Lakewood, CO 80215
Phone: 303-238-0090
Natl: 800-845-5137
Fax: 303-238-2522

Neslab Instruments
PO Box 1178
Portsmouth, NH 03081-1178
Phone: 603-436-9444
Natl: 800-463-1522
Fax: 603-436-8411

Network Environmental Systems Inc (NES)
160 Blue Ravine Road No. F
Folsom, CA 95630
Phone: 916-985-3639
Natl: 800-637-2384
Fax: 916-985-0809

Netsch Inc
119 Pickering Way
Exton, PA 19341
Phone: 610-363-8010
Fax: 610-363-0971

New Pig Corp
1 Pork Ave
Tipton, PA 16684
Phone: 814-684-0101
Natl: 800-468-4647
Fax: 800-621-7447

Absorption Equipment;
Adsorbent Equipment;
Chemical Storage Buildings;
Cleaning Equipment-
Supplies; Clothing,
Protective; Compactors;
Cyclones; Defoaming/-
Degreasing Equipment;
Detectors; Diffusers; Drum
Deheaders; Drum Pumps;

Drums; Flame Arrestors;
Flushing/Cleaning
Equipment; Hazardous
Material Handling; Hazardous
Waste Containers; Hazardous
Waste Equipment; Laboratory
Equipment/Supplies; Lift
Stations; Mercury Spill
Cleanup Products; Noise
Deadening Supplies; Oil
Skimmers; Oil Spill Control
Equipment/Services;
Oil/Water Separation; Passive
Hydrocarbon Recovery
System; Protective Clothing;
Safety Equipment &
Products; Spill Control
Equipment/Products/-
Services; Test Equipment,
Misc; Training Videos
SEE AD ON PAGE 49, 94

New York Blower Co
7660 Quincy St
Willowbrook, IL 60521
Phone: 708-655-4881
Fax: 708-655-4897

NewAge Industries Inc
2300 Maryland Road,
PO Box K
Willow Grove, PA 19090-1799
Phone: 215-657-3151
Fax: 215-657-6594

Nibco Inc
500 Simpson Ave
Elkhart, IN 46516
Phone: 219-295-3000
Natl: 800-642-5463
Fax: 219-295-3307

Nicolet Instrument Corp
5225 Verona Road
Madison, WI 53711
Phone: 608-276-6100
Fax: 608-273-5046

Niifisk of America Inc
300 Technology Drive
Malvern, PA 19355
Phone: 610-647-6420
Natl: 800-645-3475
Fax: 610-647-6427

NIRO
410-997-8700

Niro Inc
9165 Rumsey Road
Columbia, MD 21045
Phone: 410-997-8700
Fax: 410-997-5021

Noell Inc
2411 Dulles Corner Park
No. 410
Herndon, VA 22071
Phone: 703-793-6500
Fax: 703-793-4974

Norcross Corp
255 Newtonville Ave
Newton, MA 02158
Phone: 617-969-7020
Fax: 617-969-3260

North American Environmental Corp
1100 Northmeadow Parkway
No. 108
Roswell, GA 30076
Phone: 770-740-1000
Natl: 800-989-0200
Fax: 770-740-0700

North American Green
14649 Highway 41 N
Evansville, IN 47711
Phone: 812-867-6632
Natl: 800-772-2040
Fax: 812-867-0247

North American Software Inc
PO Box 1197
Lake Forest, CA 92630
Phone: 714-457-9937
Natl: 800-966-5678
Fax: 714-457-9941

North East Environmental Products Inc
17 Technology Drive
W Lebanon, NH 03784
Phone: 603-298-7061
Fax: 603-298-7063

North Safety Products - Hand Protection Div
PO Box 70729
Charleston, SC 29415
Phone: 803-554-0660
Fax: 803-456-8317

North Safety Products, Safety Equipment Div
2000 Plainfield Pike
Cranston, RI 02921
Phone: 401-943-4400
Fax: 401-942-9360

North Safety Products
4090 Azalea Dr
Charleston, SC 29405-7528
Phone: 803-554-0660
Fax: 803-744-2857

Northern Lake Service Inc
400 N Lake Ave
Crandon, WI 54520-1286
Phone: 715-478-2777
Fax: 715-478-3060

Northwest Environmental Services Testing & Training
2000 Logston Blvd
Richland, WA 99352
Phone: 509-375-3268
Fax: 509-375-4838

Northwestern Carbon
PO Box 130
Red Bluff, CA 96080
Phone: 916-527-2664
Natl: 800-795-2664
Fax: 916-527-0544

Norton Chemical Process Products Corp
PO Box 350
Akron, OH 44309-0350
Phone: 216-673-5860
Fax: 216-677-7245

Novalynx Corp
PO Box 240
Grass Valley, CA 95742-0240
Phone: 916-477-5226
Natl: 800-321-3577
Fax: 916-477-8339

NuTech environmental corp.
800-321-8824

NuTech Environmental Corp
5350 N Washington St
Denver, CO 80216
Phone: 303-295-3702
Natl: 800-321-8824
Fax: 303-295-6145

Nuair Inc
2100 Fernbrook Lane
Plymouth, MN 55447
Phone: 612-553-1270
Natl: 800-328-3352
Fax: 612-553-0459

Nuclear Associates
100 Voice Road
Carle Place, NY 11514
Phone: 516-741-6360
Fax: 516-741-5414

OGCI Training Inc
PO Box 35448
Tulsa, OK 74153-0448
Phone: 918-742-7057
Natl: 800-821-5933
Fax: 918-742-2272

Oi Analytical
PO Box 9010
College Station, TX 77842-9010
Phone: 409-690-1711
Fax: 409-690-0440

OPW Fueling Components
9393 Princeton-Glendale Road,
PO Box 405003
Cincinnati, OH 45240-5003
Phone: 513-870-3100
Natl: 800-422-2525
Fax: 513-874-1231

ORS Environmental Systems
32 Mill St
Greenville, NH 03048
Phone: 603-878-2500
Natl: 800-228-2310
Fax: 603-878-3866

Occupational Health & Hygiene Corp of America
2777 Finley Road No. 20
Downers Grove, IL 60515
Phone: 708-543-1110
Fax: 708-543-1136

Odor Control Co Inc
PO Box 5740
Scottsdale, AZ 85261
Phone: 602-948-3956
Fax: 602-451-1010

Odor Management Inc
6186 Olson Memorial Highway
Golden Valley, MN 55422
Phone: 612-546-9730
Natl: 800-998-6367
Fax: 612-546-8539

Oetiker Inc
3305 Wilson St
Marette, MI 48453-0217
Phone: 517-635-3621
Fax: 517-635-2157

Ohaus Corp
29 Hanover Road
Florham Park, NJ 07932
Phone: 201-377-9000
Natl: 800-672-7722
Fax: 201-593-0359

Oil Skimmers Inc
12800 York Road,
PO Box 33092
Cleveland, OH 44133
Phone: 216-237-4600
Fax: 216-582-2759

Oilind Safety
1802 W Fourth St
Tempe, AZ 85281
Phone: 603-966-9410
Natl: 800-843-4855
Fax: 603-966-9444

Oklahoma State University Engineering Extension
512 E N
Stillwater, OK 74078-502
Phone: 405-744-5714
Fax: 405-744-5369

Omega Engineering Inc.
1 Omega Drive
Stamford, CT 06907
Phone: 203-359-4660
Natl: 800-826-6342
Fax: 203-359-7700
SEE AD ON PAGE 2

OnSite Offsite Inc
2040 Central Ave
Duarte, CA 91010
Phone: 818-303-2229
Fax: 818-303-1489

Onset Computer Corp
536 MacArthur Blvd,
PO Box 3450
Pocasset, MA 02559-3450
Phone: 508-563-9000
Fax: 508-563-9477

Or-Tec Inc
380 Solon Road No. 3
Bedford, OH 44146
Phone: 216-232-4224
Fax: 216-232-7775

Orbeco Analytical Systems Inc
185 Marne St
Farmingdale, NY 11735
Phone: 516-293-4110
Natl: 800-922-5242
Fax: 516-593-8258

Organic Waste Technologies Inc
7550 Lucern Drive
No. 110
Cleveland, OH 44130-6503
Phone: 216-891-0300
Fax: 216-891-8288

Orwak USA Inc
10820 Normandale Blvd
Minneapolis, MN 55437
Phone: 612-881-9200
Natl: 800-747-0449
Fax: 612-881-8578

Osmonics Inc
5951 Clearwater Drive
Minnetonka, MN 55343-8995
Phone: 612-933-2277
Natl: 800-848-1750
Fax: 612-933-0141
SEE AD ON PAGE 25

Ospery Biotechnics
2530 Trailmate Drive
Sarasota, FL 34243
Natl: 800-553-7785
Fax: 813-755-0626

Osram Sylvania Inc
100 Endicott St
Danvers, MA 01923
Phone: 508-777-1900
Natl: 800-544-4828
Fax: 508-750-2152

Ozact Inc
1528 N Dixie Hwy No. 1
Lake Worth, FL 33460
Phone: 407-588-2234
Nat'l: 800-329-2909
Fax: 407-588-2260

Ozonology Inc
1840 Oak Ave
Evanston, IL 60201
Phone: 708-866-1828
Nat'l: 800-523-5883
Fax: 708-866-1808

P

P&D
502-776-7776

P & D Systemtechnic
3026 Systemtechnic
Louisville, KY 40211
Phone: 502-776-7776
Fax: 502-776-7775

P & I Consulting Ltd
1699 Wall St No. 105
Mt Prospect, IL 60056
Phone: 708-734-5400
Fax: 708-734-5406

**P W Stephens
Contractors Inc**
727 S Ninth Ave
Industry, CA 91745
Phone: 818-330-7221
Nat'l: 800-322-4484
Fax: 818-369-2517

PACO Pumps
800 Koomey Road
Brookshire, TX 77423
Phone: 713-934-6012
Fax: 713-934-6090

PBM Inc
RD 6 Box 387-A,
Sandy Hill Road
Irwin, PA 15642
Phone: 412-863-0550
Nat'l: 800-964-4726
Fax: 412-864-9255

PLI Inc
PO Box 4051
Racine, WI 53404
Phone: 414-637-8170
Fax: 414-637-4090

PND Corp
14320 NE 21st St No. 6
Bellevue, WA 98007
Phone: 206-562-7252
Fax: 206-562-7254

PSG
14950 Heath Row
Forcat Parkway #200
Houston, TX 77032
Phone: 713-449-1500
Fax: 713-449-5970

Pace Inc
1710 Douglas Drive
Minneapolis, MN 55422
Phone: 612-544-5543
Nat'l: 800-990-7223
Fax: 612-525-3366

**Pace Transducer
Div of CJ Instruments Inc**
PO Box 570430
Tarzana, CA 91357
Phone: 818-996-4131
Fax: 818-700-8272

**Pacer Pumps
Div of ASM Industries Inc**
One Lark Ave
Leola, PA 17540-9512
Phone: 717-656-2161
Nat'l: 800-233-3861
Fax: 717-656-0477

**Pacific Environmental
Services Inc**
560 Herndon Parkway No. 200
Herndon, VA 22070
Phone: 703-471-8383
Fax: 703-481-8296
**Air Emissions Testing;
Computer Modeling (Air,
Groundwater, Hazard & Risk);
Computer Software,
Management; Computer
Software, Training;
Consulting Services;
Environmental Engineering;
Environmental Site
Assessment; Groundwater
Treatment/Services;
Hazardous Waste Services;
Indoor Air Quality; Industrial
Hygiene; Laboratory
Services/Testing; PCB
Testing; Radon, Testing &
Analysis; Soil Gas/Ground-
water Surveys; Stack
Emission Testing; Stormwater
Monitoring; Waste
Minimization**
SEE AD ON PAGE 56, 88

Packaging Research & Design
PO Box 678
Madison, MS 39130
Phone: 601-856-9791
Nat'l: 800-833-9364
Fax: 601-853-1202

Paco Pumps
800 Koomey Road
Brookshire, TX 77423
Phone: 713-934-6012
Nat'l: 800-955-5847
Fax: 713-934-6090

Pactec Inc
12365 Haynes St
Clinton, LA 70722
Phone: 504-683-8602
Nat'l: 800-272-2832
Fax: 504-683-8711

**Paragon Environmental
Systems Inc**
955 S Andreasen Drive
Escondido, CA 92029
Phone: 619-432-9839
Nat'l: 800-985-0054
Fax: 619-432-9848

Parker Hannifin Corp
17325 Euclid Ave
Cleveland, OH 44112
Nat'l: 800-272-7537
Fax: 216-486-0618

**Parker Hannifin
Corp/Q C Div**
8145 Lewis Road
Minneapolis, MN 55427
Phone: 612-544-7781
Nat'l: 800-272-7537
Fax: 612-544-3418

Parkline Inc
PO Box 65
Winfield, WV 25213
Phone: 304-586-2113
Nat'l: 800-786-4855
Fax: 301-586-3842

Peek Measurement
10335 Landsbury
Houston, TX 77099
Phone: 713-879-3700
Fax: 713-498-7721

Pego Systems Inc
PO Box 90038
Long Beach, CA 90809
Phone: 310-426-1321
Fax: 310-490-0633

Peoria Disposal Co
4700 N Sterling Ave
Peoria, IL 61614
Phone: 309-688-0760
Fax: 309-688-0881

Pepcon Systems Inc
3770 Howard Hughes Parkway
No. 340
Las Vegas, NV 89109
Phone: 702-735-2324
Fax: 702-735-9456

Performance Analytical Inc
20954 Osborne St
Canoga Park, CA 91304
Phone: 818-709-1139
Fax: 818-709-2915

Perkin-Elmer Corp
761 Main Ave
Norwalk, CT 06859
Phone: 203-762-4000
Nat'l: 800-762-4000
Fax: 203-762-4222

Permit Tracker Software
PO Box 033846
Indianapolis, FL 32903-3846
Phone: 407-723-6213
Nat'l: 800-365-3962

**Peter George
Associates Inc**
40 Prince St
New York, NY 10012-3431
Phone: 212-336-9700
Fax: 212-336-9759

Petrol REM Inc
2275 Swallow Hill Road
Blidg 2500
Pittsburgh, PA 15220
Phone: 412-279-9745
Nat'l: 800-246-2275
Fax: 412-279-1367

Phelps Fan Inc
PO Box 190718,
10701 Interstate 30
Little Rock, AR 72119
Phone: 501-568-5550
Fax: 501-568-3363

Phillips Driscopipe
2929 N Central Expressway
Richardson, TX 75080
Phone: 214-783-2666
Nat'l: 800-527-0662
Fax: 214-783-2616

Phonetics Inc
901 Tryens Road
Aston, PA 19014
Phone: 610-558-2700
Fax: 610-558-0222

**Photovac Monitoring
Instruments**
25-B Jeffry Blvd West
Deer Park, NY 11729
Phone: 516-254-4199
Fax: 516-254-4284
SEE AD ON PAGE 51

Piqua Waste Equipment Inc
PO Box 911
Piqua, OH 45356
Phone: 513-773-2464
Nat'l: 800-543-8950
Fax: 513-778-1320

**Pittsburgh Activated
Carbon Services Inc**
409 Meade Drive
Corapolis, PA 15108
Phone: 412-457-6576
Nat'l: 800-367-2587
Fax: 412-457-1214

Plast-O-Matic Valves Inc
1384 Pompton Ave
Cedar Grove, NJ 07009
Phone: 201-256-3000
Fax: 201-256-4745

Plasti-Fab Inc
PO Box 100
Tualatin, OR 97062
Phone: 503-692-5460
Fax: 503-692-1145

Plastic Fusion Fabricators Inc
3455 Stanwood Blvd
Huntsville, AL 35811
Phone: 205-852-0378
Nat'l: 800-356-1480
Fax: 205-852-0388

Plastronics Inc
PO Box 580404
Houston, TX 77258
Phone: 713-335-1318
Fax: 713-335-1408

Plexco
1050 Busse
Benseville, IL 60106
Phone: 708-350-3700
Fax: 708-350-2704

**Pollution Research &
Technology Inc (PRT)**
12 Medics No. 200
Laguna Hills, CA 92656
Phone: 714-588-9473
Fax: 714-588-9573

Poly Processing Co
2201 Old Sterling Road
Monroe, LA 71211
Phone: 318-343-7565
Nat'l: 800-529-9871
Fax: 318-343-8795

Poly-Flex Inc
2000 W Marshall Drive
Grand Prairie, TX 75051
Phone: 214-647-4374
Nat'l: 800-527-3322
Fax: 214-988-8331

PolySpec Corp
6614 Gant Road
Houston, TX 77066
Phone: 713-397-0033
Fax: 713-397-6512

Polybac Corp
3894 Courtney St
Bethlehem, PA 18017-8999
Phone: 610-867-7338
Nat'l: 800-523-9385
Fax: 610-861-0991

Polyfoam Packers Corp
2320 Foster Ave
Wheeling, IL 60090
Phone: 847-398-0110
Nat'l: 800-227-8865
Fax: 847-398-0653

Pope Scientific Inc
PO Box 495
Menomonee Falls, WI 53051
Phone: 414-251-9300
Fax: 414-251-7387

Porta-Fab Corp
18080 Chesterfield Airport Road
Chesterfield, MO 63005
Phone: 314-537-5555
Nat'l: 800-325-3781
Fax: 312-453-7295

**Portec C E D
Environmental Products**
700 W 21 St,
PO Box 20
Yankton, SD 57078
Phone: 605-665-8770
Fax: 605-665-8858

Powder Coating Institute Inc
2121 Eisenhower Ave
Alexandria, VA 22314
Phone: 703-684-1770
Nat'l: 800-988-2628
Fax: 703-684-1771

Power Plant Services
2500 W Jefferson
Fort Wayne, IN 46802
Phone: 219-432-6716
Fax: 219-436-3340

Praxair Inc
39 Old Ridgebury Road
Danbury, CT 06810-5113
Phone: 716-879-4077
Nat'l: 800-772-9247
Fax: 716-879-2040

**Precision Environmental
International Inc**
401 Wood St
Pittsburgh, PA 15222
Phone: 412-765-2297
Fax: 412-765-2362

Precision Quincy Corp
1625 N Lake Shore Drive
Woodstock, IL 60098
Phone: 815-338-2675
Nat'l: 800-338-0079
Fax: 815-338-2960

Precision Wire Products Inc
207 East Brown St,
PO Box 103
Blairsville, PA 15717
Phone: 412-459-5601
Fax: 412-459-0559

Presray Corp
159 Charles Colman Blvd
Pawling, NY 12564
Phone: 914-955-1220
Fax: 914-855-1139

Primatex Inc
445 Hutchinson Ave No. 200
Columbus, OH 43235
Phone: 614-841-9800
Fax: 614-941-9805

ProBios Inc
4367 Mensha Place
San Diego, CA 92130
Phone: 619-481-7025
Fax: 619-481-0443

Probiotic Solutions
201 S Roosevelt Ave
Chandler, AZ 85226
Phone: 602-961-1220
Nat'l: 800-961-1220
Fax: 602-961-3501



Process Combustion Corp
5460 Horning Road
Pittsburgh, PA 15236
Phone: 412-655-0955
Fax: 412-655-0961

Proco Products Inc
PO Box 590
Stockton, CA 95201-0590
Phone: 209-943-6088
Natl: 800-344-3246
Fax: 209-943-0242

Prodeva Inc
100 Jerry Dr
Jackson Center, OH 45334
Phone: 513-596-6713
Natl: 800-999-3271
Fax: 513-596-5145

Progressive Equipment Corp
413 E Ninth St
Erie, PA 16503
Phone: 814-452-4363
Natl: 800-548-6089
Fax: 814-459-3094

Prosys Corp
187 Billerica Road
Chelmsford, MA 01824
Phone: 508-250-4940
Fax: 508-250-4977

Protec
7136 S Yale No. 200
Tulsa, OK 74136
Phone: 918-493-6101
Fax: 918-493-2054

Prototech Co, The
32 Fremont St
Needham, MA 02194
Phone: 617-444-5188
Fax: 617-444-0130

Proud Data Service
1947 Dwight Way No. 4
Berkeley, CA 94704
Phone: 510-486-0453
Fax: 510-649-9207

Pumpex Inc
103A Molasses Hill Road
Lebanon, NJ 08833
Phone: 908-730-7004
Fax: 908-730-7580

Purestream Inc
PO Box 68
Florence, KY 41022-0068
Phone: 606-371-9898
Fax: 606-371-3577

Q

QED Environmental Systems Inc
PO Box 3726
Ann Arbor, MI 48103
Phone: 313-995-2547
Natl: 800-624-2026
Fax: 313-995-1170

R

R D McMillan Co Inc
2425-D Williams Drive
Georgetown, TX 78628
Phone: 512-863-0231
Natl: 800-861-0231
Fax: 512-863-0671

R E Wright Environmental Inc
3240 Schoolhouse Road
Middletown, PA 17057-3595
Phone: 717-944-5501
Natl: 800-944-6778
Fax: 717-948-9398

R M Young Co
2801 Aero Park Drive
Traverse City, MI 49686
Phone: 616-946-3980
Fax: 616-946-4772
SEE AD ON PAGE #

R P Adams Co Inc
225 E Park Drive
Buffalo, NY 14240
Phone: 716-877-2608
Fax: 716-877-9385

RAMCON Environmental Corp
6707 Fletcher Creek Cove
Meyers, PA 16805
Phone: 814-337-3133
Natl: 800-458-4567
Fax: 814-337-0400

RGF Environmental Systems Inc
3875 Fiscal Court
W Palm Beach, FL 33404
Phone: 407-848-1826
Natl: 800-842-7771
Fax: 407-848-9454

RHH Foam Systems Inc
6001 S Pennsylvania Ave.
PO Box 752
Cudahy, WI 53110-0752
Phone: 414-744-6066
Natl: 800-657-0702
Fax: 414-744-8227

RJ Environmental Inc
6197 Cornerstone Ct E
No. 108
San Diego, CA 92121
Phone: 619-455-7688
Fax: 619-455-7689

RKI Instruments Inc
1855 Whipple Road
Hayward, CA 94544
Phone: 510-441-5656
Natl: 800-754-5165
Fax: 510-441-5650

RMJ Machinery Inc
4915 Van Epps
Cleveland, OH 44131
Phone: 216-351-8900

RMT Inc
PO Box 8923
Waukesha, WI 53186
Phone: 608-831-4444
Fax: 608-831-3334

Rabrko Environmental Liners Inc
4222 S Pulaski Road
Chicago, IL 60632
Phone: 312-890-5350
Natl: 800-621-8546
Fax: 312-890-4669

Racal Health & Safety Inc
7305 Executive Way
Frederick, MD 21704
Phone: 301-695-8200
Natl: 800-682-9500
Fax: 301-695-4413

Radian Corp
PO Box 201088
Austin, TX 78720-1088
Phone: 512-458-8950
Natl: 800-848-7837
Fax: 512-454-0268

Radon Detection Systems Inc
2450 Central Ave No. A-1
Boulder, CO 80301
Phone: 303-444-5253
Natl: 800-627-2366
Fax: 303-444-1331

Rae Systems Inc
680 W Maude Ave No 1
Sunnyvale, CA 94086
Phone: 408-481-4999
Fax: 408-481-4995

Rain for Rent
3404 State Road,
PO Box 2248
Bakersfield, CA 93303
Phone: 805-399-9124
Natl: 800-742-7246
Fax: 805-393-1542

Rampactor Inc
362 S Main
Clearfield, UT 84015
Phone: 801-773-1311
Natl: 800-272-7716
Fax: 801-773-8608

Raven Lining Systems
1024 N Lansing
Tulsa, OK 74106
Phone: 918-584-2810
Natl: 800-324-2810
Fax: 918-582-4311

Raytheon Environmental Svcs/ Raytheon Engineers & Construction
13105 Northwest Freeway
No. 200
Houston, TX 77040
Phone: 713-329-4000

Recon Environmental Corp
5 Johnson Drive,
PO Box 130
Raritan, NJ 08869
Phone: 908-526-1000
Fax: 908-526-7886

Red Bird Service
205 Western Ave,
PO Box 155
Osgood, IN 47037
Phone: 812-689-4040
Natl: 800-428-3502
Fax: 812-689-4061

Reef Industries Inc
PO Box 750250
Houston, TX 77275-0250
Phone: 713-507-4200
Natl: 800-231-6074
Fax: 713-507-4295

RegScan Inc
330 Pine St,
1 Executive Plaza No. 300
Williamsport, PA 17701
Phone: 717-323-1010
Natl: 800-734-7226
Fax: 717-323-8028

Regenesis Bioremediation Products
27130A Paseo Espada No. 1407
San Juan Capistrano, CA 92675
Phone: 714-443-3136
Fax: 714-443-3140

Remco Products Corp
4735 W106th St,
PO Box 698
Zionsville, IN 46077
Phone: 317-876-9856
Fax: 317-876-9858

Remedial Systems Inc
56 Leonard St
Foxboro, MA 02035
Phone: 508-543-1512
Fax: 508-543-7485

Remediation Inc
PO Box 97
Dover, PA 17315
Phone: 717-292-4432
Fax: 717-292-7569

Remediation Service Intl
2060 Knoll Drive
Ventura, CA 93003
Phone: 805-644-5892
Fax: 805-654-0720

Remtech Inc
PO Box 2623
Longmont, CO 80502
Phone: 303-772-6825
Fax: 303-772-6827

Research Products/Blankenship
2639 Andjion Drive
Dallas, TX 75220
Phone: 214-358-4238
Natl: 800-527-5551
Fax: 214-350-7919

Resources Conservation Co
3006 Northrup Way
Bellevue, WA 98004
Phone: 206-828-2400
Fax: 206-828-0526

Restek Corp
110 Benner Circle
Bellefonte, PA 16823-8812
Phone: 814-353-1300
Natl: 800-356-1688
Fax: 814-353-1310

Revere Products
PO Box 35311
Cleveland, OH 44135
Natl: 800-321-1976
Fax: 800-966-0502

Rhombus Technology
PO Box 1619,
County Road 6
Detroit Lakes, MN 56502
Phone: 218-847-4786
Natl: 800-746-6287
Fax: 218-847-4801

Ricca Chemical Co
448 West Fork Drive
Arlington, TX 76012
Phone: 817-461-5601
Fax: 817-795-8848

Right-To-Know Training Institute
2212 Port of Tacoma Road
Tacoma, WA 98421
Phone: 206-383-1714
Fax: 206-383-1722

Rite in the Rain Fieldbooks
2212 Port of Tacoma Road
Tacoma, WA 98421
Phone: 206-383-1714
Fax: 206-383-1722

Robroy Industries
River Road
Verona, PA 15147
Phone: 412-828-2100
Fax: 412-828-4801

Rocky Mtn Ctr for Occup & Enviro Health
Bldg 512 Univ of Utah
Salt Lake City, UT 894112
Phone: 801-581-5710
Fax: 801-585-5275

Rollins Environmental Services
One Rollins Plaza,
PO Box 2349
Wilmington, DE 19899
Phone: 302-426-2700
Natl: 800-992-4587
Fax: 302-426-3873

Ronk Electrical Industries Inc
PO Box 160,
106 E State St
Nokomis, IL 62075-0160
Phone: 217-563-8333
Natl: 800-221-7666
Fax: 217-563-8336



Roper Pump Co
PO Box 269
Commerce, GA 30529
Phone: 706-335-5551
Natl: 800-944-6769
Fax: 706-335-5505

Rosemount Analytical Inc
1201 N Main St
Orville, OH 44667-0901
Phone: 216-682-9010
Natl: 800-433-6076
Fax: 216-684-4458

Rosemount Analytical Inc
2400 Barranca Parkway
Irvine, CA 92714
Phone: 714-863-1181
Natl: 800-854-8257
Fax: 714-474-7250

Ross Analytical Services Inc
16433 Foltz Industrial Parkway
Strongsville, OH 44136
Phone: 216-572-3200
Natl: 800-325-7737
Fax: 216-572-7620

Rotex Inc
1480 Knowlton St
Cincinnati, OH 45223
Phone: 513-541-1236
Natl: 800-453-2321
Fax: 513-541-4888

Rotobec
200 Industrielle
Ste-Justine, Quebec,
Canada, CN G0R 1Y0
Phone: 418-383-3002
Fax: 418-383-5334

Rotronic Instrument Corp
160 E Main St
Huntington, NY 11743
Phone: 516-427-3898
Fax: 516-427-3902
SEE AD ON PAGE 64

Roy F Weston Inc
1 Weston Way
West Chester, PA 19380
Phone: 610-701-3000
Fax: 610-701-3186

Royce Instrument Corp
13555 Gentilly Road
New Orleans, LA 70129
Phone: 504-254-8888
Natl: 800-347-3505
Fax: 504-254-8855

Rubb Building Systems
PO Box 711,
Sanford Airport
Sanford, ME 04073
Phone: 207-324-2877
Natl: 800-289-7822
Fax: 207-324-2347

Rusmar Inc
216 Garfield ave
West Chester, PA 19380
Phone: 610-436-4314
Natl: 800-733-3626
Fax: 610-436-8436

Rustrak Instruments
1900 S County Trail
E Greenwich, RI 02818
Phone: 401-884-6800
Natl: 800-332-3202
Fax: 401-884-4872

S

S & G Enterprises Inc
N115 W 19000 Edison Drive
Germantown, WI 53022-3024
Phone: 414-251-8300
Natl: 800-233-3721
Fax: 414-251-1616

S C Altman & Associates
2424 W 207th St
Olympia Fields, IL 60461
Phone: 708-747-3399
Fax: 708-471-1248

S J Electro Systems Inc
PO Box 1619,
County Road 6
Detroit Lakes, MN 56502
Phone: 218-847-1317
Fax: 218-847-4617

S W Cole Engineering Inc
6 Liberty Drive
Bangor, ME 04401
Phone: 207-848-5714
Fax: 207-848-2403

SCI-TEC Instruments Inc
1526 Fletcher Road
Saskatoon, CN S7m 5M1
Phone: 306-934-0101
Fax: 306-978-2339

SERCO Laboratories
1931 W County Road C-2
St Paul, MN 55113
Phone: 612-636-7173
Fax: 612-636-7178

SKC Inc
863 Valley View Road
Eighty Four, PA 15330
Phone: 412-941-9701
Natl: 800-752-8472
Fax: 412-941-1369

SKS Bottle & Packing Inc
3 Knabner Road
Mechanicville, NY 12118
Phone: 518-899-7488
Fax: 517-899-7490

SRI Instruments
3882 Delamo Blvd
No. 601
Torrance, CA 90503
Phone: 310-214-5092
Fax: 310-214-5097

SRS Crisafulli Inc
Crisafulli Drive
Glendive, MT 59330-1051
Phone: 403-365-3393
Natl: 800-442-7867
Fax: 406-365-2249

SRS Industrial Engineering Inc
6101 Ball Road No. 303
Cypress, CA 90630
Phone: 714-827-1977
Fax: 714-828-0765

SSI Shredding Systems Inc
9760 SW Freeman Drive
Wilsonville, OR 9707-9286
Phone: 503-682-3633
Natl: 800-537-5733
Fax: 503-682-1704

SSOE Inc
1001 Madison Ave
Toledo, OH 43624
Phone: 419-255-3830
Fax: 419-255-6101

STP Specialty Technical Publishers Inc
267 W Esplanade Ave
N Vancouver, British Columbia,
Canada, CN V7M 1A5
Phone: 604-983-3434
Natl: 800-251-0381
Fax: 604-983-2228

Safe Environmental Storage
180 Devon Ave
Bensenville, IL 60106
Natl: 800-593-7233
Fax: 800-593-0345

Safe-T-Tank Corp
30 Dowers Drive
Meriden, CT 06451
Phone: 203-237-6320
Natl: 800-536-8910
Fax: 203-235-2749

Safeco Products Co
9300 W Research Center Road
New Hope, MN 55428
Phone: 612-536-6700
Natl: 800-328-3020
Fax: 612-536-6777

Safety Storage Inc
2301 Bert Drive
Hollister, CA 95023
Phone: 408-637-5955
Natl: 800-344-6539
Fax: 408-637-7405
SEE AD ON PAGE 39, 79



Safety-Kleen Corp
1000 N Randall Road
Elgin, IL 60123-7854
Phone: 708-697-8460
Natl: 800-323-5040
Fax: 708-468-8515

Samsco Inc
18 Cote Ave
Gofstown, NH 03045
Phone: 603-668-7111
Fax: 603-647-0537
Bailer Feedwater Treatment

Equipment; Chillers; Cooling
Tower Water Treatment;
Distillation Equipment;
Evaporation Equipment;
Filtration Systems; Groundwater
Treatment/Services; Hazardous
Material/Waste Disposal;
Hazardous Waste Recycling Ion
Exchange; Oil/Water Separation
Recycling Equipment/
Services; Reverse Osmosis
Equipment; Separation System;
Solvent Recovery Systems;
Stormwater Treatment;
Ultrafiltration Equipment;
Wastewater Treatment
Systems; Water/Wastewater
Treatment Equipment

Sanborn Technologies
25 Commercial Ave
Wrentham, MA 02093
Phone: 508-384-3181
Natl: 800-343-3381
Fax: 508-384-5346

Saturn Shredders Div of MAC Corp
201 E Shadygrove Road
Grand Prairie, TX 75050
Phone: 214-790-7800
Fax: 214-790-8733

Sauereisen
160 Gamma Drive
Pittsburgh, PA 15238
Phone: 412-963-0303
Fax: 412-963-7620

Schneider Instrument Co
8115 Camargo Road
Cincinnati, OH 45243
Phone: 513-561-6803
Fax: 513-527-4375

Schonstedt Instrument Co
1775 Wiehle Ave
Reston, VA 22090-5199
Phone: 703-471-1050
Natl: 800-999-8280
Fax: 703-471-1795

Schuller International Inc
PO Box 5108
Denver, CO 80217
Phone: 303-978-4900
Natl: 800-654-3103
Fax: 303-978-2318

Scientific Dust Collectors
4104 West 126th St
Alsip, IL 60658-1996
Phone: 708-597-7090
Fax: 708-597-0313



Scientific Sales Inc
PO Box 6725
Lawrenceville, NJ 08648
Phone: 609-844-0055
Natl: 800-788-5666
Fax: 609-844-0466

Scott Lawson Group Inc, The
PO Box 3304
Concord, NH 03302-3304
Phone: 603-228-3610
Natl: 800-645-7674
Fax: 603-228-3871

Scott Specialty Gases
6141 Easton Road
Box 310
Plumsteadville, PA 18949
Phone: 215-766-8861
Fax: 215-766-2476

Screw Conveyor Corp
700 Hoffman St
Hammond, IN 46327
Phone: 219-931-1450
Natl: 800-805-6527
Fax: 219-931-0209

SeaMetrics Inc
PO Box 1589
Kent, WA 98035
Phone: 206-872-0284
Fax: 206-872-0285

Seagull Technical Services
PO Box 1812
San Leandro, CA 94577
Phone: 510-582-3127
Fax: 510-581-6181

Seaman Corp
1000 Venture Blvd
Wooster, OH 44691
Phone: 423-691-9476
Fax: 423-539-8294

Sebright Products
127 N Water St
Hopkins, MI 49328
Phone: 616-793-7183
Natl: 800-253-0532
Fax: 616-793-4022

Seghers Dinamec Inc
351 Thornton Road
No. 115
Lithia Springs, GA 30057
Phone: 770-739-4205
Fax: 770-944-2236

Sensidyne Inc
16333 Bay Vista Drive
Clearwater, FL 34620
Phone: 813-530-3602
Natl: 800-451-9444
Fax: 813-539-0550

Sensor Electronics Corp
5500 Lincoln Drive
Minneapolis, MN 55436
Phone: 612-938-9486
Natl: 800-285-3651
Fax: 612-938-9617

Sentex Systems Inc
553 Broad Ave
Ridgefield, NJ 07657
Phone: 201-945-3694
Fax: 201-941-6064

Sentry Polymers Inc
5500 East Highway 332,
PO Box 2076
Freeport, TX 77542
Phone: 409-233-0312
Natl: 800-231-2544
Fax: 409-233-4922

Serengeti Environmental
PO Box 772503
Houston, TX 77215-2503
Phone: 713-266-4300
Fax: 713-266-4339

Serfilco Ltd
1777 Shermer Road
Northbrook, IL 60062
Phone: 847-559-1777
Natl: 800-323-5431
Fax: 847-559-1995

Serio-Us Lock
7466 New Ridge Road
No. 20
Hanover, MD 21076
Phone: 410-850-8380
Natl: 800-245-6251
Fax: 410-850-8362

Serpentix Conveyor Corp
9085 Marshall Court
Westminster, CO 80030
Phone: 303-430-8427
Fax: 303-430-7377

Servomex Co Inc
90 Kerry Place
Norwood, MA 02062
Phone: 617-769-7710
Natl: 800-862-0200
Fax: 617-769-2834

Sethco Div Met-Pro Corp
70 Arkay Drive
Hauppauge, NY 117788
Phone: 516-435-0530
Fax: 516-435-0654

Seton Identification Products
PO Box 819
Brantford, CT 06405-0819
Phone: 203-488-8059
Natl: 800-345-7819
Fax: 800-345-7819

Sevenson Environmental Services Inc
2749 Lockport Road
Niagara Falls, NY 14302
Phone: 716-284-0431
Fax: 716-284-1796

Sewall, James W
PO Box 433,
147 Center St
Old Town, ME 04468
Phone: 207-827-4456
Natl: 800-648-4202
Fax: 207-827-3641

Sharp & Associates Inc
982 Crupper Ave
Columbus, OH 43229
Phone: 614-841-4650
Fax: 614-841-4660

Shields Environmental Corp
19800 MacArthur Blvd
No. 510A
Irvine, CA 92715
Phone: 714-260-3880
Natl: 800-588-8439
Fax: 714-260-2200

Shimadzu Scientific Instruments Inc
7102 Riverwood Drive
Columbia, MD 21046
Phone: 410-381-1227
Natl: 800-477-1227
Fax: 410-381-1222

Shred-Tech
295 Pinebush Road
Cambridge, Ontario,
Canada, CN N1T 1B2
Phone: 519-621-3560
Natl: 800-465-3214
Fax: 519-621-0688

Siemens Energy & Automation Inc
100 Technology Drive
Alpharetta, GA 30024
Phone: 770-740-3944
Fax: 770-740-3998

Sierra Monitor Corp

Sierra Monitor Corp

1991 Tarob Court
Milpitas, CA 95035
Phone: 408-262-6611
Natl: 800-727-4377
Fax: 408-262-9042

Site Assessment Software

PO Box 033846
Indialantic, FL 32903-3846
Phone: 407-723-6213
Natl: 800-365-3962

Site Reclamation Systems Inc

29511 C R 561
Tavares, FL 32778
Phone: 904-343-1715
Fax: 904-343-7408

Skolnik Industries Inc

4900 S Kilbourn Ave
Chicago, IL 60632-4593
Phone: 312-735-0700
Fax: 312-735-7257

Slickbar Products Corp

18 Beach St
Seymour, CT 06483
Phone: 203-888-7700
Natl: 800-921-2221
Fax: 203-888-7720

Slikwik Sorbents

PO Box 119
Maumee, OH 43537
Phone: 419-893-5050
Natl: 800-331-3747
Fax: 419-891-6539

Smith & Loveless Inc

14040 Santa Fe Trail Drive
Lenexa, KS 66215
Phone: 913-888-5201
Fax: 913-888-2173

Smith Fiberglass

Products Inc
2700 W 65th St
Little Rock, AR 72209
Phone: 501-568-4010
Fax: 501-568-4465

Softshel Inc

PO Box 10813
Midwest City, OK 73140
Phone: 405-733-2002
Fax: 405-733-2000
SEE AD ON PAGE 67, 91

Soil Solutions Inc

1703 Vargrave St
Winston-Salem, NC 27107
Phone: 910-725-5844
Fax: 910-725-6244

Solinst Canada Ltd

35 Todd Road
Georgetown, ONT
Canada, L7G4R8
Phone: 905-873-2255
Fax: 905-873-1992
SEE AD ON PAGE 69, 115

Solomart - Neotronics

26 Pearl St
Norwalk, CT 06850
Phone: 203-849-3111
Natl: 800-932-4500
Fax: 203-847-9320

Solox

Div of Solar Kinetics Inc
10635 King William Drive
Dallas, TX 75220
Phone: 214-556-2376
Natl: 800-949-7654
Fax: 214-869-4158

Solvay Interco

3333 Richmond Ave
Houston, TX 77098
Phone: 713-525-6500
Natl: 800-462-3769
Fax: 713-524-9032

Solvent Recovery

Systems Inc
24022 Yoakum
Huffman, TX 77336
Phone: 713-324-3254
Natl: 800-367-5773
Fax: 713-324-3952

Somat Corp

855 Fox Chase
Coatesville, PA 19320
Phone: 610-384-7000
Fax: 610-380-8500

Southern Methodist University

PO Box 750335
Dallas, TX 75275-0335
Phone: 214-768-1452
Fax: 214-768-3778

Sparling

Instruments Co Inc
4097 N Temple City Blvd
El Monte, CA 91731
Phone: 818-444-0571
Fax: 818-444-2314

Speakman Co

PO Box 191
Wilmington, DE 19899-0191
Phone: 302-764-9100
Fax: 301-764-1956

Specialty Mfg Co, The

5858 Centerville Road
St Paul, MN 55127
Phone: 612-653-0599
Fax: 612-653-0989



Spectra Gases Inc

277 Coit St
Irvington, NJ 07111
Phone: 201-372-2060
Natl: 800-932-0624
Fax: 201-372-8551



Spectrex Corp

3580 Haven Ave
Redwood City, CA 94063
Phone: 415-365-6567
Natl: 800-822-3940
Fax: 415-365-5845

Spectrogram Corp

385 State St
North Haven, CT 06473
Phone: 203-281-0121
Natl: 800-839-9050
Fax: 203-248-8887

Spectronics Corp

956 Brush Hollow Road,
PO Box 483
Westbury, NY 11590
Phone: 516-333-4840
Natl: 800-274-8888
Fax: 516-333-4859

Spencer Turbine Co, The

600 Day Hill Road
Windsor, CT 06095
Phone: 860-688-8361
Natl: 800-232-4321
Fax: 860-688-0098

Spraying Systems Co

PO Box 7900
Wheaton, IL 60189-7900
Phone: 708-665-5000
Fax: 708-260-0842

Sprung Instant

Structures Inc
9600 A E 104th Ave
Henderson, CO 80640
Phone: 303-287-3898
Natl: 800-528-9899
Fax: 303-287-3921

Stanley Hydraulic Tools

3810 SE Naef Road
Miwaukic, OR 97267-5698
Phone: 503-659-5660
Fax: 503-652-1780

Stanley Storage Systems

11 Grammes Road
Allentown, PA 18103
Phone: 610-797-6600
Fax: 610-776-3895

Staplex Air Sampler Div

777 Fifth Ave
Brooklyn, NY 11232
Phone: 718-768-3333
Natl: 800-221-0822
Fax: 718-965-0750

Star Systems

Filtration Div/Hilliard
of South Carolina
PO Box 518
Timmonsville, SC 29161
Phone: 803-346-3101
Natl: 800-845-5381
Fax: 803-346-3736

Steele Inc

PO Box 7304
Kingston, WA 98346
Phone: 360-297-4555
Fax: 360-297-2816

Stiles-Kem Div

Met-Pro Corp
3301 Sheridan Road
Zion, IL 60099
Phone: 708-746-8334
Natl: 800-562-1537
Fax: 708-746-8341

Stockhausen Inc

2401 Doyle St
Greensboro, NC 27406
Phone: 910-333-3500
Natl: 800-334-0242
Fax: 910-333-3518

Stokes Vacuum Inc

5500 Tabor Road
Philadelphia, PA 19120
Phone: 215-831-5400
Fax: 215-831-5420



Stord Inc

309 Regiona Road S
Greensboro, NC 27409-9674
Phone: 910-668-7727
Fax: 910-668-0537

StratiFact Software

4175 Harlan St No. 200
Wheat Ridge, CO 80033-5150
Phone: 303-423-0221
Natl: 800-783-0250
Fax: 303-423-8757

Strong Environmental Inc

6264 Crooked Creek Rd No. 11
Norcross, GA 30092
Phone: 770-409-1500
Natl: 800-778-7664
Fax: 770-409-1449

Structural North America

220 Park Drive
Charlton, OH 44024
Phone: 216-286-4116
Fax: 216-286-6504
SEE AD ON PAGE 22

Structure Probe

Inc/SPI Supplies
PO Box 656
West Chester, PA 19381-0656
Phone: 610-436-5400
Natl: 800-242-4774
Fax: 610-436-5755



Suburbia Systems Corp

149 Miller St
Wilkes-Barre, PA 18705
Phone: 717-823-4037
Natl: 800-782-3384
Fax: 717-829-4515

Sumitomo

4200 Holland Blvd
Chesapeake, VA 23223
Phone: 804-485-3355
Fax: 804-485-3075



Summit Analyzers

7066 G Las Positas Road
Livermore, CA 94550
Phone: 510-443-4210
Natl: 800-344-0321
Fax: 510-443-0251

Sunshine Technology Corp

2475 Albany Ave
West Hartford, CT 06117
Phone: 860-232-9227
Fax: 860-523-0170

Superior Industrial

Maintenance Co Inc
PO Box 535,
540 S Lane Road
Mount Holly, NC 28120
Phone: 704-827-0001
Natl: 800-532-7511
Fax: 704-827-0013

TRC Environmental Corp

Superior Signal Co Inc

PO Box 96
Spotswood, NJ 08884
Phone: 908-251-0800

Superior Special Services Inc

PO Box 500, 222 E Main Port
Washington, WI 53074
Phone: 414-284-9101
Natl: 800-932-6216
Fax: 414-284-9208

Surface Combustion Inc

1700 Indian Wood Circle
Maumee, OH 43537
Phone: 419-891-7150
Natl: 800-537-8980
Fax: 419-891-7151

Sverdrup Environmental Inc

13723 Riverport Drive
Maryland Heights, MO 63043
Phone: 314-436-7600
Natl: 800-325-7910
Fax: 314-770-5110

Swagelok Companies, The

31400 Aurora Road
Solon, OH 44139
Phone: 216-349-5934
Fax: 216-349-5843

Sweepster Inc

2800 N Zeeb Road
Dexter, MI 48130
Phone: 313-996-9116
Natl: 800-456-7100
Fax: 313-996-9014

Swenson Process

Equipment Inc
15700 Lathrop Ave
Harvey, IL 60426-5198
Phone: 708-331-5500
Fax: 708-331-5559

Syborn Chemicals Inc

PO Box 66
Birmingham, NH 08011
Phone: 609-893-1100
Natl: 800-678-0020
Fax: 609-894-8641

Syntech Inc

700 Terrace Lane
Paducah, KY 42003
Phone: 502-898-7303
Fax: 502-898-7306



T Q M Engineering

58 Bay Road
Barrington, RI 02806
Phone: 401-245-5558
Fax: 401-245-9444

TENAX Corp

4800 E Monument St
Baltimore, MD 21205
Phone: 410-522-7000
Natl: 800-356-8495
Fax: 410-522-7015

TNT Technology Co

2121 W University Drive
No. 123
Tempe, AZ 85281
Phone: 602-966-9891
Fax: 602-968-9469

TRC Environmental Corp

Five Waterside Crossing
Windsor, CT 06095
Phone: 203-289-8631
Natl: 800-872-5601
Fax: 203-298-6399
SEE AD ON PAGE 32

Tapecoat Company, The
1527 Lyons Street
Evanston, IL 60201-3551
Phone: 708-866-8500
Natl: 800-758-6041
Fax: 708-866-8596

Tarby of Delaware Inc
2205 E L Anderson Blvd
Claremore, OK 74017
Phone: 918-341-8282
Natl: 800-854-1879
Fax: 918-341-8297

Taylor Technologies Inc
31 Loveton Circle
Sparks, MD 21152
Phone: 410-472-4340
Natl: 800-837-8548
Fax: 410-771-4291

Technical Heaters Inc
710 Jessie st
San Fernando, CA 91340
Phone: 818-365-9435
Fax: 818-365-2788

Tegal Scientific Inc
125-J Mason Circle
Concord, CA 94510
Phone: 510-827-1054
Natl: 800-227-2012
Fax: 510-827-1189

Tekmar Co
PO Box 429576
Cincinnati, OH 45242-9576
Phone: 513-247-7000
Natl: 800-543-4461
Fax: 513-247-7050

Teltemp Corp
Box 5160
Fullerton, CA 92635
Phone: 714-879-2901
Fax: 714-870-8156

Teledyne Brown Engineering Environmental Services
50 Van Buren Ave,
PO Box 1235
Westwood, NJ 07675
Phone: 201-664-7070
Natl: 800-666-0222
Fax: 201-664-5586

Teledyne Brown Engineering Analytical Instruments
16830 Chestnut St
Industry, CA 91747
Phone: 818-961-9221
Fax: 818-961-2548

Telog Instruments Inc
830 Canning Parkway
Victor, NY 14564-8940
Phone: 716-742-3000
Fax: 716-742-3006

Tenco Hydro Inc
4620 Forest Ave
Brookfield, IL 60513-2594
Phone: 708-387-0700
Fax: 708-387-0732



Tenerex Corp
303 Laurel
Friendswood, TX 77546
Phone: 713-482-5801
Fax: 713-482-8317

Terra Consulting Group Inc
8900 Anselmo Lane
No. 222
Baton Rouge, LA 70810
Phone: 504-769-1141
Fax: 504-769-1724

Terra Universal Inc
700 N Harbor Blvd
Anaheim, CA 92802
Phone: 714-526-0100
Fax: 714-992-2179

Terracon Environmental Inc
16000 College Blvd
Lenexa, KS 66219
Phone: 913-599-6886
Natl: 800-593-7777
Fax: 913-599-3799

Testo Inc
230 Route 206
Flanders, NJ 07836
Phone: 201-252-1720
Natl: 800-227-0729
Fax: 201-252-1729
SEE AD ON PAGE 72

Testwell Craig Laboratories Inc
47 Hudson St Bldg B
Ossining, NY 10562
Phone: 914-944-2570
Natl: 800-444-9013
Fax: 914-941-4154

Texas State Technical College (TSTC)
3801 Campus Drive
Waco, TX 76705
Phone: 817-867-3438
Fax: 817-867-2973

Texas Workers' Compensation Insurance Fund
100 Congress Ave No. 300
Austin, TX 78701
Natl: 800-859-5995
Fax: 512-505-6292
Insurance
SEE AD ON PAGE 70, 98

Thel-Mar Co
134 W Fifth St
Lansdale, PA 19446
Phone: 215-362-2998
Natl: 800-322-9347
Fax: 215-362-2998

Therm Tech Inc
808 Russell Palmer Road
Kingwood, TX 77339
Phone: 713-359-7555
Natl: 800-659-8271
Fax: 713-359-7550

Thermoplastic Processes Inc
1268 Valley Road
Stirling, NJ 07980
Phone: 908-561-3000
Fax: 908-753-6749

Thermotron
291 Kollen Park Drive
Holland, MI 49423
Phone: 616-393-4580
Fax: 616-392-5643

3M Ceramic Fiber Products
3M Center Bldg 206-1W-11
St Paul, MN 55144-4379
Phone: 800-328-1687
Natl: 800-328-1687
Fax: 800-523-4379

3M Co (Performance Chemicals)
3M Center Bldg 223-6S-04
St Paul, MN 55144-1000
Phone: 612-733-0444
Natl: 800-360-6777
Fax: 612-736-7542

3M Filtration Products
3M Center Bldg 275-6E-08
St Paul, MN 55144-1000
Phone: 612-733-9781
Natl: 800-648-3550
Fax: 613-733-9525

3M Occupational Health & Environmental Safety Div
3M Center Bldg 275-6W-01,
PO Box 33275
St Paul, MN 55133-3275
Natl: 800-896-4223
Fax: 612-736-0930

Timco Manufacturing Inc
851 15th St
Prairie du Sac, WI 53578
Fax: 608-643-4275



Time Mark Corp
11440 E Pine St
Tulsa, OK 74116
Phone: 918-438-1220
Fax: 918-438-0025

Tnemec Co Inc
6800 Corporate Drive
Kansas City, MO 64120
Phone: 816-483-3400
Fax: 816-483-3969

Total Containment
A 130 North Drive
Oaks, PA 19456
Phone: 610-666-7777
Fax: 610-666-5321



Tracer Research Corp
3755 N Business Center Drive
Tucson, AZ 85705
Phone: 520-888-9400
Natl: 800-394-9929
Fax: 520-293-1306
SEE AD ON PAGE 41

Tracker Technologies Inc
3205 Lakewood Blvd
Long Beach, CA 90808
Phone: 310-496-4001
Natl: 800-338-3205
Fax: 310-496-4622

Tracom Inc
PO Box 1519
Roswell, GA 30077-1519
Phone: 770-664-6513
Fax: 770-664-6906

Tranport Law Research Inc
57 North St No. 404
Danbury, CT 06810
Phone: 203-830-4018
Fax: 203-830-4015

Transducer Research Inc
999 Chicago Ave
Naperville, IL 60540
Phone: 708-357-0004
Fax: 708-357-1055

Traverse Group, The
3772 Plaza Drive
Ann Arbor, MI 48108
Phone: 313-747-9300
Fax: 313-747-9229

Treatment Technologies
584 Poplar Road
Honey Brook, PA 19344
Phone: 610-273-2977
Natl: 800-733-7844
Fax: 610-286-6145

Triangle Laboratories Inc
801 Capitola Drive
Durham, NC 27713
Phone: 919-544-5729
Fax: 919-544-1356

Trinity Consultants Inc
12810 N Central Expressway
No. 1200
Dallas, TX 75243
Phone: 214-661-8100
Natl: 800-229-6655
Fax: 214-385-9203

Trisep Corp
93 S La Patera Lane
Goleta, CA 93111
Phone: 805-964-8003
Fax: 805-964-1235

Turner Designs Inc
845 W Maude Ave
Sunnyvale, CA 94086
Phone: 408-749-0994
Fax: 408-749-0998
Analytical Instruments,
Wastewater; Analytical
Instruments, Water; Field
Testing Instruments/Services;
Flow Instrumentation;
Groundwater Testing &
Monitoring Equipment;
Hydrocarbon Detectors;
Instrument Rental; Monitoring
Systems, Water; Oil/Water
Monitors; Process Control
Instrumentation; Leak
Detectors; Water Quality
Instrumentation; Stormwater
Monitoring
SEE AD ON PAGE 21, 83

Tylan General Inc
9577 Chesapeake Drive
San Diego, CA 92123-1304
Phone: 619-571-1222
Fax: 619-576-1703



Tymco Inc
PO Box 2368
Waco, TX 76703-2368
Phone: 817-799-5546
Natl: 800-258-9626
Fax: 817-799-2722



U S Best
PO Box 346
New Albany, IN 47151
Phone: 812-941-8867
Fax: 812-941-8982

U S Environmental Engineering Inc
1100 Northmeadow Parkway
No. 108
Roswell, GA 30076
Phone: 770-740-1000
Natl: 800-989-0200
Fax: 770-740-0700

U S Industrial Products Co Inc
13926 Equitable Road
Cerritos, CA 90703
Phone: 310-802-9688
Fax: 310-802-8518

ULTRA Scientific
250 Smith St
North Kingstown, RI 02852
Phone: 401-294-9400
Fax: 401-295-2330

Ultra-Research Inc
PO Box 307
Atwood, CA 92601
Phone: 714-779-0151
Fax: 714-779-7460

UltraTech Intl Inc
11711-2 Phillips Hwy
Jacksonville, FL 32256
Phone: 904-292-1611
Natl: 800-353-1611
Fax: 904-292-1325

Unidata America
17408 Bonnes Ferry Road
Lake Oswego, OR 97035
Phone: 503-697-3570
Fax: 503-697-3571



Unipure Environmental
1511 E Orangethorpe Ave
Fullerton, CA 92631
Phone: 714-447-5500
Natl: 800-323-8647
Fax: 714-447-5508



Unisorb Corp
PO Box 388
S Houston, TX 77587
Phone: 713-943-3753
Fax: 713-943-7313

United Air Specialists Inc
4440 Creek Road
Cincinnati, OH 45242
Phone: 513-891-0400
Natl: 800-992-4422
Fax: 513-891-4882

United McGill Corp
1 Mission Park,
PO Box 7
Groveport, OH 43125-0007
Phone: 614-836-9981
Fax: 614-836-9843

United Process Inc
 PO Box 545,
 279 Silver St
 Agawam, MA 01001
 Phone: 413-789-1770
 Natl: 800-569-1294
 Fax: 413-789-2248

United Sciences Inc
 5310 N Pioneer Road
 Gibsonia, PA 15044
 Phone: 412-443-8610
 Fax: 412-443-7180

United States Filter Corp
 4669 Shepherd Trail,
 PO Box 560
 Rockford, IL 61105-0560
 Phone: 815-877-3041
 Fax: 815-877-0172

**Univ of California
 Extension Ctr for
 Media & Independent**
 2000 Center St. No. 400
 Berkeley, CA 94704
 Phone: 510-642-4124
 Fax: 510-643-9271

Universal Engineering
 800 First Ave NW
 Cedar Rapids, IA 52405
 Phone: 319-365-0441
 Fax: 319-369-5440

**Universal Process
 Equipment Inc**
 PO Box 338
 Roosevelt, NJ 08555-0338
 Phone: 609-443-4545
 Fax: 609-259-0644

University of Findlay, The
 1000 N Main St
 Findlay, OH 45840
 Phone: 419-424-4572
 Natl: 800-521-1292
 Fax: 419-424-5303

**University of Illinois
 Institute of Labor
 & Indus Relat**
 504 E Armory Ave
 Champaign, IL 61820
 Phone: 217-333-0640
 Fax: 217-244-8396

Upright Inc
 10665 Kahlmeyer Drive
 St Louis, MO 63132
 Phone: 314-426-3336
 Natl: 800-248-7007
 Fax: 314-426-0145

Uvex Safety Inc
 10 Thurber Blvd
 Smithfield, RI 02917
 Phone: 401-232-1200
 Natl: 800-343-3411
 Fax: 401-232-1830

V

VICI Metronics Inc
 2991 Corvin Drive
 Santa Clara, CA 95051
 Phone: 408-737-0550
 Fax: 408-737-0346

VICI Valco Instruments Co Inc
 PO Box 55603
 Houston, TX 77255
 Phone: 713-688-9345
 Natl: 800-367-8424
 Fax: 713-688-3948



Vac-U-Max
 37 Rutgers St
 Belleville, NJ 07109
 Phone: 201-759-4600
 Natl: 800-289-8228
 Fax: 201-759-6449

Vaisala Inc
 100 Commerce Way
 Woburn, MA 01801-1068
 Phone: 617-933-4500
 Fax: 617-933-8029

**Vallen Safety
 Supply Co**
 13333 Northwest Freeway
 Houston, TX 77040
 Phone: 713-462-8700
 Natl: 800-372-3389
 Fax: 713-462-5145

Vamco Engineering Group
 3000 Langford Road
 Bldg 700
 Norcross, GA 80071
 Phone: 770-441-2729
 Fax: 770-246-9885

Van Oppen & Co
 1440 N Harbor Blvd No. 725
 Fullerton, CA 92635
 Phone: 714-447-3981

**Vanton Pump
 & Equipment Corp**
 201 Sweetland Ave
 Hillside, NJ 07205
 Phone: 908-688-4216
 Fax: 908-686-9314

**Vara Intl
 Div of Calgon Carbon Corp**
 1201 19th Place
 Vero Beach, FL 32962
 Phone: 407-567-1320
 Fax: 407-567-4108

Veeder-Root Co
 125 Powder Forest Drive
 Simsbury, CT 06070
 Phone: 203-651-2700
 Fax: 203-651-2719

Vibra Screw Inc
 755 Union Blvd
 Totowa, NJ 07511
 Phone: 201-256-7410
 Fax: 201-256-7567

Vista Information Solutions Inc
 5060 Shoreham Place No. 300
 San Diego, CA 92122
 Phone: 619-450-6100
 Natl: 800-733-7606
 Fax: 619-450-6195
SEE AD ON PAGE 8

Von Roll/WTI
 1250 St George St
 East Liverpool, OH 43920
 Phone: 216-385-7337
 Fax: 216-385-2160
SEE AD ON PAGE 48, 115

Vortex Co
 121 S Indian Hill Blvd
 Claremont, CA 91711
 Phone: 909-621-3843
 Fax: 909-624-7212

Vulcan Iron Works Inc
 1050 Mellon Bank Center
 Wilkes-Barre, PA 18701
 Phone: 717-822-2161
 Fax: 717-823-3568

**Vulcan Peroxidation
 Systems Inc**
 5151 E Broadway
 No. 600
 Tucson, AZ 85711
 Phone: 520-790-8383
 Natl: 800-552-8064
 Fax: 520-790-8008

W

W Canning Inc
 223 N Brockman
 Pasadena, TX 77506
 Phone: 713-472-5081
 Natl: 800-521-2589
 Fax: 713-472-2440



Waid & Associates
 14205 Burnet Road
 No. 500
 Austin, TX 78728
 Phone: 512-255-9999
 Fax: 512-255-8780

**Walk, Haydel
 & Associates Inc**
 600 Carondelet St
 New Orleans, LA 710130
 Phone: 504-586-8111
 Fax: 504-522-0554

**Walker Process
 Equipment
 Div of McNish Corp**
 840 N Russell Ave
 Aurora, IL 60506
 Phone: 708-892-7921
 Fax: 708-892-7951

**Walter Grossman &
 Assoc**
 4-59 Ivy Lane
 Fair Lawn, NJ 07410-1652
 Phone: 201-797-8223
 Fax: 201-797-0942

Warman Intl Inc
 PO Box 7610
 Madison, WI 53707-7610
 Phone: 608-221-2261
 Fax: 608-221-5810

**Warren Advanced
 Composites**
 82 Bridges Ave
 Warren, MA 01083
 Phone: 413-436-7711
 Fax: 413-436-5606

Warren Rupp Inc
 PO Box 1568,
 800 N Main St
 Mansfield, OH 44901
 Phone: 419-524-8388
 Fax: 419-522-7867

Waste-Tech Inc
 1931 Industrial Drive
 Libertyville, IL 60048
 Phone: 708-367-5150
 Fax: 708-367-1787

**Water Equipment
 Technologies Inc**
 832 Pike Beach
 W Palm Beach, FL 33411
 Phone: 407-684-6300
 Fax: 407-697-3342



Water Specialties Corp
 191 W Poplar Ave
 Porterville, CA 93257
 Phone: 209-784-3544
 Fax: 209-784-1787

Weather Metrics
 14645 W 95th St
 Lenexa, KS 06215
 Phone: 913-438-7666
 Natl: 800-869-6629
 Fax: 913-438-2666

Weather Network Inc
 568 Manzanita Ave No. 1
 Chico, CA 95926
 Phone: 916-893-0308
 Fax: 916-893-4517

Weatherly Inc
 1100 Spring St NW No. 800
 Atlanta, GA 30309
 Phone: 404-873-5030
 Natl: 800-992-7674
 Fax: 404-873-1303

Wedding & Associates Inc
 209 Chrisman Drive
 Fort Collins, CO 80524
 Phone: 970-221-0678
 Natl: 800-367-7610
 Fax: 970-221-0400

Welair Inc
 1349 Llewellyn Ave
 Norfolk, VA 23517-2266
 Phone: 804-626-0719
 Fax: 804-626-0719



Western Filter Co
 PO Box 16323
 Denver, CO 80216
 Phone: 303-288-2617
 Fax: 303-283-9328

**Western Water
 Consultants Inc**
 611 Skyline Road
 Laramie, WY 82070
 Phone: 307-742-0031
 Fax: 307-721-2913

**Westinghouse
 Motor Co**
 IH-35 & Westinghouse Road,
 PO Box 277
 Round Rock, TX 78681
 Phone: 512-244-5500
 Natl: 800-451-8798
 Fax: 512-255-4141

**Westport
 Environmental Systems**
 251 Fire Road
 Westport, MA 02790
 Phone: 508-636-8811
 Natl: 800-343-9411
 Fax: 508-636-2088

Wharton Environmental
 101 S Livingston Ave
 Livingston, NJ 07039
 Phone: 201-992-5775
 Natl: 800-221-2725
 Fax: 201-992-6660

Whatman Inc
 6 Just Road
 Fairfield, NJ 07004
 Phone: 201-882-9277
 Natl: 800-343-5853
 Fax: 201-882-5134

Whatman/Balston
 260 Neck Road
 Haverhill, MA 01835
 Natl: 800-343-4048
 Fax: 508-374-7070

**Wheaton Science
 Products**
 1501 10th St
 Millville, NJ 08332
 Phone: 609-825-1400
 Fax: 609-825-1368

**Wheelabrator
 Clean Air Systems Inc**
 441 Smithfield St
 Pittsburgh, PA 15222
 Phone: 412-562-7300
 Fax: 412-562-7617

**Wheelabrator
 Clean Water Inc - HPD Div**
 55 Shuman Blvd
 Naperville, IL 60563
 Phone: 708-357-7330
 Fax: 708-717-2247

**Wheelabrator
 Clean Water Inc - Memtek Div**
 28 Cook St
 Billerica, MA 01821
 Phone: 508-667-2828
 Natl: 800-527-0433
 Fax: 508-667-1731

**Wheelabrator
 Technologies Inc**
 Liberty Lane
 Hampton, NH 03842
 Phone: 603-929-3000
 Natl: 800-682-0026
 Fax: 603-929-3139

**Wheelabrator
 Water Technologies Inc
 Bio Gro Div**
 180 Admiral Cochrane Drive
 No. 305
 Annapolis, MD 21401
 Phone: 410-224-0022
 Fax: 410-224-0152

Wilkens-Anderson Co
 4525 W Division St
 Chicago, IL 60651
 Phone: 312-384-4433
 Fax: 312-384-6260

William J Narup & Co
 1955 Raymond Drive
 Northbrook, IL 60062
 Phone: 708-480-1903
 Fax: 708-480-1906

**Williams Environmental
 Services Inc**
 2075 West Park Place
 Stone Mountain, GA 30087
 Phone: 770-879-4107
 Natl: 800-247-4030
 Fax: 770-879-4831

**Wilson Safety
 Products**
 PO Box 622
 Reading, PA 19603-0622
 Phone: 610-376-6161
 Fax: 610-371-4515

Winsor & Jerauld

1525 Old Louisquisset Pike
Lincoln, RI 02865
Phone: 401-727-4480
Fax: 401-727-4483

Wisconsin Protective Coat

PO Box 8147
Green Bay, WI 54308-8147
Phone: 414-437-6561
Fax: 414-437-8083

Wixel Inc

7936 E Arapahoe Ct S-3200
Englewood, CO 80112
Phone: 303-796-0045
Natl: 800-685-5813
Fax: 303-796-0043

Wolfco Group Inc

7553 Clover Ave
Mentor, OH 44060-5206
Phone: 216-953-1115
Natl: 800-227-9653
Fax: 216-953-1116

Wolverine

(Massachusetts) Corp

1861 Nimitz Drive,
PO Box 521
De Pere, WI 54115
Phone: 414-336-5231
Natl: 800-862-6943
Fax: 414-336-5360

Wonder Makers Inc

PO Box 50209
Kalamazoo, MN 49005-0209
Phone: 616-382-4154
Fax: 616-382-4161

Worldwide

Technology Inc
445 Douglas Road E
Oldsmar, FL 34677-2907
Phone: 813-855-2443
Fax: 813-855-2655

Wyo-Ben Inc

PO Box 1979
Billings, MT 59103
Phone: 406-652-6351

Natl: 800-548-7055
Fax: 406-656-0748
Wyssmont Co Inc
PO Box 1397
Ft Lee, NJ 07024
Phone: 201-947-4600
Fax: 201-947-0324



Xchanger Inc

1401 South 7th St
Hopkins, MN 55343
Phone: 612-933-2559
Fax: 612-933-5647



YSI Inc

1725 Brannum Lane
Yellow Springs, OH 45387
Phone: 513-767-7241
Natl: 800-765-4974
Fax: 513-767-9353

Yamada Science

& Art Corp (YSA)
Route 4
Box 81-A
Santa Fe, NM 87501-9804
Phone: 505-989-7351
Fax: 505-989-7965



Zellweger

Analytics Inc
100 Park Ave
League City, TX 77573
Phone: 713-332-2484
Fax: 713-554-6795

Zero Enclosures

200 North 500 West
North Salt Lake, UT 84054
Phone: 801-298-5900
Fax: 801-292-9450

Ziamatic Corp

10 W College Ave,
PO Box 337

Yardley, PA 19067-0587

Phone: 215-493-3618
Natl: 800-711-3473
Fax: 215-493-1401

Zimmerman Industries Inc

196 Wabash Road
Ephrata, PA 17522
Phone: 717-733-6166
Fax: 717-733-1169

Zimpro Environmental Inc

301 West Military Road
Rothschild, WI 54474
Phone: 715-359-7211
Natl: 800-826-1476

Zurn Air Systems

211 Summit Parkway
Birmingham, AL 35209
Phone: 205-942-2211
Fax: 205-942-0004

COMPANY PROFILES



**CONFUSED ABOUT WHY?...
YOUR COMPANY'S NAME DOES NOT APPEAR IN THE
1996 ENVIRONMENTAL
PROTECTION BUYER'S GUIDE!?!**

To make sure your company is represented in the
1997 Environmental Protection Buyer's Guide,

fill out the coupon below so we can send you next year's questionnaire.

YES! We want to be listed in your 1996 Buyer's Guide. Add our name to your list to receive a FREE LISTING QUESTIONNAIRE and mail back to: **Environmental Protection**, P.O. Box 2573, Waco, TX 76702-2573, or phone (817) 776-9000, fax (817) 662-7075, Attn: Sourcebook Coordinator.

Contact Person _____

Company _____

Address _____

City _____ State _____ Zip _____

Phone _____ Fax _____



The

SuperEH&S™

disc is here!

For Windows®,
Windows 95®
& Macintosh®

FOLIO
INFOBASE

*The complete EH&S regulatory and
legal library on a single monthly CD-ROM.*

Now you can have all the updated federal & state EH&S information you'll need on one convenient disc. With this portable library, your research will be faster and easier than ever.

Only Counterpoint's **SuperEH&S** disc gives you fingertip access to complete federal and state EH&S regulations and statutes, and much more.

You'll find accurate easy-to-read tables and instant hyperlinked access to cross-referenced citations. Latest Folio™ search software makes this disc fully compatible for Windows, Win95 and Macintosh platforms. And it's fully networkable.

The single-disc solution.

Each SuperEH&S disc includes:

- Complete CFR for EPA, OSHA, DOT and relevant sections from other titles – updated from the daily Federal Register
- U.S. Code - annotated and updated EH&S statutes
- Complete daily Federal Register, latest month
- Federal Register history - five years of EPA, DOT and OSHA articles from 1990 to present
- The most current and comprehensive state regulations available for all 50 states (priced separately)

*A one-year subscription includes
12 monthly updates.*

With your SuperEH&S order, you'll get 12 comprehensive CDs with all software upgrades, documentation and toll-free technical support.

Compare the utility, ease-of-use and value of the SuperEH&S disc with any similar product. You'll see why Counterpoint sets the standard for electronic regulatory products.

We're so sure you'll be satisfied with the SuperEH&S disc, we offer a risk-free 30 day guarantee. Call 800-998-4515 today for more information.

SuperEH&S Disc Introductory Special Offer:

With your annual subscription order, we'll include a **FREE Panasonic portable CD-ROM player** for your



computer, a \$399 value (while supplies last). This SCSI CD-ROM player includes adaptor and cable, installation software, and AC adaptor. Call now to take advantage of this limited-time offer.

COUNTERPOINT
PUBLISHING

800-998-4515

84 Sherman Street, P.O. Box 928, Cambridge, MA 02140
<http://www.counterpoint.com>

All of Counterpoint's federal and state compliance products are available as individual titles or in any combination of titles you choose. Educational discounts are available. Counterpoint is FEDLINK listed.

SuperEH&S is a trademark of Counterpoint Publishing, a Thomson Legal Publishing company. All other trademarks are property of their respective owners.

Circle 114 on card.

HOT SPOTS

NEW! Resource Handbook puts CRUCIAL Information at your Fingertips!

**Get Environmental Information Quickly!
Be among the most prepared in your field.**

THE ENVIRONMENTAL CONSULTANTS' RESOURCE HANDBOOK (California Edition) contains:

Information & Data Sources

Regulatory information sources, geology, hydrology, topography, and remote sensing data

Federal, State and Local Regulations

List of Acronyms

Laboratory Methods

Chemical Properties & Regulatory Goals

Treatment Technologies

Environmental Agency/Regulatory Phone Book



Order from this ad by February 28, 1996 and we pay shipping! No risk 30-day money back guarantee. Send for free brochure or send check or money order for \$91.59 (tax included) per handbook to EnviroConcepts, Inc., P.O. Box 3407, Costa Mesa, CA 92628. Phone (714) 434-9502. Please enclose a copy of this ad with your order.

Shredders



- Reduce
- Recycle
- Recover

SHRED-TECH manufactures shredders and systems for:

- Industrial Waste
- Hazardous Waste
- Tires & MSW
- Plastics & Paper
- Product Recovery

Call SHRED-TECH at 1-800-465-3214

Environmental responsibility can be profitable

Announcing...

**ELDRIGE COMPANIES
RESIDUAL WASTE
OIL/WATER
RECLAMATION
FACILITY**

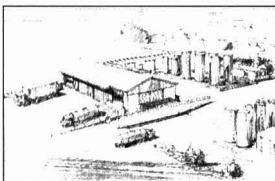

Consider the following benefits:

- Competitive pricing • Reduced Liability Exposure
- Innovative Disposal Method • D.O.T. Approved Transportation Fleet
- 24 Hour Emergency Service 7 Days a Week
- On-Site Laboratory Services

Our facility's objective is to recover non-hazardous oil from contaminated residual waste in liquid and high solid phases. (Heavy Ends)

Permit Submitted, May 1995 • Opening 1996

898 Fernhill Rd., West Chester, PA 19380
800-220-2052 • FAX 610-430-6948

Challenge-Proof Environmental Sampling Series

Fundamental Principles & Techniques

ENVIRONMENTAL SAMPLING VIDEO

Environmental Sampling...an important aspect of environmental compliance that many companies take for granted. To help ensure that each environmental sample will always withstand the toughest scrutiny, Plexus Environmental Group is pleased to offer a ground-breaking video tape:

Challenge-Proof Environmental Sampling: Fundamental Principles and Techniques

In just 26 fast-paced minutes, each member of your environmental compliance team will review basic environmental sampling protocols; from preparation, to sample collection, to delivery at the lab. This program introduces important sampling concepts to novices and serves as a refresher for seasoned professionals.

Plexus Environmental Group
4900 Seminary Road, Suite 440 • Alexandria, Virginia 22311
(703) 931-3333 • FAX (703) 931-1542

UNIMAX

LARGE WALK-IN FUME HOODS

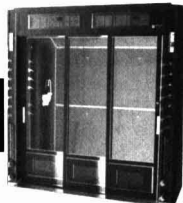

• Durable advanced composite chemical resistant construction (No Steel Framing)

- Exhaust, filtration systems meet OSHA & EPA clean air requirements
- Services, accessories to suit your specifications
- Special Doors, floors can be custom engineered
- Custom built in sizes up to 16'Wx8'Dx12'H, complete with services to suit.

★ **New HAZMAX Safe Work Enclosure**

A large hazardous containment work area similar to the Unimax, except with recessed containment basin to control accidental spills. The answer to OSHA safe designated work areas!

For prompt service call (816) 796-2900

111 North Powell, Independence, MO, U.S.A. 64056



**The University of New Mexico
School of Engineering**
Professional Engineering Development
Training Center Presents

TRANSPORTATION of HAZARDOUS MATERIALS Workshop

MARCH 12-14, 1996

Probabilistic Risk/Safety Analysis

MAY 22-24, 1996

For information call
(800) 453-3940 or (505) 277-5875

THE (CLASSIFIEDS)

RECRUITMENT



Opportunities For All Environmental Professionals

- Profit Center Management
 - Senior Technical Positions
 - Project Management
 - Consulting and Industry
- Air Quality • Water/Wastewater • Solid Waste • Hazardous Waste
Groundwater • Remediation • Treatment Systems Design

REPRESENTATIVE CLIENTS:

OHM • Dames & Moore • Foster Wheeler • ICF Kaiser • ESE
Bechtel • Bristol Meyers • Metcalf & Eddy • Brown & Root • ASI
Amoco • Exxon Chemical • Brown & Caldwell • HDR • Merck
Harding Lawson • EMCON • Rust • Kodak • Shering-Plough
REMAC • CDM • Archer Daniels • Hoechst Celanese • ATEC

Coast to Coast Contacts and Network, Second to None!!!

Brian MacLennan, C.P.C., President / Angela Swope, VP Administration
21514 Gulfstar Court Davidson, NC 28036
■ Phone: 704-896-3336 ■ Fax: 704-896-3337

SAFETY/ENVIRONMENTAL \$25,000 - \$110,000

NATIONWIDE SPECIALISTS - ALL DISCIPLINES
Safety & Health, Ind Hygienists, Health Physicists,
Air Quality, Ergonomics, Environmental

ELIAS ASSOCIATES INC.

P.O. Box 396 Dept. OH • East Brunswick, NJ 08816
Gary Elias 908-390-4600 • FAX 908-390-9769

SUNBELT OPPORTUNITIES

\$28,000 to \$78,000

Immediate openings nationwide in virtually all
Environmental/Safety & Health related disciplines.

Contact: **Kimberly Cranford, C.P.C.**,

PROFESSIONAL PERSONNEL ASSOCIATES, INC.
7520 E. Independence Blvd., #160 - Charlotte, N.C. 28227
(704) 532-2599 (704) 536-8192 FAX

CAREER OPPORTUNITIES NATIONWIDE

- H & S Mgrs
- Fire Prot
- Loss Control
- Risk Mgmt
- I.H.
- Haz. Control

When you care enough about your career to select the very
FINEST positions with operating Co's RESUME TO: Peter
Ansara, c/o ABF, PO Box 239, West Spld., MA 01090
Tel 413-733-0791 Fax 413-731-1486

Strictly confidential/ Never a Fee.

ENVIRONMENTAL PROFESSIONAL SOUGHT FOR BIOREMEDIATION FIELD WORK IN EUROPE

A major European environmental management
firm is expanding its in-house bioremediation
capability. Seeking experienced (minimum 3 to 5
years) personnel familiar with operating and man-
aging field remediation projects to oversee applica-
tion of bioremediation engineering methods.
Position will supervise site remediation jobs in
Western Europe for 1-3 year period. Experience
with field bioremediation projects and an
advanced degree preferred. Interested parties
should send resume and salary requirements to:

Env. Protection, Blind Box #286
P.O. Box 2573, Waco, TX 76702-2573

Manufacturer's Reps WANTED

George Fischer Inc. is seeking manufac-
turer's reps experienced with environmental
gas processing equipment. Territories avail-
able throughout the U.S.

Contact Harold Sipe at: 800-854-4090 or
send inquiry to:

George Fischer Inc
2882 Dow Avenue, Tustin, CA 92680

Environment

ENVIRONMENTAL CHEMIST

Master of Science Degree in Chemistry,
Hydrology or Environmental Science. Working
knowledge of computer languages (Fortran,
quickbasic) and Database Management, water
quality evaluation and pollution hydrology in
environmental system, OS/2 operating
system and instrument troubleshooting. Con-
duct analysis on trace metal in water, waste-
water, blood, hair and urine using ICP (Inductively Coupled Plasma) and ICP-MS. Conduct tests for
nitrate, nitrite, sulfate, TDS, fluoride and
bacteria in water and wastewater. Quality
control/quality assurance throughout the lab.
Experimental data reduction and interpretation
using computer software and database. Con-
tribute to data report preparation. 40 hr wk.,
salary \$30,160.00 per year. Application by
resume ONLY to Colorado Department of
Labor & Employment, ATTN: Jim Shimada,
Employment Programs, Tower 2, Suite 400,
1515 Arapahoe Street, Denver, Colorado
80202, and refer to Order Number
CO4455501. NO PHONE CALLS PLEASE.
Must have proof of legal authority to work in
the U.S.

OPPORTUNITIES

Positions available for Industrial Hygienists,
Safety/Environmental & Toxicology Professionals.
Please send resume including current/desired
salary & geo. preferences to:

Greg Downs
Executive Recruiters Agency, Inc.
P.O. Box 21810, Little Rock, AR 72221-1810
(501) 224-7000; FAX: (501) 224-8534

ENVIRONMENTAL SPECIALIST

Responsibilities include regulatory tracking,
interpreting, and reporting; auditing; and
developing environmental procedures and plans.

A.B.S. degree in Environmental Engineering,
Chemistry or other related sciences; five years
experience in environmental work (preferably
in chemical manufacturing); superior reading,
technical writing, verbal communication skills;
and use of computer software applications are
required for this position.

Qualified candidates should mail or fax
(708) 298-3642 resume to **VELSICOL
CHEMICAL CORP.**
Attn: Human Resources-EPM,
10400 W. Higgins Road #660,
Rosemont, IL 60018

E.O.E. M/F/D/V

PRODUCTS & SERVICES

Dynatrol® The Best Available!

- ACCURATE measurement of density, specific gravity, % solids and % concentration
- AT PROCESS CONDITIONS
- For ACIDS, CAUSTICS, SLUDGES, PETROLEUM, PAINTS, COATINGS, ADHESIVES, SYRUPS, SAUCES, EMULSIONS, BEVERAGES, EVAPORATOR BOTTOMS, LIQUIDS, SLURRIES, etc.



Automation Products, Inc.
3030 Max Roy Street, Houston, Texas 77008-9981 USA
Fax 713-869-7332 Phone 800-231-2062

Biosolids Management

- Land Application • BIP • In Situ Alkaline Stabilization • 30% Composting
- Drying and Pelletizing

Wheelabrator Clean Water Systems Inc.

14000 North Loop West, Houston, Texas 77040
Phone 281-461-1000
Wheelabrator Division
Automation Products, Inc.

Get BIG Results

ENVIRONMENTAL CONSULTING SERVICES

ENVIRONMENTAL ASSESSMENT / IMPACT STATEMENT

AIR POLLUTION MODELING
Permits Risk Assessment Siting

METEOROLOGY
Historical Real Time Forecast

SPECIAL STUDIES AND FORENSICS
Meteorology Climatology Hydrology

Ph.D. And Certified Consulting Meteorologist On Staff

STRIP CHART DIGITIZING

DATA ANALYZING DATA PROCESSING

CUSTOM FORMAT ON TAPE,FLOPPY AND HARD COPY

STRIP CHART FILL-IN OF LOST LOGGER DATA

QUALITY ASSURANCE COMPARISON CHECKS

TIME AVERAGING OR DISCREET POINTS

DATA BASE MANAGEMENT

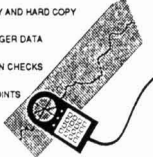

AIR SCIENCE CONSULTANTS, INC.

347 Prestley Rd. Bridgeville, PA 15017 (412) 221-6000

USED EQUIPMENT FOR SALE

(we also buy and trade)

- + Soil Treatment Equipment
- + Radial Stacking Conveyors
- + Thermal Oxidizers
- + SYE Equipment
- + PID's/FID's
- + Drill Rigs

and much more...

Alan Ross Machinery Corp.
3240 Commercial Ave
Northbrook (Chicago) IL 60062

☎ 708 480 8900



ACTIVATED CARBON ADSORBERS

The Carbon Activated liquid and Vapor phase Adsorbers contain specially formulated grades of high Active Carbon with excellent capabilities. Change-out services also available. large inventory of all grades of Coconut Shell and Coal Base Activated Carbon available for immediate shipment.

Carbon Activated

1662 West 139th Street
Gardena, CA 90249
(310) 323-8132

**ASBESTOS ANALYSIS
LEAD ANALYSIS**
SINCE 1981



NY • NJ • CA • GA • MI • TX • NC
(800) 220-3675



**Corporate
Environment Ltd.**
Executive Search

*Specializing in Industrial, Air, Water,
Wastewater, Solid Waste, HazMat
& Chemical Process Markets*

P.O. Box 798, Crystal Lake, IL 60039-0798
(815) 455-6070 • Fax: (815) 455-0124

THE LEADING PROVIDER OF
COMPLETE, INTEGRATED
ENVIRONMENTAL SERVICES
IN NORTH AMERICA

Clayton
ENVIRONMENTAL
CONSULTANTS

- ▼ Environmental Management
- ▼ Environmental Health
- ▼ Analytical Laboratory
- ▼ Risk Assessments
- ▼ Litigation Support

For more information, please call your nearest Clayton office.

Detroit	New York	Atlanta	San Francisco
810-344-1770	908-225-6040	404-499-7500	510-426-2000
Los Angeles	Honolulu	Minneapolis	Cleveland
714-229-4806	808-531-6708	612-834-0112	216-686-5100

**ADVANCED OIL/WATER
SEPARATION TECHNOLOGY**

HYDRASEP™
ADVANCED OIL/WATER SEPARATOR

*The Separator that
separates us from the rest.*

Call GNESYS, INC. @ **1-800-646-5439**
FAX (901) 744-6093, P.O. Box 14465,
Memphis, TN 38114

**Hydrocarbon Environmental
Recovery Systems**

- ▶ Microbial Products
- ▶ Custom & Portable Spill Kits
- ▶ Spill Response Products
- ▶ Oily Water Filtration Units
- ▶ Soil & Water Treatment



For Additional Information Call:
(210) 497-8980 Fax: (210) 497-4227
or write
P.O. Box 701275, San Antonio, TX 78270

**Classified Ads
Get Results**

**GLOBAL TELESIS
CORPORATION**

"The waste to energy people"

Mr. E.B. Elliott - President

1440 OAKLAND BLVD., SUITE 11
WALNUT CREEK, CALIFORNIA 94596
TEL (510) 210-1133 • FAX (510) 210-1139

**ALL TERRAIN
MOBILITY**



MATTRACKS OFF ROAD TRACK CONVERSION
IS THE SOLUTION FOR MAXIMUM MOBILITY IN
ALL ADVERSE TERRAIN CONDITIONS
MUD • SNOW • SAND • SWAMP

IDEAL FOR USE AT

- Remediation Sites
- Soil Sampling/Testing
- Land Fills
- Engineering and Surveying Sites

CAN BE MOUNTED ON ALL AMERICAN AND MOST FOREIGN
MAKES OF OFF-ROAD 4-WHEEL DRIVE VEHICLES.

FOR INFORMATION AND VIDEO PRESENTATION CALL:

218-528-4828

MATTRACK WILL GET YOU
TO THE JOB



**DO YOU NEED
REPAIRS?**

Parts, Machines
New & Used

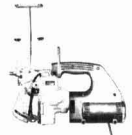

**J&H Machine
Co., Inc.**

specializing in
repairing U.S. Model #2200 B. Used
for sewing GEO Textile Material.

FREE Estimates 215-947-0930
First Rate Service, Quick Turn Around

**BIO-SYSTEMS
CORPORATION**

1-800-232-BUGS

ISO 9002 Certified Manufacturer



Bio-Solids Management

- Dredge
- Stabilization Process
- Biosolids Transportations
- Digester and Lagoon Cleaning
- Biosolids Application, wet/dry
- Turnkey Biosolids Management

Nation Wide Service
1-800-798-4205 Hudson, IA



Fluidized Bed Ash

An Environmentally & Economically Proven Stabilization Agent

Truck • Barge • Rail

Brazil Creek Minerals, Inc.
P.O. Box 10530 • Ft. Smith, Arkansas 72917
(501) 646-5418 • Fax (501) 646-3220



Western Technical Services[®] CAD Engineering Group

Lead/Asbestos Survey Data Collection
Integrated with AutoCAD
Raster to Vector Conversions
Over 150,000 Facilities to Date
DoD and Municipal Experience
Excellent References
Proven Cost Savings

Productive...Precise...Profitable

303 Lennon Lane, Suite 100
Walnut Creek, CA 94598
Tel: 510-988-8022 Fax: 510-939-6306

SOLID WASTE HANDLING EQUIPMENT



- Knuckle boom loaders
- Specialized attachments

For details:

USA : ROTOBEC USA INC.
Tel: (603) 444-2103

ROTOBEC-WEST USA INC.
Tel: (206) 357-6480

CANADA : ROTOBEC INC.-HEAD OFFICE
Tel: (418) 383-3002



ROTOBEC CANADA WEST INC.
Tel: (204) 326-1403

rotobec

EcoSense, Inc.

ENVIRONMENTAL COST CONTROL SERVICES



COST ANALYSIS
CONTRACTS MANAGEMENT
SYSTEMS REVIEWS

Savings identified on commission basis
Phone: 802-235-9300

DEWATERING EQUIPMENT

call 1-800-307-2189



Belt Filter Presses
Belt Thickeners
Screens
Screw Presses
Free Lab Testing

FRONTIER TECHNOLOGY, INC. fax: 616-673-9629



MOUNT SOPRIS

Instrument Company

Geophysical Logging Systems • Components • Software

17301 W. Collax Suite 255 • Golden, Colorado
(303) 279-3211 • FAX (303) 279-2730

MERCURY

MERCURY SPILL & SITE REMEDIATION
EMERGENCY RESPONSE TEAMS
MERCURY CONSULTANTS

1-800-8-MERCURY

Customized for remediation and wastewater treatment



While no single solution is right for every job, our flexible IBM/PC compatible smart RTU's can fulfill your unique needs. Features the functionality of a communications controller, a PLC and a Data Logger. Internal telephone and radio modems, dial-up on demand and direct dial-out to FAX and pager, expandable analog and digital I/O. Tell us your problems and we'll build a system to solve them.



NBT 
NOTA BENE TECHNOLOGY, INC.
7600 West 27th St. Suite 214
St Louis Park, MN 55426
Phone: 612-928-8872
FAX: 612-928-8874

AE ADVANCED ENGINEERING

Scientific and Engineering Instrumentation for Research and Industry

P.O. Box 93051, Milwaukee, WI 53203
414-223-4604 • FAX 414-223-4602

SOFTWARE

Desperately Seeking Software?

Our special reports and newsletter will help you find the right software for:

- MSDS Management
- Air Quality Data Management
- Environmental Regulations Access
- Environmental Program Management



DONLEY TECHNOLOGY

For free information and prices:
Call (804) 224-9427

Environmental Software Reports since 1988 *Guaranteed*

TRY A HOT SPOT AD!

Sample Labeler™

Software to print
container labels for
environmental samples

800-375-0702

Eventide Software Company

System Requirements

Hands tired of writing labels
Interest In Improved QA/QC
DOS-Compatible Computer
Dot matrix or Laser Printer

MIRS: the Integrated Compliance Software Choice

Modules for EPA-approved Form R, SARA, MSDS management, Air, Water, Waste, Inventory, Permit, Hazcom, State/Local, and more.



A V Systems, Inc.
(313) 973-3000

MSDS MANAGER

Best Way To Manage MSDS's.
Optional 75,000+ MSDS CD-ROM.

New WINDOWS/DOS Versions

CALL/FAX: (612) 541-9998
Programming Technology

SITE-ASSESSMENT™ Software

The Original ESA Phase I reports in minutes using our *Runs in Windows* newly improved expert text!

Assemble reports by picking sections of *ASTM-compatible* text from pop-up lists.

Our checklists guide your process.

Customize our text, import yours, & edit reports in *your own* word-processor

Box 3846 Indialantic, FL 32903
(800) 365-3962

FOR RENT

800-4-HNU-RENT



Specializing in Hnu PID Rental
Also: OVAs & LELs & More. . .

Offices Located in
New York & New Jersey
800-446-8736

ENVIRONMENTAL
RENTAL, INC.

FOR SALE

PETRO TITE — Tank Testing System

3 years old, like new, includes DTS 2000 sensor box (capable of handling four probes), self-leveling standpipe, termistor probe, API conversion kit

315-963-4378

FOR SALE

HES REGENERATIVE THERMAL OXIDIZING SYSTEM

900,000 SCFM Capacity
700 HP Blower
95% Thermal Efficiency
95% Destruction Efficiency
7 Chamber
Footprint 30' x 78'

Located At Sterling Heights, MI

For More Information Contact...

WARREN BRINEGAR
800-323-0041
410-821-3724
Fax: 410-825-2610

SURPLUS SALE

3300, MSA 466204 Mercury Chlorine
Respirator Cartridges, \$1 ea.
1, Mandiggers 2 Barrel Hyd Fork Lift
Attachment, \$1500

Call Joe Lukas 610-828-3500 ext. 118

FOR LEASE

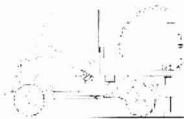

Your One Stop Probe Shop!

4WD truck mounted units, Kawasaki Mules, 2 size skid mounted units. All genuine late model Geoprobe. Tools, training, equipment, and delivery available. Affordable daily, weekly, and monthly rates. Lease/Purchase option for all units. Best quality. Units usually in stock for instant availability

Call Mac Christy at Probe Lease
1-800-645-2009

A terrible thing happens
when you don't advertise...

NOTHING

CONFERENCES

THE 8TH ANNUAL
NEW ENGLAND
ENVIRONMENTAL



EXPO '96

SHAPING THE FUTURE OF
THE ENVIRONMENT

MAY 7, 8 & 9, 1996
WORLD TRADE CENTER, BOSTON

FOR INFORMATION CALL
1-800-543-5259

INSURANCE BROKERAGE

*It's A Jungle
Out There!*

Even if it Glows
Blows - or Grows
We Will Protect You

SPEARE & COMPANY
Insurance Agents & Brokers

- Workers' Compensation
- Environmental Liability
- Commercial General Liability
- Automobile Fleet Insurance
- Bid Bonds & Performance Bonds
- Closure & Post-Closure

Contact:

Bob A. Borisoff

Phone: (310) 914-9300

Fax: (310) 914-9398

50 Years of Experience in Insurance and Bonds

SALES LEADS

Attention:
**Hazardous Waste
 Brokers & Equipment
 Manufacturers**

Waste Generator
 Sales Leads!
Only \$450

Includes: waste volumes, types,
 contacts, addresses,
 phone #s, SIC codes.

Choose between 2 states
 on CD-ROM or 2000 profiles
 in ACT! or dBase IV format.

Environmental Data Services
 call (800) 727-4496

HAZMAT TRAINING

Convenient NYC Location

Hazmat Supervisor
 Hazmat Refresher
 40 HR. Hazwoper
 Confined Space

American Hazmat Training Inst.
 545 8th Ave • NYC, NY 10018

1-212-868-9699

Call for schedule of courses.

A.H.T.I. Develops OSHA Written Hazcom
 Manuals, Respiratory Protection Plans,
 Site Safety and Health Plans.

NEW ENVIRONMENT, INC.

40-HOUR
HAZWOPER
 TRAINING



\$375



RUSH SERVICE
 NIOSH POCKET GUIDES \$13.00

800-732-3073

Call for Information



PRE FAB HAZMAT BLDGS



Turn-Key Haz-Mat Bldgs.

Up to 480 sq. ft. Meets all Fire, EPA, OSHA,
 Bldg. and Fire Codes.

FREE Catalog, Code Compliance Guide,
 and Specification Guide.

Haz-Mat Containment Corporation

Fax (510) 210-1054 • Tel (800) 943-6510

PROFESSIONAL DIRECTORY

*Action Environmental
 Service Corp.*

Registered Environmental Professionals

- Waste Disposal
- Water • Soil • Air • Assessments
- Bioremediation • Wastewater
 Treatment • Wetlands • Tanks

501 Silverside Rd., Wilmington, DE 19809

(302) 798-3100

24 Hour Message Center (302) 798-3000

(201) 992-0077

ENVIRO-ASSIST, INC.
*Environmental and
 Regulatory Assistance*

Stuart B. Cooper
 P.O. Box 2155
 Livingston, NJ 07039

CONTINUING EDUCATION

HAZWOPER TRAINING

- 40 Hour HAZWOPER - \$300.00
- 8-Hour Refresher - \$150.00
- Confined Space ■ Office Ergonomic
- Taught on site w/min. class size

For Information call **1-800-399-0420**

Environmental Resources Training Group Inc.
 "Meeting Your Environmental Training Needs"



Mid South Training Institute

(Environmental, Safety, Transportation)

Hazardous Waste, RCRA
 Environmental Audits
 Environmental Management
 Chemical Accidental Release
 Storm Water Discharge
 Others



HAZWOPER
 Confined Space Entry
 Lockout/Tagout
 Respiratory Protection
 Process Safety Management
 First Aid/CPR
 Bloodborne Pathogens
 Noise
 Hazard Communications
 All OSHA Programs



HM 126/181
 Commercial Drivers
 Chemical Transportation
 Others



Call our offices for consulting services information

2741 SOUTH NONCONAH
 BOULEVARD, SUITE 230
 MEMPHIS, TENNESSEE 38122 • (901) 345-5909

UNIVERSITY DEGREES!

Economical home study for Bachelor's, Master's,
 Doctorate, licensed by the California State Council for
 Private Postsecondary and Vocational Education.
 Prestigious faculty counsels for independent, individu-
 alized, at-a-distance education. Free information:
 Richard Crews, M.D. (Harvard), President, *Columbia
 Pacific University*, Dept. 3H98 1415 Third St., San
 Rafael, CA 94901; 800-552-5522 or 415-459-1650.

Upcoming
EPA Conferences
 for 1996

Invitation and CALL FOR PAPERS

"Bioremediation Treatment
 Technologies for Innovative
 Clean-up of Hazardous and
 Toxic Waste Sites"

Subsurface Soils & In Situ Aquifers Feb. 16;
 Pits, Lagoons & Chlorinated Solvents July 12;
 Mixed Waste & Modeling Performance
 Prediction Sept. 27.

- Free and Open to the Public •
- T-VI Board Room, SW Corner of
 Coal and University Avenues

Hosted by
**EPA Western Region Hazardous Substance
 Research Center & Albuquerque Technical
 Vocational Institute Environmental
 Technology Program**

for latest schedule information,
 please call Mr. Barry King at
 (505) 224-3764; FAX 224-3781
 E-Mail Address: bking@TVIcc.mm.us



Portable Sludge Dewatering Services
 • Pressure Filtration • Belt Filter Press • Centrifuge
 • Sludge Dryer • Dredging • Equipment Rentals

J.D. Meagher 
 Specialists in Sludge Handling

P.O. Box 752 ■ Westboro, MA 01581 ■ 508 396-9606

HIGH QUALITY FLEXIBLE GEOMEMBRANE LINERS
 PVC, PVC-OR, CPE, OGR & DYNAPRENE™
 UNSUPPORTED & SCRIM REINFORCED
 (800) 344-6080 or (908) 302-4257 FAX (908) 302-4220
 200 Cottontail Lane, Somerset, NJ 08873

HPG
 International, Inc.

Safe-T-Tank
 ABOVE GROUND DOUBLE CONTAINMENT

1-800-536-8910

PIT HOG 
PUMPS WASTE
 LWT Manufactures and leases manned or remote controlled lagoon dredges and pumps. Pumping systems move sludge, sand, silt, residuals and debris from lagoons, tanks, vessels and digesters.

Contract dredging also available.

LWT  **LIQUID WASTE TECHNOLOGY**
 Box 250,422 Main St, Somerset, WI 54025
Call Toll Free 1-800-243-1406

CONTAINER BAG LINERS



Leak Protection for Roll-Offs Dump Trailers and Railroad Cars

PACKAGING RESEARCH & DESIGN CORP.
 P. O. Box 678, Madison, Mississippi 39130-0678
TOLL FREE 1-800-833-9364

EARN YOUR COLLEGE DEGREE AT HOME

- B.S. & M.B.A. in Business
- B.S. in Environmental Studies
- M.S. in Environmental Management
- Approved for tuition reimbursement by major companies.

For a free catalogue call **1-800-767-CHAD.**

CHADWICK UNIVERSITY
 ACCREDITED MEMBER
 World Association of Universities & Colleges

 **ENVIRONMENTAL EDUCATION ENTERPRISES**

Presenting 60 Advanced Technical Short Courses Annually

HYDROGEOLOGY, MICROBIOLOGY, AIR, GEOCHEMISTRY, GEOPHYSICS, RISK, GIS, REMEDIATION, COMPUTER MODELING, MATHEMATICS, STATISTICS AND MORE

- Special Government/Student Rates
- 2 Scholarships per course
- Continuing Education Credits
- \$100.00 Future use Rebate

For additional information contact Dr. Jay Lehr
 1-800-792-0005 or FAX 614-792-0006
 E, 2764 Sawbury Boulevard
 Columbus, OH 43235

Raising Education to a Higher Power for the Environment

MATERIAL SAFETY DATA SHEET PREPARATION SERVICES

Are you looking for a resource to prepare your Material Safety Data Sheets? We can help! Chemical Safety Associates, Inc. has been preparing Material Safety Data Sheets since 1984. CSA can review your current MSDS for accuracy and compliance with Federal and State Specific requirements, or prepare your MSDS from scratch.

- Fast Accurate Service
- MSDS Prepared to New ANSI Standard
- MSDS Prepared to Comply with Canadian Whmis Regulations
- MSDS Prepared in English, Spanish, French and Other Languages

Call or write us today for details on how we can assist you!

CHEMICAL SAFETY ASSOCIATES, INC.
 9163 Chesapeake Drive
 San Diego, CA 92123-1002

 **619/565-0302** 

Circle 180 on card.

Enviro-Bac™2000
 Controls Odors, Digests Sludge
 Reduces BOD, TSS, FOG & NH3
 "We'll Guarantee It!"

Greer Environmental Services, Inc.
800-742-0553

SPECIALISTS IN:

INDOOR AIR QUALITY

- Testing for Building Related Disease
- Inspection and Testing of HVAC Systems
- Employee Complaints
- Testing for Chemicals, Molds, Bacteria, Asbestos
- Rapid Response-Nationwide

ATLANTIC ENVIRONMENTAL INC.
 2 E. BLACKWELL ST. DOVER, NJ 07801
 201-366-4660
 REGIONAL OFFICES: ATLANTA • CHICAGO
 1-800-344-4414

AMERICAN COLLOID #AC750/F2
 Wastewater Treatment Machine

- 525 Gallon/Hr Max. Throughout Cap.
- 200 Gallon Reaction Tank Capacity
- Control Console
- Manual Valve Controls
- Non-Corrosive Turbine
- 1 HP Turbine Mixer
- 1/3 HP Band Filter
- 1989
- FCA, Toledo, OH - \$17,500

Contact Dan Wehrle
WELDON F. STUMP & COMPANY, INC.
 tel: 419-243-6221 • fax: 419-243-7277

IATL
 International Asbestos Testing Laboratories

ASBESTOS ANALYTICAL SERVICES

- Complete In-House Facilities
- PCM, PLM and TEM
- Air, Bulk, Dust and Water Samples
- NVLAP and NY-ELAP Accredited

LEAD ANALYTICAL SERVICES

- Air, Paint, Soil, Dust and Water
- Flame and Graphite Furnace AAS
- AIHA - ELPAT Participants

IATL is an AIHA Accredited Industrial Hygiene Laboratory

CALL FOR PRICE QUOTES AND INFORMATION:
(609) 231-9449

16000 Horizon Way, Unit 100
 Mt. Laurel, NJ 08054

DAMES & MOORE

INTEGRATED Environmental & Earth Sciences

*Planning
 Engineering & Design
 Construction Management
 Waste Management*

OFFICES WORLDWIDE
 213 683 1560

HDR Engineering, Inc.
 Wastewater/Storm Water/Water Reuse
 Industrial Wastewater and Air Quality
 NPDES Permits
 Environmental
 Solid Waste Management
 Telephone: 402 399-1000

INSTRUMENT RENTAL

- Gas Detectors (CO, H₂S, LEL, C02, O₂, Hg...)
- PID/FID Detectors
- Aerosol/EMF/Noise/Velocitv Equipment
- Confined Space Entry Equipment
- Air Sampling/IH Equipment

Daily, Weekly, and Monthly Rates Available



ASC PROFESSIONALS

CALL FOR
FREE CATALOG

1-800-327-4260



One Stop Bioremediation

- BIO PRODUCTS - Bio-stimulators & nutrients
 - BIO EQUIPMENT - Bio-Chisel™ aerates & injects
 - BIO SOFTWARE - Project management software
 - BIO SCHOOL - Classroom and field training
 - SUBCONTRACTING - Extensive field experience
- For a complete Bioremediation Guide, call us at (210)426-3011 or FAX (210)426-2288.



Medina Bioremediation Division, Hondo, TX

LEGGETTE, BRASHEARS & GRAHAM, INC.

Professional Ground-Water and Environmental Services

Water Supply • Contamination • Modeling
Dewatering Permitting

Trumbull, CT
(203) 452-3100



Offices Nationwide
EST. 1944

TRAINING



A Services & Technology Company

- HAZWOPER training, in full compliance with 29 CFR 1910.120
- OHST Examination preparation
- HazMat Transportation training, as required by 49 CFR 172, subpart H

On-site or open enrollment

1-800-338-4487

Environmental PROTECTION

Fact

*Environmental Protection magazine
reaches the professionals responsible
for pollution control.*

Air	52,126
Water	63,221
Solid Waste	46,488
Industrial Hygiene	29,645
Toxic & Hazardous Materials	55,730

SECONDARY CONTAINMENT

SPILL KING

FEATURES:

- Removable deck (by forklift) for easy access and cleaning
- Chemical & corrosion resistant
- Recessed rings on deck pallet for secure drum storage
- One-piece molded sump construction
- Four-way entry for forklift
- Free Weather Shield provided with each unit



**SAFE ENVIRONMENTAL
STORAGE CORP.**

180 Devon Ave. • P.O. Box 36 • Bensenville, IL 60106
PHONE (800) 593-SAFE (708) 595-0666



Low-Cost Tanks Engineered To Solve Your Containment Problems

Modular, bolted-tanks in round, rectangular and special shapes, feature quick, low-cost installation. Rentals available.

(800) 245-6964

ModuTank Inc.

IN NY (718) 392-1112
41-04 35th Ave.
L.I.C., NY 11101

Specialists In:

- Site Assessment
- Remediation
- OSHA Training
- Indoor Air Quality Survey
- Industrial Hygiene
- Compliance Auditing

RSP ASSOCIATES, INC.

1 Tobey Lane ■ Wakefield, Massachusetts ■ 01880
Phone 617-224-0740 FAX 617-246-4405

Are You Dealing with an Independent Lab? You should be!



- Offering Analytical Services Nationwide
- No Conflict of Interest
- Fast, Dependable, Quality Service
- Competitive Prices
- No Hidden Costs
- Samples Archived
- **NVLAP Accredited - Laboratory #1151**
- TEM, Air, Bulk & Water
- P.M. PCM, SEM
- A.I.H.A. - Lab. #32606-CO1
- New York ELAP - Lab. #10979
- SAME-DAY Results Available
- C.I.H. Services Available
- Engineering and Consulting Services Available
- Materials Characterization by SEM

One of the Oldest, Most Reliable and Experienced Analytical Laboratories in the United States



MICRO ANALYTICAL LABORATORIES, INC.
Independent Analytical Services Nationwide

3618 N.W. 97TH BLVD., GAINESVILLE, FL 32606
(904) 332-1701 • (800) 358-3160 • FAX (904) 332-3572



Over 25 Years of Air Quality Services

- Source Testing — EPA Methods
- CEM Certification/Audits
- Ambient Air Monitoring
- Dispersion Modeling/Meteorology
- Total In-House Laboratory Capabilities

**One Research Drive
Stamford, CT 06906
(203) 325-1371 FAX: (203) 357-0166**

FLO-GAGE™



**NEW!
LARGER
SIZES**

Direct Reading, Differential Pressure Flowmeter for Liquids, Gases and Compressed Air

- Calibrated for your temperature, pressure & viscosity
- Accuracy ±3% FS
- Rugged Industrial Construction
- Large 3.5" dial (270°)
- Transmitter and Limit Switch Options
- Reed Switches

1-800-NOW-FLOW

-RCM Industries, Inc.

P.O. Box 6554 Concord, CA 94524-6554
Tel. (510)687-8363 Fax (510)671-9636

Circle 181 on card.

TRIANGLE LABS

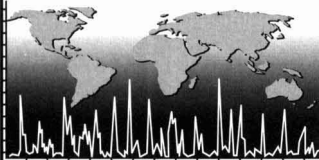

**Dioxins/Furans ▲ Volatiles
PCBs/Pesticides ▲ Metals
Semi-Volatiles ▲ PAHs**

ENVIRONMENTAL DIVISION:
801 Capitola Drive
Durham, NC 27713 USA

**TEL: 919-544-5729
FAX: 919-544-5491**

College Degrees through Distance Learning

You can earn your **B.S., M.S., or Ph.D.** degree through Home Study Education. We specialize in offering **Environmental Engineering, Occupational Safety & Health, Business Admin., and Health Administration.**

- Credit for Life/Work Experience given
- Fully Licensed and Accredited
- Affordable Tuition Plans Available

Call For Free University Catalog
800 • 977 • 8449 ext. 149

Columbia Southern University
650 South McKenzie St.
Foley, AL 36535



FILTER PRESSES

*HIGHEST QUALITY
PRICED RIGHT*



IPEC GLOBAL

TEL. (909) 930-0999
FAX. (909) 930-0900

ANALYSIS

USEPA Methods 25, 25-C, & 10-B
SCAQMD Methods 25.1 & 25.2
Methane/Ethane for TGNMO subtraction

Equipment Rental

Samplers for Methods 25, 25-C, 25.1, & 25.2
PM-10 sampler for ambient particulates
TSP sampler for ambient particulates
PUF sampler for ambient semi-volatiles



Triangle Environmental Services, Inc.
P.O. box 13294
Research Triangle Park, NC 27709
(919) 361-2890
Fax (919) 361-3474

1-800-367-4VOC's

**Classified Ads
Get Results**

ENVIRONMENTAL & SAFETY SERVICES, INC.

ENVIRONMENTAL HEALTH & SAFETY MANAGER
CERTIFICATE COURSE

Independent Study Format

- Hazardous Materials • Air Pollution Control
- CERCLA/SARA • Water Pollution Control
- Ergonomics • Plans & Programs
- Recordkeeping • Hazwoper • Hazcom • Confined Space Entry • Lockout/Tagout • Bloodborne Pathogens • Personal Protective Equipment
- RCRA/HSWA • Civil & Criminal Liability • Hazardous Waste • Medical Surveillance
- Assessments/Audits

Accredited by the National Registry of Environmental Professionals for Registered Environmental Manager (REM) and recognized by the Institute of Hazardous Materials Management for Certified Hazardous Material Manager (CHMM). Also CEUs from UNC system.

PRICE: \$595.00 (all materials included)
CALL OR WRITE FOR DETAILS (910) 763-6999
Box 3394 Wilmington, NC 28406

**NEED DRUMS TOMORROW?
CALL TOLL-FREE TODAY!
1-800-366-7044**

- STAINLESS STEEL DRUMS
- STEEL DRUMS
- POLYETHYLENE DRUMS
- SALVAGE & OVERPACK DRUMS
- PAIS AND CANS
- FIBER DRUMS
- HAZARDOUS WASTE DRUMS
- DRUM ACCESSORIES



54 Veronica Ave • P.O. Box 6140
Somerset, New Jersey 08875-6140
TEL: 908/435-0020 • FAX: 908/435-0040
OUR REPUTATION IS STAINLESS.

**Fax Us Your Ad Today
817-662-7075**

Flowmeter Rentals & Services

PSC offers short term rental & technical services using precision portable non-intrusive flow or energy flowmeters for Water & Energy Conservation Surveys or to verify compliance to EPA requirements, as well as:

- Leak Detection
- Balancing
- Calibration

Performance Survey Corporation

155 Plant Ave., Hauppauge, NY 11788
1-800-275-8478 Fax (516) 231-3334

FIELD KITS

SW846-accepted immunoassays for:

- 2,4-D
- PAH
- DDT
- PCB...and more!

For listing, call
1-800-MILLIPORE, ext. 8003
MILLIPORE

SALVAGE CHEMICALS BOUGHT

Chemicals, Freons, Resins, Solvents, Plastics, Exotic Metals, Borates, Ions, Genesolves, Oils, Dyes, Spool Ends, Oxides. Also: Advanced Composites (Kevlar, Nextel, Fiberglass, Carbon Fibers, Yarns)

KEMSTAR CORP.

West: (310) 390-0180 East: (914) 681-0126
FAX: (310) 391-8143 Fax: (310) 391-8143



Mystic Air Quality Consultants, Inc.

NEAR FOXWOODS CASINO IN CT

LEAD, ASBESTOS, HAZMAT TRAINING COURSES
REFRESHMENTS INCLUDED
OUR PLACE OR YOURS

CT, NY, RI APPROVALS
EPA LISTED, MAP CERTIFIED

(800) 247-7746

AIR DISPERSION MODELING COURSES.

Practical, "how to" courses customized to your local area, including state permitting, Title III, New ISCT3, Complex Terrain and PSD Permits modeling courses also conducted.

Atlanta GA: 1/15-19 Chicago IL: 3/25-29 Los Angeles CA: 5/13-15
Newark NJ: 2/21-23 New Orleans LA: 5/6-8 RTP NC: 6/3-6
Tampa FL: 3/11-13

BEE-LINE TRAINING



214/BEE-LINE Fax 214/BEE-FAXX

Hazardous Waste Drums Specializing in Overpacks

U.N. APPROVED DRUMS

New and Reconditioned Steel • Plastic •
Fiber • 5 to 110 Gallons
NO ORDER TOO SMALL

One Drum to Truckloads Shipped Anywhere
Prices Depend on Quantity

If we do not stock a special drum, we will get it for you.

JAMES T. WARRING SONS, INC.
4545 "S" Street, Capital Heights, MD 20743
(301) 322-5400 — (301) 925-8874 FAX

*What you NEED...
When YOU need it.*

Isokinetic Testing & CEM Support Equipment

Model 522
Meter Console

APEX ANALYTICAL EQUIPMENT COMPANY
INSTRUMENTS

(919) 557-7300
(800) 882-3214
FAX (919) 557-7110

There are two ways to manage your Environmental Compliance Headaches...

1. Take Care of the Symptoms



2. Take Care of the Problem



Industrial Clean-up & Remediation

Mobile Sludge Dewatering

Dredging

Tank Management

Transportation & Disposal

800-327-1979

for information on how to protect your interests

Circle 182 on card.

Get BIG Results in a small space

A 50-Year Traditional of Engineering Excellence

Engineers, Architects and Planners



Offices throughout the U.S. and Europe

P.O. Box 15040 York, PA 17405-7040 • 800-274-2224

Environmental PROTECTION

1996
rates

CLASSIFIED

1" \$155 3" \$465
2" \$310 4" \$620

PROFESSIONAL DIRECTORY

1" \$ 905 .. \$1705
2" \$1660 .. \$3065
3" \$2435 .. \$4485
4" \$3195 .. \$5780

For Assistance Contact
Debbie Orr
Eastern Region

LeAndrea Warren
Central & Western Regions

(817) 662-1134
FAX (817) 662-7073

PRODUCT LITERATURE



continued from page 73
Environmental Monitoring Equipment
 HAZCO Services, the nation's leading instrument rental, sales and repair company, offers its 1995-96 324-page catalog featuring air monitors and samplers, gas detectors, water quality instruments, sampling equipment, safety supplies and decon/lab trailers for the environmental industry. HAZCO services its clients through 12 nationwide locations, same-day shipments and premier customer service.
HAZCO Services, Inc.
 2066 Springboro West
 Dayton, OH 45439
 (800) 332-0435
 Fax (513) 293-9227

Circle 118 on card.



Earthprobe 200
 This self-contained all hydraulic rig meets the growing demand for direct push/probing technology for taking soil, water or vapor samples. The Earthprobe 200 is ruggedly built and can be mounted in any suitably-sized pickup truck. Advanced hydraulics allow precise control over the feed and hammering functions. The mast tilts for angle probing. The optional rotary head provides limited auger drilling capability.
SIMCO
 (800) 338-9925

Circle 119 on card.

UNITED STATES POSTAL SERVICE
Statement of Ownership, Management, and Circulation
 (Required by 39 U.S.C. 3685)

1. Publication Title: ENVIRONMENTAL PROTECTION

2. Publication No.: 0 0 6 - 7 0 3

3. Filing Date: 9/29/95

4. Issue Frequency: Monthly

5. No. of Issues Published Annually: 12

6. Annual Subscription Price: \$ 113.00

7. Complete Mailing Address of Known Office of Publication (Street, City, County, State, and ZIP+4) (Not Printer):
 3630 IH 35 Waco, McLennan, Texas 76706

8. Complete Mailing Address of Headquarters or General Business Office of Publisher (Not Printer):
 SAME

9. Full Names and Complete Mailing Addresses of Publisher, Editor, and Managing Editor (Do Not Leave Blank):
 Publisher (Name and Complete Mailing Address):
 Dick Young One Northfield Plaza, Ste. 300 Northfield, IL 60093
 Editor (Name and Complete Mailing Address):
 Ellen Carnevale National Press Building 529 14th Street, NW, Ste 1170 Washington, DC 20045-2101
 Managing Editor (Name and Complete Mailing Address):

10. Owner (If owned by a corporation, its name and address must be stated and also immediately thereafter the names and addresses of stockholders owning or holding 1 percent or more of the total amount of stock. If not owned by a corporation, the names and addresses of the individual owners must be given; if owned by a partnership or other unincorporated firm, its name and address as well as that of each individual must be given. If the publication is published by a nonprofit organization, its name and address must be stated.) (Do Not Leave Blank):

Full Name	Complete Mailing Address
Stevens Publishing Corporation	3630 IH 35 Waco, Texas 76706
Craig S. Stevens	2701 Cresthill Circle Waco, Texas 76710
Barbara S. Stevens	2701 Cresthill Circle Waco, Texas 76710

11. Known Bondholders, Mortgagees, and Other Security Holders Owning or Holding 1 Percent or More of Total Amount of Bonds, Mortgages, or Other Securities. If none, check box None

Full Name	Complete Mailing Address
NONE	

12. For completion by nonprofit organizations authorized to mail at special rates. The purpose, function, and nonprofit status of this organization and the exempt status for federal income tax purposes. (Check one) Has Not Changed During Preceding 12 Months Has Changed During Preceding 12 Months (If checked, publisher must submit explanation of change with this statement)

PS Form 3526, October 1994 (See Instructions on Reverse)

13. Publication Name: ENVIRONMENTAL PROTECTION

14. Issue Date for Circulation Data Below: 9/27/95

15. Extent and Nature of Circulation

	Average No. Copies Each Issue During Preceding 12 Months	Actual No. Copies of Single Issue Published Nearest to Filing Date
a. Total No. Copies (Net Press Run)	100599	97651
b. Paid and/or Requested Circulation (1) Sales Through Dealers and Carriers, Street Vendors, and Counter Sales (Not Mailed)	-	-
(2) Paid or Requested Mail Subscriptions (Include Advertisers' Proof Copies/Exchange Copies)	92418	92508
c. Total Paid and/or Requested Circulation (Sum of 15b(1) and 15b(2))	92418	92508
d. Free Distribution by Mail (Samples, Complimentary, and Other Free)	3813	3533
e. Free Distribution Outside the Mail (Carriers or Other Means)	-	-
f. Total Free Distribution (Sum of 15d and 15e)	3813	3533
g. Total Distribution (Sum of 15c and 15f)	96231	96041
h. Copies Not Distributed (1) Office Use, Leftovers, Spoiled	4368	1610
(2) Return from News Agents	-	-
i. Total (Sum of 15g, 15h(1), and 15h(2))	100599	97651
Percent Paid and/or Requested Circulation (15c/15g x 100)	92%	95%

16. This Statement of Ownership will be printed in the 52nd, 95 issue of this publication Check box if not required to publish.

17. Signature of Editor, Publisher, Business Manager, or Owner: *Craig Stevens* President Date: 9/27/95

I certify that all information furnished on this form is true and complete. I understand that anyone who furnishes false or misleading information on this form or who omits material or information requested on the form may be subject to criminal sanctions (including fines and imprisonment) and/or civil sanctions (including multiple damages and civil penalties).

Instructions to Publishers

- Complete and file one copy of this form with your postmaster on or before October 1, annually. Keep a copy of the completed form for your records.
- Include in items 10 and 11, in cases where the stockholder or security holder is a trustee, the name of the person or corporation for whom the trustee is acting. Also include the names and addresses of individuals who own or hold 1 percent or more of the total amount of bonds, mortgages, or other securities of the publishing corporation. In item 11, if none, check box. Use blank sheets if more space is required.
- Be sure to furnish all information called for in item 15, regarding circulation. Free circulation must be shown in items 15d, e, and f.
- If the publication had second-class authorization as a general or requester publication, this Statement of Ownership, Management, and Circulation must be published; it must be printed in any issue in October or the last printed issue after October, if the publication is not published during October.
- In item 16, indicate date of the issue in which this Statement of Ownership will be printed.
- Item 17 must be signed.

Failure to file or publish a statement of ownership may lead to suspension of second class authorization.

PS Form 3526, October 1994 (Reverse)

FACT

in 1994 *Environmental Protection* published 1.68 times more feature article pages than any other broad-based environmental magazine

Environmental PROTECTION

AD INDEX

Circle	Advertisers	Page #	Circle	Advertisers	Page #	Circle	Advertisers	Page #
31	Aero Tec Labs	45	39	PE Photovac	51	107	Solinst	115
34	Air & Waste Management Assn.	47	47	PE Photovac	57	93	Texas Workers Insurance Fund	98
102	American Mobile Satellite Corp.	164	25	PSG	38	82	Turner Designs	83
60	American Safety Risk Retention	65	65	RM Young	67	106	Von Roll/WTI	115
17	A.O. Smith Harvestore Products	29	75	Rotronix Instrument Corp.	64	Product Literature		
8	Applied Automation	14	26	Safety Storage Inc.	39	117	Airborne Environmental Surveys	73
4	Ashland Chemical Company	7	64	Softshel, Inc.	67	116	Cole Parmer	73
47	Auburn International	69	68	Solinst	69	115	Hartzell Fan	73
62	Badger Meter	53	103	Stevens Direct Link	162	118	Hazco	161
32	Brown Bear	46	50	Stevens Publishing Book Division	58-59	119	Simco	161
54	Michael Byrne Manufacturing	63	12	Structural North America	22	Products & Services		
16	Cinc	25	73	Testo	72	127	Automatic Filters Inc.	67
41	Clements Associates	52	69	Texas Workers Insurance Fund	70	133	Bacharach	68
3	CNA Insurance	4	28	Tracer Research	41	131	Barnant Company	68
13	Counterpoint Publishing	23	20	TRC Environmental	32	152	BNFL Instruments	72
9	CPI Electronic Publishing	15	11	Turner Designs	21	148	CEA Instruments Inc.	71
66	Department of Navy	68	5	Vista Information Solutions Inc.	8	149	CHEMetrics	71
35	Dieterich Standard	48	36	Von Roll/WTI	48	135	Clean Gas Systems Inc.	68
44	ECS Underwriting	55	160	Weather Network	57	132	Clements Associates Inc.	68
24	EJ Krause & Assoc.	37	Buyer's Guide Section			151	Dakota Software Corporation	72
46	Environmental Profiles	57	81	ABB Air Preheater Inc.	81	142	Donaldson Company Inc.	70
18	ERIIS	30	84	American Safety Risk Retention	84	128	Drexelbrook Engineering Co.	67
71	Exploration Products	71	76	A.O. Smith Harvestore Products	74	137	Envirex	69
74	Flo Trend Systems	64	111	Applied Automation	120	129	EnviroMetrics Software Inc.	67
52	Goal Line Environmental Technologies	61	83	Brown Bear	84	140	Environmental Monitor Service	69
2	The Gorman-Rupp Company	3	99	Climatronics	110	139	Environmental Supply Company Inc.	69
6	Graseby	9	98	CNA Insurance	107	153	Flomatic	72
22	Harding Lawson Associates	34	114	Counterpoint Publishing	150	154	General Resource Corp.	72
72	Haz Safe	72	110	CPI Electronic Publishing	119	150	George Fischer Inc.	71
30	Haz-Stor	45	91	Environmental Profiles	94	122	Goal Line	65
27	Hydrolab Corp.	40	90	Flo Trend Systems	91	136	Haz-Safe Buildings by Design	69
19	In-Situ, Inc.	31	97	The Gorman-Rupp Company	102	143	HNU Systems Inc.	70
23	Integrated Environmental Solutions	35	88	Graseby	89	147	Immagic Inc.	71
101	Invitro International	163	92	Haz Safe	94	124	Intergraph	65
10	Jaeger Products Inc.	19	104	Haz-Stor	114	125	J.T. Baker	65
7	Legi-Slate	10	109	Hydrolab Corp.	118	141	Milltronics	70
53	Leybold Inficon	66	108	Leybold Inficon	117	130	Myron L Company	67
62	Liquid Waste Technology	65	86	Integrated Environmental Solutions	87	123	Omega	65
38	Logical Technology	49	100	Legi-Slate	113	120	Pacific Environmental Services	64
29	Met One	43	94	Logical Technology	99	145	Pneumafil Corporation	70
14	MMC International	24	85	Met One	85	138	RegScan Inc.	69
33	Mobile Process Technology	46	113	Mobile Process Technology	127	126	Sigma	65
37	New Pig Corp.	49	95	New Pig Corp.	99	134	Solinst	68
70	Oil Skimmers	71	87	Pacific Environmental Services	88	155	Spectra-Tech Inc.	72
1	Omega Engineering Inc.	2	112	PSG	121	144	SRS Industrial Engineering Inc	70
15	Osmonics Inc.	25	105	RM Young	114	146	Total Containment	71
45	Pacific Environmental Services	56	80	Safety Storage Inc.	79	121	U.S. Environmental Engineering	65
40	Pallflex	52	96	SAMSCO, Inc.	101			
			89	Softshel, Inc.	91			



COMING SOON TO A PHONE NEAR YOU...

DirectLink

24 Hour Access to Product & Service Information.

The business world never stops. With **DirectLink**, even if you want information outside normal business hours you can get it... when you want it...at no cost to you.

You now have the opportunity to interface with advertisers 24 hours a day with **DirectLink's** interactive system from Stevens Publishing. You call a toll-free 800 number, enter the 4 digit ad code and hear a 30-second message from the company. You can get product information faxed to you — instantly! Connect directly to the advertiser, its nearest distributor, or you can even leave a voice mail message.

Look for this symbol. You will find it in advertisements that have **DirectLink**.

Stevens DirectLink — The Newest State-of-the-Art Interactive Service from Stevens Publishing Corp.

DirectLink

IS EASY TO USE!

1. Dial the 800#
2. Enter the 4-digit advertiser code
3. Listen to the audio message

You are then prompted to...

- a. Get product information by fax.
- b. Connect directly to the advertiser or the nearest distributor.
- c. Leave a voice mail message.



DirectLink

24 HOUR PRODUCT INFORMATION
For immediate information
call 1-800-xxx-xxxx
and enter code xxxx.



NO POSTAGE
NECESSARY
IF MAILED
IN THE
UNITED STATES

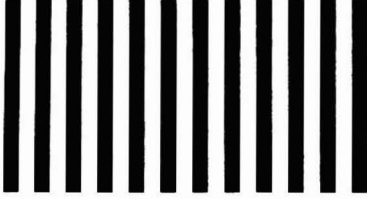

BUSINESS REPLY MAIL
FIRST CLASS PERMIT NO. 1791 WACO, TX

POSTAGE WILL BE PAID BY ADDRESSEE

Stevens Publishing
Environmental
PROTECTION
Reader Service
Management Department
P.O. Box 2573
Waco, TX 76702-9910



Environmental PROTECTION

January 1996
Card Expires March 1996
Reader Service Card
035709601060

FREE INFORMATION

For FREE information on products advertised in this issue, circle their Reader Service Number on the card below. Please type or print clearly and answer all the questions on the card.

PLEASE SEND ME FREE INFORMATION ON THE FOLLOWING ITEMS:

1	2	3	4	5	6	7	8	9	10	11	12	13	14	15	16	17	18	19	20
21	22	23	24	25	26	27	28	29	30	31	32	33	34	35	36	37	38	39	40
41	42	43	44	45	46	47	48	49	50	51	52	53	54	55	56	57	58	59	60
61	62	63	64	65	66	67	68	69	70	71	72	73	74	75	76	77	78	79	80
81	82	83	84	85	86	87	88	89	90	91	92	93	94	95	96	97	98	99	100
101	102	103	104	105	106	107	108	109	110	111	112	113	114	115	116	117	118	119	120
121	122	123	124	125	126	127	128	129	130	131	132	133	134	135	136	137	138	139	140
141	142	143	144	145	146	147	148	149	150	151	152	153	154	155	156	157	158	159	160
161	162	163	164	165	166	167	168	169	170	171	172	173	174	175	176	177	178	179	180
181	182	183	184	185	186	187	188	189	190	191	192	193	194	195	196	197	198	199	200

Please peel address label from cover and affix below. For faster service photocopy this side only and send to our FAX # (817) 662-7075.

NAME _____

TITLE _____

COMPANY _____

ADDRESS _____ Home Bus.

CITY _____ STATE _____ ZIP _____

- YES, I would like to receive/continue to receive *Environmental Protection*.
- NO, I'm not interested at this time.

Signature _____ **Signature Required** Date _____
For FREE Subscription

Title _____

Business Phone (____) _____ FAX No. (____) _____

Home Phone (____) _____

1. Function which best describes your activity in Pollution Control (check only one):

- A Corporate responsibility for Pollution Control
 B Manage all Pollution Control Operations at this location
 C Supervise sub-group in Pollution Control Operations
 D Provide professional consulting service on Pollution Control
 E Provide staff environmental service on Pollution Control
 Z Other (please specify) _____

3. Approximate number of employees at this address (check only one):

- A 1-19 E 250-499 H 1500-2499
 B 20-49 F 500-999 I 2500 and up
 C 50-99 G 1000-1499 D 100-249

2. Type of Business (check only one):

A Manufacturing. If manufacturing, please check the appropriate SIC (check only one):

- | | |
|--|--|
| <input type="checkbox"/> (20) Food | <input type="checkbox"/> (30) Rubber/Plastic |
| <input type="checkbox"/> (21) Tobacco | <input type="checkbox"/> (31) Leather |
| <input type="checkbox"/> (22) Textile | <input type="checkbox"/> (32) Stone/Clay/Glass |
| <input type="checkbox"/> (23) Apparel | <input type="checkbox"/> (33) Primary Metal |
| <input type="checkbox"/> (24) Lumber & Wood | <input type="checkbox"/> (34) Fab. Metal |
| <input type="checkbox"/> (25) Furniture | <input type="checkbox"/> (35) Mach., except Elect. |
| <input type="checkbox"/> (26) Paper | <input type="checkbox"/> (36) Elect. & Electron. Mach. |
| <input type="checkbox"/> (27) Print/Publish | <input type="checkbox"/> (37) Trans. Equip. |
| <input type="checkbox"/> (28) Chemicals | <input type="checkbox"/> (38) Instru/meas/analyz/controlling |
| <input type="checkbox"/> (29) Petrol. & Coal | <input type="checkbox"/> (39) Miscellaneous Mfg. |

4. In your job function do you recommend, specify or purchase? (check all that apply):

- A Pollution Control Equipment
 B Instrumentation
 C Chemicals
 D Parts & equipment for maintenance operation and control
 E Services/Consulting
 F None of the above _____
 (please specify)

5. What types of Pollution Control are you responsible for? (check all that apply):

- A Air F Toxic & hazardous materials
 B Water G Energy control/energy conservation
 C Noises H None of the above
 D Solid waste disposal (please specify)
 E Industrial hygiene

6. Which of the following publications do you receive personally addressed to you? (check all that apply):

- A Pollution Engineering
 B Environment Today
 C Environmental Solutions
 D Pollution Equipment News
 E The National Environmental Journal
 F Water Environment & Technology
 G None of the above _____
 (please specify)

- B Mining
 C Agriculture
 D Engineering & Contracting
 L Consulting
 M Insurance
 E Utilities, public, private & cooperative
 F Govt. including municipal or district sanitary water or wastewater trmnt. sys. or plants

Type of Govt:

- G City H County
 I State J Federal
 K Transportation
 N Labs O Training P Real Estate
 Z Misc. Services _____
 (please specify)



CHANGE THE DIRECTION OF YOUR BUSINESS IN AS LITTLE AS 3 MINUTES.

CORROSITEX® saves your business time and money by enabling you to accurately and efficiently package and ship hazardous materials.

CORROSITEX® quickly delivers the accurate information you need to correctly package and ship corrosive and non-corrosive materials – eliminating the expense of inappropriate overpacking and the potential risk of underpacking. And today CORROSITEX offers even greater value. New product enhance-

ments heighten accuracy and an expanded exemption from the DOT eliminates any need for costly and time-consuming animal testing for corrosive and non-corrosive materials. Accuracy, efficiency and value in just a few minutes to a few hours. CORROSITEX. The simple and definitive information tool that makes you right the first time.

CORROSITEX®

For Information Call 1-800-2-INVITRO
(1-800-246-8487)

Accurate information is good business.

Circle 101 on card.

INVITRO
INTERNATIONAL

16632 Millikan Ave., Irvine, CA 92714 CORROSITEX is a registered trademark of InVitro International. © 1995 InVitro International

Introducing The First Affordable Go-Anywhere

Satellite Phone With Dispatch Option



This is not a cellular phone. This is the latest in satellite communications technology that works virtually everywhere in North America and hundreds of miles off-shore. No roaming complications or expenses—the SKYCELLSM Service Satellite Phone works directly off of the SKYCELL Service satellite and with the public telephone network. Make and receive calls as easily as with the phone in your home or office. This phone easily installs in any vehicle.

Optional Satellite Dispatch Service. In addition to satellite telephone service, you can now benefit from dispatch communications without ground tower coverage limitations. Design your own private talk groups within any one of our four Ultra-Wide Area Zones which collectively cover the entire United States. For one low monthly fee, your talk time is unlimited! And all of your talk groups are completely private -- only those units in the select talk group can hear the conversation. Call to find out more about the most revolutionary communications service available today.



1 - 8 0 0 - 7 5 5 - 7 3 7 3
ext. 1111

SKYCELLSM

Satellite Telephone Service

Circle 102 on card.



- 4 at 2045